

AGENDA
DESIGN STANDARD MANUAL
PROFESSIONAL ADVISORY COMMITTEE
November 7, 2016–9:00 a.m.
Escambia County Central Complex Building
3363 West Park Place

1. Call to Order
2. Sunshine Law presentation by Meredith D. Crawford, County Attorney's Office.
3. Items for Discussion
 - A. Design Standard Manual Changes, Chapter 1
 1. Drainage right-of-way
 2. Roadway elevation
 3. Sidewalks
 - B. DSM Chapter 3, Low Impact Development (New)
Low Impact Development (New)
 - C. LDC Chapter 2, Department Checklist language
Department checklist for preliminary plats and final plats.
4. Scheduling of the next DSM-PAC meeting.
5. Adjournment.

DSM Professional Advisory Committee

3. A.

Meeting Date: 11/07/2016

Submitted By: Allyson Cain, Development
Services

Information

Recommendation:

1. Drainage right-of-way
2. Roadway elevation
3. Sidewalks

Attachments

Chapter 1 Changes

Escambia County Design Standards Manual

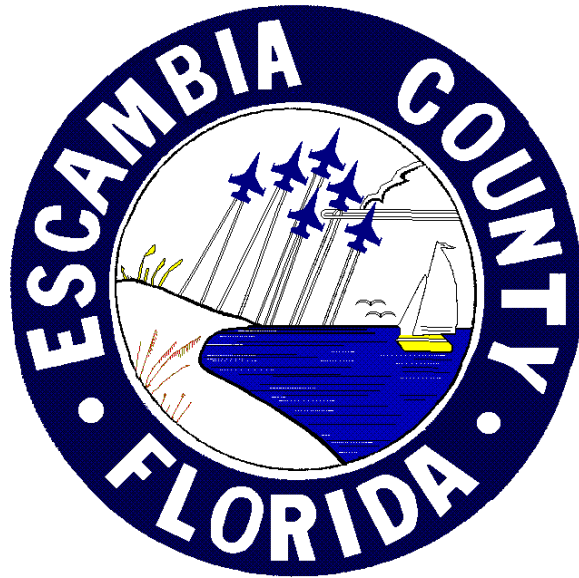

10/2016

Draft

Design Standards Manual

1
2
3
4
5
6
7
8
9
10
11
12
13
14
15
16
17
18
19
20
21
22
23
24
25
26
27
28
29
30
31
32
33
34
35
36
37
38
39
40
41
42
43
44
45
46
47
48

Chapter 1, Engineering

Article 1 Stormwater

Sec. 1-1 Stormwater Management Systems

- Sec. 1-1.1 Stormwater Quality (treatment)
- Sec. 1-1.2 Stormwater Quantity (attenuations)
- Sec. 1-1.3 Stormwater Ponds and Impoundments
- Sec. 1-1.4 Pond Slopes and Maintenance Access
- Sec. 1-1.5 Conveyance Systems
- Sec. 1-1.6 Exemptions
- Sec. 1-1.7 Other Agency Approvals

Sec. 1-2 Stormwater Management Plans

- Sec. 1-2.1 Methods
- Sec. 1-2.2 Content

Article 2 Transportation

Sec. 2-1 Roadway Design

- Sec. 2-1.1 Minimum Right-of-way widths
- Sec. 2-1.2 Minimum pavement widths
- Sec. 2-1.3 Intersections
- Sec. 2-1.4 Slopes
- Sec. 2-1.5 Roadway Elevations
- Sec. 2-1.6 Street Layout
- Sec. 2-1.7 Traffic Control Devices

Sec. 2-2 Access Management

- Sec. 2-2.1 Access Location
- Sec. 2-2.2 Pedestrian Access
- Sec. 2-2.3 Traffic Control
- Sec. 2-2.4 Modification of Existing access
- Sec. 2-2.5 internal Site Access Design
- Sec. 2-2.6 Commercial Traffic in Residential Areas

Article 3 Parking

Sec. 3-1 Parking and Loading

- Sec. 3-1.1 Stall and aisle design
- Sec. 3-1.2 Parking Demand
- Sec. 3-1.3 Off-Site and Joint Use Parking
- Sec. 3-1.4 Loading and Unloading

1 **CHAPTER 1, Engineering**

2 **Article 1 - STORMWATER**

3 **1-1 Stormwater Management Systems**

4 All projects requiring a Stormwater Management System (SMS) shall be designed to meet
5 the following:

6 **1-1.1. Stormwater Quality (treatment)**

7 Projects that require a Stormwater Management System (SMS) shall at a minimum be
8 **designed** to provide for the treatment of the first ½” of runoff which shall be recovered in 72
9 hours. The method of treatment shall comply with the design methods referenced in the latest
10 edition of the Environmental Resources Permit Applicants Handbook Volume II.

11 **1-1.2. Stormwater Quantity (attenuation)**

12 Projects that require a Stormwater Management System (SMS) shall at a minimum be
13 **designed** to provide for the following for the total contributing runoff area:

14 Provide attenuation of the runoff from a 100 year critical duration event, up to and including
15 24 hour duration, so that the post-development runoff rate does not exceed the pre-
16 development runoff rate, when a positive discharge route is present.

17 or

18 Drainage systems in areas with no positive drainage outlet shall be designed to more
19 stringent criteria to include retention up to and including twenty-four (24) hour, one hundred
20 (100) year frequency storm with no offsite discharge. These systems shall remain private and
21 will not be accepted by the county for ownership and maintenance.

22 or

23 For projects that abut the Gulf of Mexico, Escambia Bay, Pensacola Bay, Perdido Bay or their
24 connected, tidally influenced bodies of water (i.e. Tarkiln Bayou, Chico Bayou, Bayou Texar,
25 etc.) the County Engineer may reduce or waive the SMS from Stormwater Quantity
26 requirements.

27 **1-1.3 Stormwater Ponds and Impoundments**

28 All stormwater ponds or impoundments shall comply with the design standards provided in
29 the Environmental Resource Permitting Applicants Handbook, Volume II, Florida Department
30 of Environmental Protection and Northwest Florida Water Management District.

31

32 **Sec. 1-1.4 Pond Slopes, Fencing, and Maintenance Access**

33 All ponds - Retention and detention sides shall slope at a gentle grade into the water as a
34 safeguard against accidents, to encourage the growth of vegetation, allow for proper
35 maintenance, and to allow alternate flooding and exposure of areas along the shore as water
36 levels change.

37

38

1
2 **(a) Residential Subdivisions (private and public)**
3

4 **(1) Side slopes**

- 5 a. Wet ponds - When unfenced, side slopes shall not be steeper than 4:1
6 (horizontal to vertical) out to a depth of two (2) feet below the control elevation.
7 When fenced, side slopes shall not be steeper than 3:1 out to a depth of two
8 feet below the control elevation.
9 b. Dry ponds - Side slopes may not be steeper than 3:1, and must be fenced when
10 steeper than 4:1 (horizontal to vertical).

11 **(2) Fencing** - The required fence shall be six (6) feet high chain link meeting County
12 technical specifications¹ and be installed along the perimeter of the pond parcel.
13 Privacy fencing, or other fencing, may be used to supplement screening to the
14 chain link fence provided it is located within a private fence easement and offset by
15 a minimum of five (5) feet from the chain link fence for maintenance.

16 **(3) Stabilization**

- 17 a. Wet ponds - Wet ponds shall be stabilized in solid sod above the permanent
18 pool elevation, unless stabilization is obtained through incorporation of a-littoral
19 plantings.
20 b. Dry Ponds - Side slopes shall be solid sod from the bottom to three (3) feet
21 beyond the top of bank

22 **(4) Maintenance access shall meet the following criteria:**

- 23 a. Unobstructed access with a minimum width of fifteen (15) feet to the wet/dry
24 pond area constructed of graded aggregate a minimum twelve (12) feet wide,
25 no steeper than 6:1 (horizontal to vertical) at least five (5) inches thick, and
26 underlain with pervious geotextile fabric.
27 b. A concrete driveway from the roadway meeting County standards
28 c. Minimum fourteen (14) feet wide, six (6) feet tall double access gate at the pond
29 parcel boundary line.
30 d. Dry ponds shall include a minimum twelve (12) feet wide access road into the
31 bottom of the retention/detention basin no steeper than 6:1. The access shall
32 be unobstructed and constructed of graded aggregate a minimum of five (5)
33 inches thick, and underlain with pervious geotextile fabric.
34 e. Wet ponds shall have a minimum fifteen (15) feet wide access route around the
35 top bank perimeter of the retention area with a cross slope no steeper than 6:1.
36 Access onto the perimeter route shall have a slope no steeper than 6:1.

37
38 **(b) Commercial and industrial sites and subdivisions**
39

40 **(1) Private developments**

- 41 a. Side slopes - Wet or dry ponds. Stormwater basins designed to collect more
42 than two (2) feet of water must contain side slopes that are not steeper than 4:1
43 (horizontal to vertical) out to a depth of two feet below the control elevation
44 unless fenced to restrict public access.
45 b. Fencing – Per engineer of record
46 c. Stabilization – Per engineer of record
47 d. Maintenance access – Per engineer of record
48

1 (2) Public developments -

2 a. Side slopes

3 1. Wet ponds - When unfenced, side slopes shall not be steeper than 4:1
4 (horizontal to vertical) out to a depth of two (2) feet below the control
5 elevation. When fenced, side slopes shall not be steeper than 3:1 out to a
6 depth of two feet below the control elevation.

7 2. Dry ponds - Side slopes may not be steeper than 3:1, and must be fenced
8 when steeper than 4:1 (horizontal to vertical).

9 b. Fencing - The required fence shall be six (6) feet high chain link meeting
10 County technical specifications¹ and be installed along the perimeter of the
11 pond parcel. Privacy fencing, or other fencing, may be used to supplement
12 screening to the chain link fence provided it is located within a private fence
13 easement and offset by a minimum of five (5) feet from the chain link fence for
14 maintenance.

15 c. Stabilization

16 1. Wet ponds - Wet ponds shall be stabilized in solid sod above the
17 permanent pool elevation, unless stabilization is obtained through
18 incorporation of littoral plantings.

19 2. Dry Ponds - Side slopes shall be solid sod from the bottom to three (3) feet
20 beyond the top of bank.

21 a. Maintenance access - Required (See requirements for maintenance
22 access, this section).

23
24 http://www.myescambia.com/sites/myescambia.com/files/Escambia%20County%20Technical%20Specifications_02-01-15.pdf
25

26 **1-1.5 Conveyance Systems**

27 All conveyance systems shall be **designed** to convey the runoff from a 25 year critical
28 duration event.

29 **(a) Curb & Gutter Systems**

30 These systems shall be **designed** to convey runoff without exceeding the following:

31 1. For *Local Residential Roads*, the maximum allowable spread shall not overtop
32 the top of curb and the flow spread should not exceed to the crown of the
33 roadway.

34 2. For two lane *Collector Roads*, the maximum allowable spread shall not overtop
35 the top of curb and the flow spread must leave one lane of free of water in one
36 direction.

37 3. For *Arterial Roads*, the maximum allowable spread shall not overtop the top of
38 curb and the flow spread must leave at least one lane free of water in both
39 directions.

40 **(b) Roadside swales and ditches**

41 1. Shall be **designed** so that flow shall not extend over the property line, right-of-
42 way line, or drainage/utility easement line.

- 1 2. All proposed swales and open ditches shall be **designed** to have a minimal
- 2 longitudinal slope of 0.30%.
- 3 3. Shall not have a depth of greater than 3 feet.
- 4 4. Shall be designed to have a minimum distance of 6 feet from the edge of the
- 5 travel lane.
- 6 5. Shall not have a design velocity of greater than 3 feet per second unless the
- 7 swale is lined and shall not have a design velocity of greater than 6 feet per
- 8 second.

9 **(c) Open Channels in drainage right of ways or easements**

- 10 1. All ditches or swales shall be stabilized.
- 11 2. Bank slopes shall be 6:1 or flatter, unless permanent stabilization is provided.
- 12 3 Velocity of water shall not exceed three feet per second in grassed ditches or
- 13 six feet per second in lined ditches.
- 14 4. Maximum allowable design depth of water in ditches shall be three feet during a
- 15 25-year storm.
- 16 5. Bottom of ditch or swale is two inches or more above the water table.
- 17 6. Any ditches with grades of five percent or greater shall be lined or otherwise
- 18 improved so as to eliminate erosion and sedimentation buildup in the lower
- 19 elevations of the ditch, as approved by the County Engineer.
- 20 7. Adequate access for maintenance equipment (15 feet wide minimum) must be
- 21 provided as needed for maintenance equipment access.
- 22 8. Channels under ALL proposed roads shall be designed to convey the runoff
- 23 from a 100 year critical duration event without overtopping the road

24 **(d) Underground conveyance systems**

- 25 1. Inlet/Junction Box spacing shall not exceed 400 linear feet.
- 26 2. Pipe diameters shall be equal to or larger than the adjoining upstream pipe
- 27 diameter.
- 28 3. The minimum pipe size shall be 18" in diameter or its equivalent arch or
- 29 elliptical pipe.
- 30 4. Only Reinforced Concrete Pipe (RCP) shall be constructed under all proposed
- 31 or existing paved roadways.
- 32 5. Proposed drainage easements for underground conveyance systems shall have
- 33 a minimum width of 15 feet for when the proposed depth is equal to or less than
- 34 5 feet from pipe invert to proposed finished grade. Conveyance systems greater
- 35 than 5 feet in depth from pipe invert to proposed finished grade shall be located
- 36 in a drainage easement. Drainage easements shall have a 20' minimum width.
- 37 6. County Standard Inlet Capacities. Under normal flood conditions County
- 38 standard inlets are designed to accept the following flowrates:
- 39 Type "A" Inlet 7-10 cfs

1	Type "A-1" Inlet	7-10 cfs
2	Type Modified "A" Inlet	14-20 cfs
3	Double "A" Inlet	14-20 cfs

4
5 FDOT inlets may be used as a substitute for County Standard Inlets provided
6 the inlet capacity is accommodated by the specified inlet type.

7 **(e) Minimum right-of-way widths for drainage.**

8 **(1) Drainage easement.** Drainage easements must contain underground piping and
9 shall be platted to a width sufficient to accommodate the projected pipe sizes, and
10 shown on the recorded plat but in no case shall such easement be less than 15
11 feet in width unless an exception is approved by the County Engineer or designee.

12 **(2) Drainage right-of-ways.** Open ditches and drainage swales must be designed and
13 constructed within dedicated, deeded right-of-way, or parcels within a minimum
14 width of 15 feet, or sufficient width to accommodate maintenance equipment,
15 unless an exception is approved by the County Engineer or designee.

16 Exceptions to the Drainage right-of-ways under certain conditions are as follows:

17 a. Side yard drainage specific to individual lot grading purposes;

18 b. Conveyance swales or ditches for multiple lots or parcels for grading purposes
19 may be a public drainage easement, if the ditch or swale is concrete lined, a
20 bottom line concrete valley, or other types of lining that establish and set a
21 permanent elevation to prevent modifying grade slopes. Lining shall be based upon
22 velocity calculations.

23 c. A piped easement with a swale atop which meets the definition of a drainage
24 easement.

25 d. Other circumstances that would require specific approval from the County
26 Engineer or designee.

27
28 **1-1.6 Exemptions**

29
30 Projects that include the addition of 1000 sf or less of impervious surface which are not part
31 of a large development plan shall be exempt from this chapter.

32 **(a) Residential property improvements**

33 Improvements such as driveways, buildings, pools, etc. and/or accessory structures that do
34 not exceed 1500 sf shall be exempt from this chapter.

35 **(b) Minor Subdivisions**

36 Proposed subdivision of land into no more than five single-family lots, each fronting on and
37 existing paved public or private streets, and complying with all of the following:

- 38
39 1. No adverse impacts. Impervious cover on the lots will not adversely impact
40 wetlands or create adverse off-site impacts.

- 1 2. Impervious cover limits. Total lot impervious cover will not exceed 2000 square
2 feet on lots less than one acre in size, or five percent of lot area on lots one
3 acre or more.
- 4 3. Documented limits. Lot impervious cover limitations are permanently
5 documented in the public records of the county, including the subdivision plat
6 and any covenants and restrictions.
- 7 4. Positive outfall. Each lot has a positive drainage outfall

8

9 **1-1.7. Other agency approvals**

10 It is the responsibility of the applicant and the engineer of record to apply for and obtain all
11 appropriate permits. Projects that are to be dedicated to the county for ownership and
12 maintenance shall be required to provide all applicable permits prior to dedication.

13 **1-2 Stormwater Management Plans**

14 All projects requiring a Stormwater Management System (SMS) shall be required to submit a
15 Stormwater Management Plan (SMP) which shall be prepared by, signed and sealed by a
16 Professional Engineer actively registered to practice in the State of Florida. The PE shall
17 certify that the SMS has been designed to meet the SMS requirements. The SMP shall
18 include those items needed (i.e. maps, graphs, tables, calculations, photographs, narratives,
19 explanations, etc.) which clearly demonstrate the intent of the Land Development Code and
20 this Design Standards section have been met.

21 **1-2.1 Methods**

22 Innovative approaches to stormwater management are encouraged; however the SMP shall
23 document compliance with the standards of this chapter and shall demonstrate control of
24 erosion, sediment transport, stormwater quality, and stormwater quantity (flooding). Methods
25 used for other than listed below shall require approval by the county engineer:

26 *Urban Hydrology for Small Watersheds*, Technical Release 55, US Department of
27 Agriculture, Soil Conservation Service.

28 *Environmental Resource Permit Applicants Handbook*, Volumes I & II, Florida Department of
29 Environmental Protection and Northwest Florida Water Management District.

30 *Drainage Handbook: Drainage Connection Permits*, Florida Department of Transportation.

31 *Drainage Manual*, Florida Department of Transportation.

32 **1-2.2 Content**

33 At a minimum, the SMP shall provide the following information:

34 **(a) Existing Conditions**

35 All existing conditions of the project site shall be detailed and include the following:

- 36 1. Stormwater flow - the direction, flow rate, and volume of runoff pre-
37 development.
- 38 2. Offsite Contributing Area – the area, direction, flow rate, and volume of runoff
39 impacting the project site pre-development.

- 1 3. Receiving area – define or describe the area runoff flows offsite pre-
2 development. Define the positive discharge route if one exists.
- 3 4. Environmentally Sensitive Lands - Indicate the location, area and description of
4 all jurisdictional wetlands and endangered species habitat.
- 5 5. Indicate and define special flood zone areas on the site in accordance with the
6 FEMA Flood Insurance Rate Maps should they exist on the project site.
- 7 6. Vegetation – define the type and extent of existing vegetation on the project site
8 pre-development.
- 9 7. Topography – Provide a topographic map of the site pre-development. The
10 topographic survey shall be prepared by a Professional Surveyor actively
11 registered in the State of Florida. The topographic survey shall include contours
12 which extend outside the project site property lines when the line adjoins a right
13 of way, jurisdictional wetlands or easements. The requirements of this section
14 may be reduced or waived by the County Engineer.
- 15 8. Geotechnical Report –For projects proposing less than 9,000 sf of impervious
16 area, the engineer of record (EOR) may use data obtained from the NRCS Soil
17 Survey Map. For projects proposing 9,000 sf or more of impervious area, the
18 geotechnical report shall meet the requirements of the Environmental Resource
19 Permitting Applicants Handbook, Volume II.
- 20 9. Name, location and right-of-way width of all existing streets noting roadway
21 surface (paved, clay, shell, etc.), rights-of-way and platted streets within 500
22 feet of the proposed entrance(s) of the proposed subdivision.

23 **(b) Proposed Improvements**

24 All proposed alterations to the project site shall be detailed and include the following:

- 25 1. Topography – All proposed grades and contours.
- 26 2. Impervious Cover – The total areas and descriptions of proposed impervious
27 surfaces, semi-impervious surfaces, and pervious surfaces.
- 28 3. Structures – The size, location, and description of all buildings or structures.
- 29 4. Vegetation – The amount of vegetative area to be cleared.
- 30 5. Stormwater Management – All components of the proposed SMS to provide for
31 stormwater treatment and attenuation including the following:
32
 - 33 A. Plans and Specifications
 - 34 B. Calculations – showing all components of all proposed conveyance,
35 attenuation, and treatment systems meet the intent of the Land
36 Development Code and Design Standards.
 - 37 C. Erosion Control Plan – The control of erosion and sediment transport
38 shall be implemented based on the Best Management Practices (BMP's)
39 designated in the Environmental Resource Permitting Applicants
40 Handbook, Volume II, Florida Department of Environmental Protection
41 and Northwest Florida Water Management District.

1
2
3
4

- E. Maintenance Plan
- F. Overall lot grading plan for all proposed subdivisions in accordance with the Florida Building Code.

DRAFT

1 **Article 2 – TRANSPORTATION**

2 **2-1 Roadway Design**

3 All roads and bridges constructed within Escambia County, public or private, shall be
4 constructed to meet the design and materials standards identified within the DSM and
5 Escambia County Technical Specifications.

6
7 **2-1.1 Minimum right-of-way widths of streets, alleys and easements for utilities.**

8
9 *Beltways* – Beltways as designated by the County shall not be less than 300 feet wide.

10 *Arterials* - State highways and county arterials as defined in the LDC shall not be less than
11 100 feet wide.

12 *Collectors* - Collector streets, as defined in the LDC shall not be less than 80 feet wide.

13 *Local streets* - Local streets including temporary cul-de-sacs, shall be 50 feet if curb and
14 gutter are utilized, or 66 feet if roadside swales are utilized.

15
16 *Turning circles* - Turning circles (permanent) at the end of cul-de-sacs or dead-end street
17 shall have a right-of-way 100 feet in diameter.

18
19 *Easements* - Easements for utilities, where required, shall be at least ten feet wide, and
20 where practical shall be centered on rear or side lot lines.

21 *Alleys* - Alleys normally shall not be platted within subdivisions. However, where they are
22 acceptable to the overall development of a subdivision by the county engineer, they shall be
23 platted to a width of not less than 20 feet or more than 30 feet.

24 ~~*Drainage easement* - Drainage easements must contain underground piping and shall be~~
25 ~~platted to a width sufficient to accommodate the projected pipe sizes, and shown on the~~
26 ~~recorded plat but in no case shall such easement be less than 15 feet in width unless a~~
27 ~~variance is approved by the County Engineer.~~

28 ~~*Drainage right-of-ways* - Open ditches and drainage swales must be constructed within public~~
29 ~~dedicated or deeded right-of-way with a minimum width of 15 feet and shown on the recorded~~
30 ~~plat unless a variance is approved by the County Engineer.~~

31

32 **2-1.2 Minimum pavement widths**

33 The portion of pavement required to be installed at the developer's expense is set forth
34 below. As a condition of approval of new subdivisions on roadways which do not conform to
35 county standards, the developer may be required to improve the portion of said road which
36 adjoins, provides access to or is within the proposed subdivision. Improvements may include
37 installation of turning lanes, increased pavement widths, installation of drainage facilities,
38 paving or dirt roads, etc.

39 **(a Streets**

- 40 1. All proposed collector roads shall be 24 feet wide as measured from edge of pavement
41 to edge of pavement.
42 2. All proposed residential roads will be 24 feet in clearance:

- a. With curb and gutter – as measured from gutterline.
- b. With ribbon curb – as measured from back edge of ribbon curb.
- c. Or as measured from edge of asphalt to edge of asphalt.

- 3. If soil and topographic conditions and impervious areas indicate that no drainage problems will be created or aggravated, the curb and gutter requirements may be waived, and substituted with ribbon curb (or improved shoulders, four feet wide, or other stabilization methods may be used) and swales as approved by the County Engineer. The determination of whether drainage problems shall be created or aggravated will be made by the developer's registered professional engineer, subject to approval of the county engineer.

(b) Turning circles

The pavement of a turning circle at the end of a cul-de-sac or dead-end street shall have a minimum inside curb face diameter of 90 feet.

(c) Temporary turning circle

The pavement of a temporary turning circle at the end of a cul-de-sac or dead-end street shall be tangent to the boundary of the adjacent property and shall have an outside diameter of 80 feet. The County Engineer may recommend that requirements for curb and gutter around the outside of the temporary turning circle be waived.

(d) Alleys

Alleys, if approved by the County Engineer shall be paved to a width of 18 feet.

(e) Boulevards

- 1. Proposed boulevards shall have a minimum lane width clearance of 16'
 - a. With curb and gutter – as measured from gutterline.
 - b. With ribbon curb – as measured from back edge of ribbon curb.
 - c. Or as measured from edge of asphalt to edge of asphalt.
- 2. The proposed island or traffic separator shall have a minimum width of 4 feet.

2-1.3 Intersections

(a) Angle

Proposed streets shall intersect one another within ten degrees of right angles as topography and other limiting factors of good design permit.

(b) Radii

Street right-of-way intersections and edge of pavement intersections shall be rounded by radii of 25 feet minimum.

(c) Sight distance at intersections

Intersections should be designed to provide site distance considerations in accordance with FDOT standards.

1 **(d) Sight triangle requirements**

2 At a minimum, a site triangle shall be provided 35' from edge of pavement to 35' edge of
3 proposed road or driveway.

4

5 **2-1.4 Slopes**

6 All proposed roadways shall be designed to have a minimal longitudinal slope of 0.30%.

7

8 **Sec. 2-1.5 Roadway Elevations Areas with high water tables**

9 **(a)** The crown of all proposed roadways must be at minimum of 4 feet above mean sea
10 level (NGVD) unless approved by the County Engineer. All proposed roads shall be
11 designed to have a minimum of 2 feet of separation between the seasonal high water
12 table and the bottom of the base coarse.

13 **(b) Development of residential subdivisions in areas with high water tables shall comply**
14 **with the following requirements:**

15 **(1) Borings.** Where the depth of the permanent water table is less than two feet, or
16 is uncertain, the county may require a typical boring for each subdivision lot.
17 Water table depths and elevations determined by the borings shall be certified by
18 a Florida registered professional engineer or geologist and shown on the
19 subdivision lot grading plan.

20 **(2) Engineering report.** No slab-supported or on-grade building shall be constructed
21 on a subdivision lot where the permanent water table is less than two feet below
22 the average grade of the lot except in compliance with the requirements of a
23 special engineering report prepared by a Florida registered professional engineer
24 and submitted with the preliminary plat. The report shall address subsurface
25 conditions and construction methods to ensure the provision of adequate
26 foundations and safe, stable construction of all buildings, driveways and streets in
27 the subdivision. Any construction restrictions determined by the report shall be
28 noted on the lot grading plan of the subdivision construction plans and referenced
29 on the face of the final plat.

30

31 **2-1.6 Street Layout**

32 Where appropriate to the design, proposed streets shall be continuous and in alignment with
33 existing, planned or platted streets with which they are to connect. Future commercial and
34 residential subdivisions along major roads, thoroughfares and arterial streets shall provide
35 access routes for all uses within the subdivision.

36

37 **(a) Connectivity**

38 Proposed streets shall extend to the boundary lines of the tract to be subdivided. If a
39 subdivision or an undeveloped parcel of substantial size (as determined by the County
40 Engineer or its designee) is adjacent to the proposed subdivision, said proposed streets shall
41 connect with streets in the existing, platted, or planned subdivision or parcel. However,
42 nothing herein shall grant to any person or entity other than Escambia County any right of
43 access or right to require the granting of access. However, if the county engineer and the
44 applicant agree that the proposed subdivision should not connect with an adjacent

1 subdivision, said connection will not be required.

2

3 **(b) Large Development Ingress/Egress**

4 In a proposed subdivision or accumulation of subdivisions of 100 lots or more adjacent to an
5 existing or platted subdivision where extension of proposed streets to the boundaries would
6 dead end with no feasible street connections, there shall be at least two entrance streets into
7 a loop street through the proposed subdivision which streets shall be connected to a paved
8 road. For the purpose of this provision a loop street means the primary local road designed to
9 move traffic through the subdivision. The developer may utilize a single ingress/egress point,
10 provided however, that such point provides for separation of traffic entering and exiting the
11 subdivision by means of a boulevard and shall run the entire length of the entrance road
12 between the connecting road and the loop road. In addition, left and right turn lanes must be
13 provided for the connecting road.

14

15 **(c) Dead End Streets**

16 Cul-de-sac or local dead-end street shall not exceed 1,200 feet in length, exclusive of the
17 permanent turning circle at the end of that street; however, the county engineer may
18 recommend approval of a cul-de-sac over 1,200 feet in length to serve odd-shaped parcels of
19 land which cannot be developed in any other reasonable manner or to serve property that
20 would otherwise be denied reasonable access caused by manmade or natural obstacles
21 adjacent to such property.

22

23 **(d) Utilities in road right of ways**

24 No streets or roads under the two-year warranty will be allowed to be open cut, or jack-and
25 bored, unless specifically approved by the county engineer. To accomplish this requirement,
26 common trenching is required whenever possible. If a determination is made that common
27 trenching is not a feasible option, the developer will install conduit or make other appropriate
28 arrangements for the utility not participating in the common trenching and the utility will be
29 required to use the conduit. This shall require planning between the utility and the developer.

30

31 **2-1.7. Traffic control devices.**

32 The developer shall install traffic control devices as specified by the County Engineer. Such
33 devices shall conform to provisions in the Manual on Uniform Traffic Control Devices and
34 FDOT standards.

35

36 **2-2 Access Management**

37 Vehicular access to public roadways shall be accomplished by means of an improved access
38 facility (i.e., driveway, private road, etc.) Unimproved and/or unrestricted access will not be
39 permitted. All driveways and streets shall be designed and constructed pursuant to the
40 design standards in the most recent edition of the "A Policy on Geometric Design of
41 Highways and Streets" by the American Association of State Highway Transportation
42 Officials" and/or "The Manual of Uniform Minimum Standards for Design, Construction and
43 Maintenance for Streets and Highways," and FDOT.

44

45 **2-2.1 Access Location**

46 Unless otherwise approved by the county engineer, in order to reduce turning movements on
47 roadways, new access points to development sites or projects should be as follows:

48

Posted Speed (mph)	Distance Between Access Points (feet)
>45	440
36--45	245
35 or less	125

For parcels which front two or more roadways, access shall be permitted onto the higher class roadway if the driveway location can meet the driveway separation standard shown above.

2-2.2 Pedestrian Access

(a) Commercial Development

For commercial sites with buildings individually or cumulatively 50,000 GSF or greater, pathways through parking lots and across driveways between buildings and out parcels shall be provided for pedestrians. Such pathways shall be separated from vehicle driveways and shall be clearly identified by curbs, pavement markings, planting areas, fences or similar features designed to promote pedestrian safety.

(b) Sidewalks

Sidewalks are to be constructed along the *frontage of a commercial development or subdivision* if any of the following conditions apply:

1. An existing sidewalk abuts the development, or is on one or both sides of an intervening/intersecting street.
2. The need for site specific improvements are identified within an approved Florida/Alabama TPO Bike/Pedestrian Master Plan.

3. When 50% or more of any developable portion of the property is within 2 miles of public school property as measured radially from the school's main front office entrance.

3.4. Commercial properties that fall within the two mile radius may be considered exempt from the required sidewalk construction if the property has an excessive amount (TBD) of roadway frontage and is proposing a minimal amount of additional impervious area (TBD).

Frontage shall be described as the property line that is located closest to the shortest walkable route to the school and possesses at least one main subdivision entrance or the primary driveway into the commercial development.

(c) Bikeways

Class I (separated from the roadway) or II (striped) bikeways shall be constructed along the frontage of a development if any of the following conditions apply:

1. An existing bikeway abuts the development; or

1 2. The need for a bikeway is identified by TPO Bike and Pedestrian Plan.

2
3 **(d) Repair**

4 Existing sidewalks and bikeways damaged during the development of a property shall be
5 repaired or replaced by the owner of such property as directed by the division manager,
6 development services.

7
8 **(e) Connectivity**

9 A separate access connection that routes pedestrians from the sidewalk to the building shall
10 be provided for developments which are expected to attract pedestrian traffic.

11
12 **(f) Density bonuses**

13 Details regarding the provisions for density bonuses for sidewalks and bike paths are
14 provided in LDC Chapter 3 – zoning.

15
16
17 **2-2.3 Traffic control**

18
19 **(a) Traffic control devices**

20 The County Engineer shall require the reasonable placement of traffic control signs,
21 pavement markings, and traffic signals at any roadway or driveway, or within any
22 development, if it is necessary, to provide for the safe and efficient movement of traffic at or
23 prior to the preliminary plat, construction plans or site plan approval, if such device is justified.
24 All traffic control devices shall be designed and installed in accordance with the Manual On
25 Uniform Traffic Control Devices (USDOT, most recent edition) and the Roadway and Traffic
26 Design Standards (FDOT, most recent edition).

27
28 **(b) Traffic signals**

29 If a traffic signal proposed by a developer serves a public/public intersection the installation
30 will be conducted by the owner, the maintenance will be paid for and handled by the County,
31 and the County shall be the responsible party of such signal. If it serves a private/public
32 intersection and has the opportunity for additional users, the signal installation will be
33 conducted by the developer/owner, the maintenance of such signal will be handled by the
34 County; however, the developer/owner will pay for the maintenance through the enactment of
35 a development agreement until additional users construct access, and signal will be the
36 responsibility of the County.

37 If a traffic signal is proposed by a developer or property owner on a private/private
38 intersection, it is a private signal. The signal installation will be conducted by the owner, the
39 maintenance will be paid for and handled by the owner, and the signal will be the
40 responsibility of the owner. The signal shall be justified by a traffic study which demonstrates
41 the warrants, design, and operation of the proposed signal. Such studies shall be provided by
42 the developer for approval by the county engineer or their designee. All construction costs for
43 the installation of a traffic signal, including associated roadway modifications, necessitated by
44 and proposed by a developer or property owner shall be borne by same.

45
46 **(c) Turn restrictions**

47 The County Engineer shall restrict turning movements into and out of any roadway or
48 driveway where it is deemed necessary for the safe and efficient movement of traffic, and the

1 decision is based on sound professional engineering practices. Roadway or driveway
2 connections with restricted turn movements shall be geometrically designed so as to provide
3 access only for the movements permitted.
4

5 **(d) Median openings**

6 The location of additional and relocated median openings shall comply with the standards of
7 FDOT in F.A.C. ch. 14.97, as amended.
8

9 **(e) Turn lanes**

10 Warrants for turn lanes into un-signalized driveways or streets were developed to provide for
11 proper access management and safety. A turn lane analysis shall be performed on a County
12 roadway serving a development that generates 50 vehicle trips or greater during any peak
13 hour. Turn lane design shall be supported by documentation of the estimated volume of
14 traffic using the lane, resulting queue length, and design speed of the roadway.

15 The applicant must develop a trip distribution report in accordance with industry
16 standard guidelines using traffic count data provided by either FDOT, Escambia
17 County, or the applicant that is no more than three years old.

18 Turn Lane Warrant Criteria are as follows:

- 19 1. Using the data obtained from the trip generation/distribution report, the following
20 shall apply:
 - 21 a. **Right Turn lanes.** The developer shall construct a right-turn lane(s) on a
22 County roadway to serve right-turning movements entering a development
23 when the estimated volume of such movement is 30 vehicles or greater during
24 any peak hour.
 - 25 b. **Left Turn lanes.** The developer shall construct a left-turn lane(s) on a County
26 roadway to serve left-turning movements entering a development when the
27 estimated volume of such movement is 30 vehicles or greater during any peak
28 hour.
 - 29 c. **If a right or a left turn lane(s) is not required under section 1, proceed to
30 section 2.**
- 31 2. If the number of turning movements, as determined by the Trip Distribution Report,
32 is 25.5 to 30 vehicles during any peak hour, a certified un-signalized turn lane
33 analysis shall be performed by a licensed Florida Professional Engineer using
34 approved methodologies such as those in NCHRP Report 457, 659 or 193, and the
35 Highway Capacity Manual software.

36
37 **2-2.4 Modification of existing access**

38 **(a) Abandoned access**

39 When an existing driveway or other type of access is abandoned, or not used to serve a
40 redeveloped site, the developer or property owner shall remove all pavement or gravel and
41 restore the road rights-of-way. Restoration shall include but not be limited to, grading, culvert
42 removal and replacement of curbing, sidewalk and stabilization.
43

44 **(b) Additions**

45 Unless the project is de minimis, reconstruction and/or removal of existing access

1 connections to current standards is required when a site is redeveloped or expanded and the
2 number of average daily vehicle trip ends attracted/generated by the new use is increased by
3 50 percent or more of the previous use.
4

5 **(c) Change of use**

6 Alteration of existing access connections by the property owner shall be required by the
7 County Engineer whenever the nature of business conducted at a location changes so as to
8 cause a change in the traffic pattern on a roadway which is reasonably expected to cause
9 undue disruption to traffic or present a safety hazard.
10

11 **2-2.5 Internal site access design**

12 **(a) Parking area setbacks**

13 Parking shall be set back from the property line at driveways so as to not interfere with safe
14 ingress/egress of traffic. The set back distance should be determined according to the
15 estimated speed and volume of traffic entering a driveway and shall meet all the visual
16 clearance requirements.
17

18 **(b) Drive-through stacking**

19 Drive-in and drive-through developments shall provide adequate queue storage capacity
20 based on the peak hour storage requirements of the project which is subject to the review
21 and approval by the County Engineer.
22

23
24
25
26 **2-2.6 Commercial traffic in residential areas**
27

28 No permit, development order, or other approval shall be issued for any proposed
29 commercial use which requests primary, secondary, or limited access onto a local street if
30 that local street is fronted by more than 50 percent residential zoning in the following districts:
31 LDR, MDR, LDR-PK, MDR-PK, measured in linear feet along the center line of the local
32 street impacted by the proposed development. This provision will not apply when its strict
33 application would deny all access to a parcel that is zoned for any commercial use.
34

35 **Article 3 – Parking**

36 **3-1 Parking and Loading**
37

38 **3-1.1 Stall and aisle design**

39 **(a) Stall Dimensions**

40 Standard parking stalls shall be 9 feet wide by 18 feet long for all but parallel parking.
41 Parallel stalls shall be 9 feet wide by 23 feet long.

42 **(b) Stall Angles**

43 The angles of non-parallel parking stalls in relation to the alignment of the accessing drive
44 aisle are restricted to 90, 60 or 45 degrees.

1 **(c) Stall Accessibility**

2 Each parking stall shall be accessible from an aisle or driveway and designed so that
3 vehicles can enter and exit the stall without backing into the travel way of any street.

4 **(d) Aisles Dimensions**

5 1. Standard one-way drive aisles shall be 24 feet if accessing 90 degree parking
6 stalls, 16 feet wide if accessing 60 degree stalls, and 12 feet wide if accessing
7 45 degree or parallel stalls, or if accessing no stalls.

8 2. Standard two-way drive aisles shall be 24 feet wide if accessing 90 degree
9 parking stalls, and 20 feet wide if accessing 60 degree, 45 degree or parallel
10 stalls, or if accessing no stalls.

11 **(e) Turnarounds**

12 All parking areas containing three or more parking spaces shall include a turnaround that is
13 designed and located so that vehicles can enter and exit the parking area without backing
14 into a public right-of-way.

15 **(f) Encroachment**

16 Landscape areas and pedestrian pathways shall be protected from vehicle encroachment
17 using wheel stops, raised curbing, bollards or similar fixed barriers such vehicles overhang no
18 more than two feet into landscape areas or pedestrian pathways.

19 **(g) Delineation and traffic control**

20 All paved parking spaces shall be striped in white and all driving aisles clearly delineated.
21 Spaces for motorcycles, bicycles and handicap parking shall be clearly marked. Parking lot
22 traffic control signage and marking shall conform to the latest editions of the *Manual on*
23 *Uniform Traffic Control Devices*, U.S. Department of Transportation, and the *Florida*
24 *Accessibility Code for Building Construction*.

25 **(h) Pedestrian entrances**

26 No door or other pedestrian entrance shall open directly upon any driveway or access aisle
27 unless the entrance is at least three feet from the driveway or access aisle.

28

29 **(i) Surface materials**

30 1. Except as allowed for excess parking or limited uses, the stalls, drive aisles and
31 accesses of all parking required by this article shall be finished with an all-
32 weather surface capable of withstanding ordinary use under normal weather
33 conditions without substantial deterioration. For these purposes, all-weather
34 surfaces are limited to concrete and asphalt pavement, recycled asphalt, gravel,
35 crushed stone or shell, and paving stones. Areas of higher intensity use, such
36 as site accesses or heavy truck routes, may be limited by the county to paved
37 surfaces.

38 2. All non-handicap required parking for places of worship, parks and
39 campgrounds, or parking in excess of the quantities required by this article, may
40 be finished in stable grass, provided tree protection is established for any
41 preserved trees within the parking area and the spaces are delineated in a
42 manner acceptable to the county.

43 **(j) Drive-through stacking**

1 Any development with drive-through facilities shall provide adequate vehicle queuing capacity
2 based on the peak hour requirements of the development. Where inadequate queuing
3 capacity causes a recurring traffic hazard or nuisance off-site, the owner will be responsible
4 for increasing the queuing capacity or decreasing the need for queuing.
5

6 **3-1.2 Parking Demand**

7

8 **(a) Quantity**

9 The number of off-street parking spaces required for development shall be determined by
10 land use according to the parking demand ratios listed below. The ratios may be exceeded or
11 reduced by up to 10 percent without further justification.
12

13 **(b) Computation**

14 In computing the number of required parking spaces, any interpretations made regarding the
15 independent variables should be in favor of the most reasonable assumptions regarding their
16 associated parking demand and according to the following conditions:

- 17 1. Square footage. The independent variable of square footage is gross floor
18 area, unless otherwise noted.
- 19 2. Mixed uses - In the case of mixed or multiple uses, the parking shall be equal to
20 the sum of the several uses computed separately, unless otherwise noted.

21 **(c) Other quantities**

22 The required number of parking spaces may be increased more than 10 percent without the
23 granting of a variance only if additional landscape within the parking lot is provided as
24 prescribed in Article 7. The required number of spaces may be reduced more than 10
25 percent if sufficient documentation supporting the reduced parking demand is provided to the
26 county. Any parking studies used shall document the source of data from which the
27 alternative quantities were developed, demonstrate sound methodology and engineering
28 principles, and be acceptable to the Planning Official. Without such documentation the
29 parking requirements of other jurisdictions are not considered studies. All approved
30 reductions shall include the condition that where inadequate on-site parking causes a
31 recurring traffic hazard or off-site nuisance, the owner will be responsible for increasing the
32 number of parking spaces or decreasing the need for parking.

33 **(d) Uses not listed**

34 Where land uses do not correspond to any categories listed in this article the Planning Official
35 shall alternatively confirm the sufficiency of parking facilities proposed. For any such use the
36 applicant shall estimate the number of parking spaces required to satisfy the projected
37 demand and provide adequate information from which the demand was estimated, including
38 the following as applicable:

- 39 1. Type of use(s).
- 40 2. Estimated total number of vehicle trips generated during peak conditions and
41 parking duration per trip (turnover rate).
- 42 3. Number of employees.
- 43 4. Building design capacity.

- 1 5. Square feet of use areas.
 2 6. Hours of operation.
 3

Use or activity	Required number of parking spaces
Residential household living	
Single-family dwelling, including townhouse and manufactured (mobile) home	2 per dwelling unit.
Two-family dwelling	2 per dwelling unit
Multi-family dwelling	1.5 per dwelling unit 2 per dwelling unit on Pensacola Beach
Residential group living	
Assisted living facility	0.4 per unit
Dormitory, fraternity or sorority house	0.5 per bed
Nursing home or other skilled nursing facility	0.5 per bed or 1 per 1000 sq. ft.
Retirement or senior adult housing	1 per dwelling unit
Retail sales, excluding vehicles	
Book superstore	1 per 1000 sq. ft
Convenience store (with or without fuel sales)	3 per 1000 sq. ft. 8 per 1000 sq. ft. on Pensacola Beach
Carpet store	2 per 1000 sq. ft.
Food store, bakery, butcher	4 per 1000 sq. ft.
Furniture store	1 per 1000 sq. ft.
Pharmacy or drugstore: without drive-through with drive-through	3 per 1000 sq. ft. 2.5 per 1000 sq. ft.
Shopping center	3 per 1000 sq. ft.
Retail sales not otherwise listed	3 per 1000 sq. ft.
Retail services, excluding vehicles	
Barber or beauty shop	2 per chair
Bed and breakfast inn	1 per guest room + 2
Boarding and rooming house	1 per guest room + 2
Child care center or adult day care	1 per 6 persons of licensed capacity
Hotel or motel	1 per guest room, or 1 per bedroom if suites, + 50% for restaurants, meeting rooms & other associated uses.
Medical clinic or office	5 per 1000 sq. ft.
Personal service establishment not otherwise listed	2.5 per 1000 sq. ft.
Professional service office	3.5 per 1000 sq. ft.
Service to buildings and dwellings (pest control, janitorial, etc.)	1 per 1000 sq. ft.

Use or activity	Required number of parking spaces
Restaurant: Fast food with drive-through All other restaurants	1 per 2.5 seats (including outdoor) or 10 per 1000 sq. ft. 1 per 2 seats (including outdoor) or 15 per 1000 sq. ft.
Vehicle sales and services	
Rental of automobiles, trucks, utility trailers and/or recreational vehicles	1 per 1000 sq. ft.
Sales of parts, accessories and tires	4 per 1000 sq. ft.
Sales of new and used motor vehicles and boats	1 per 400 sq. ft. of sales and service area
Service and repair of motor vehicles	1 per 400 sq. ft., including service bays
Public and civic uses	
Clubs, civic or fraternal	1 per 3 persons
Correctional facility	1 per employee, largest shift
Educational facility: Elementary & middle school (K-8) High school (9-12)	1 per 5 students (capacity) 1 per 10 students (capacity) + 1 per classroom
Emergency service facility	1 per employee/volunteer on normal shift + 5 per 1000 sq. ft. office area
Funeral home	1 per 4 seat in assembly area + 1 per employee
Hospital	2.5 per 1000 sq. ft. or 1 per employee
Library	2.5 per 1000 sq. ft.
Museum	1.5 per 1000 sq. ft.
Place of worship	1 per 4 seats or 1 per 35 sq. ft. in principal assembly area if no fixed seats
Public utility structure	1 per employee or service person, as applicable
Recreation and entertainment	
Arcade amusement center	1 per game table, video game, or other amusement device
Bar or nightclub	1 per 2 seats
Bowling alley	4 per lane
Golf course	6 per hole + 50% for restaurants & other associated uses.
Health, fitness or athletic club	5 per 1000 sq. ft.
Marina, public	1 per boat berth or slip + spaces for associated uses
Soccer complex	50 per field
Tennis court	4 per court
Theater	1 per 4 seats
Industrial and related uses	

Use or activity	Required number of parking spaces
Laboratory	1 per 1000 sq. ft.
Manufacturing and light industrial	1 per 1000 sq. ft. or 1 per employee
Salvage yard	1 per employee
Warehousing, distribution or wholesale	0.5 per 1000 sq. ft. or 1 per employee
Other uses	
Mini-warehouse or self-storage	1.5 per 100 storage units + 2
Public assembly structure not otherwise listed	1 per 5 seats or 1 per 35 sq. ft. of assembly area if no fixed seats
Veterinary clinic or animal hospital	4 per 1000 sq. ft. or 2 per employee

1
2
3
4
5
6
7
8
9
10
11
12
13
14
15
16
17
18
19
20
21
22
23
24
25
26
27
28
29
30
31
32

Sec. 3-1.3 Off-site and joint use parking

(a) Off-site parking. If the off-street parking required by the LDC for a specific use cannot be fully accommodated on the site of the use, the remaining required parking may be provided off-site in compliance with the following conditions:

(1) Pedestrian paths. Where the off-site parking relies on a pedestrian pathway to access the site of the use, the parking shall be within 300 feet of the use as measured along a pedestrian pathway that complies with all of the following:

- a. Accessibility.** For any part of the pathway within a street right-of-way, accessibility shall be as prescribed by the latest edition of the *Public Rights-of-Way Accessibility Guidelines*, United States Access Board. All other parts of the pathway shall be as prescribed by the *Florida Accessibility Code for Building Construction*.
- b. Sidewalks.** For any part of the pathway within a street right-of-way, the pathway shall be a concrete sidewalk along the shoulder of the roadway, five feet wide if curb and gutter is present or six feet wide if there is no curb and gutter, and otherwise complying with county construction standards.
- c. Street crossings.** Any pathway that crosses a street shall do so at a marked pedestrian crossing, and where the posted speed limit of the street is greater than 35 miles per hour the marked crossing shall be at a signalized intersection.
- d. Easements.** If any part of the intended pedestrian route is through one or more private parcels, the developer shall secure an easement allowing pedestrians to legally traverse the route.
- e. Improvements.** If the required pathway is not present or is in substandard condition, including applicable street crossing features, the developer shall be responsible for its construction or augmentation. Additional requirements for improvements may be imposed on the developer at the discretion of the County Engineer based on the existing condition of the street or shoulder to be traversed. Required improvements may include striping, signage, lighting, grading, etc.

(2) Mid-block crossings. In general, the county does not support mid-block crossings on streets with average daily trips greater than 600 or with speed limits greater than 35

1 miles per hour. However, marked mid-block crossings may be constructed by a
2 developer if supported by sound engineering practices and approved by the County
3 Engineer.

4 **(3) Continuing obligation.** The conditions required by this section for off-site parking
5 shall remain in effect for the duration of the need of such parking to comply with LDC
6 requirements for off-street parking.

7 **(b) Joint use parking.** The Planning Official may authorize a reduction in the total number of
8 required parking spaces for two or more uses jointly providing off-street parking when
9 their respective parking needs do not normally overlap, but such a reduction shall comply
10 with the following conditions:

11 **(1)** The developer submits sufficient data to demonstrate that the demand for parking at
12 the respective uses does not normally overlap.

13 **(2)** The off-street parking to be shared complies with all other applicable provisions of the
14 LDC.

15 **(3)** The developer submits a legal agreement, approved by the County Attorney and
16 signed by all property owners involved, guaranteeing the joint use of the parking
17 spaces for as long as the uses requiring parking are in existence, or until the required
18 parking is provided elsewhere in compliance with the provisions of the LDC. The
19 agreement shall include provisions for the maintenance of the parking facility and
20 covenants running with the lands of both the dominant and subordinate parcels or
21 uses.
22

23 **Sec. 3-1.4 Loading and unloading**

24 Development shall provide and maintain sufficient off-street loading and unloading areas as
25 prescribed in this section whenever normal operations requires that goods, merchandise, or
26 equipment be routinely delivered to or shipped from the development.

27 No area allocated to loading and unloading areas may be used to satisfy the area
28 requirements for off-street parking, nor shall any portion of any off-street parking are be used
29 to satisfy the area requirements for loading and unloading facilities.

30 **(a) Location and design**

31 Loading and unloading areas shall be located and designed to meet the following
32 standards:
33

34 1. Maneuvering

35 Vehicles intended to use the areas can maneuver safely and conveniently to
36 and from a public right-of-way and access them without backing into or from a
37 street right-of-way with a posted speed limit of 35 miles per hour or greater.

38 2. Obstructing

39 Loading and unloading operations can be completed without obstructing or
40 interfering with any public right-of-way.

41 **(b) Number of spaces**

42 The following table indicates the minimum number of loading/unloading spaces required to
43 accommodate delivery and shipment, not including the collection of solid waste:

Building gross floor area in square feet	Spaces
10,000 - 19,999	1
20,000 - 79,999	2
80,000 - 127,999	3
128,000 - 191,999	4
192,000 - 255,999	5
256,000 - 319,999	6
320,000 - 391,999	7
each additional 72,000 or fraction	+1

1 **(c) Space dimensions**

2 The minimum dimensions of an individual loading/unloading space shall be 12 feet by 55 feet
3 with an overhead clearance of 14 feet above grade.

4 **(d) Reasonable extent**

5 Whenever there is a lot with one or more structures on it constructed before the effective date
6 of the LDC and there is a change in use proposed that does not involve any enlargement of a
7 structure on the lot, if the loading area requirements of this section cannot be satisfied for the
8 new use because there is insufficient area available on the lot that can practicably be used
9 for loading and unloading, then the use need only comply with this section to the extent
10 reasonably possible as determined by the County Engineer.

11 **(e) Solid waste**

12 Refuse and waste removal areas shall be buffered and/or screened from adjacent properties
13 and public ways by appropriate fences, wall or hedges.

14

DSM Professional Advisory Committee

3. B.

Meeting Date: 11/07/2016

Submitted By: Allyson Cain, Development
Services

Information

Recommendation:

Low Impact Development (New)

Attachments

Low Impact Development



Pervious parking lot at Central Office Complex



ESCAMBIA COUNTY LOW IMPACT DESIGN BMP MANUAL



Bioretention area in pervious parking lot
at Central Office Complex

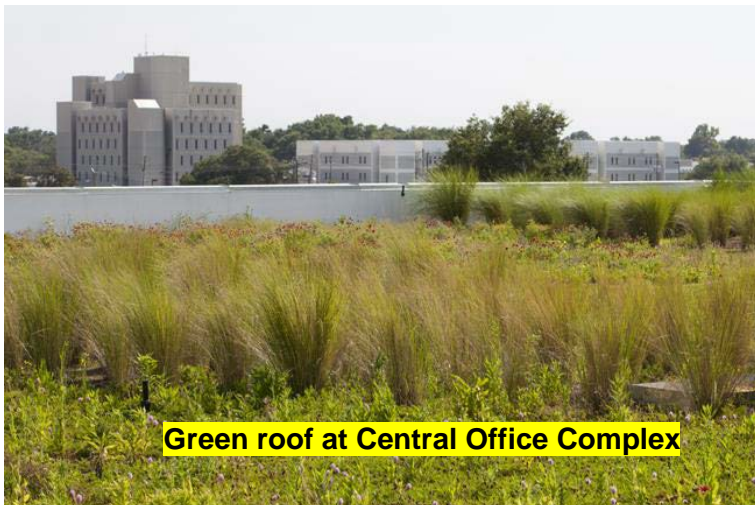

Green roof at Central Office Complex

Page intended to be blank

List of Figures.....ix
List of Tables x
ACKNOWLEDGEMENTSXI
EXECUTIVE SUMMARYXII
CHAPTER 1 - INTRODUCTION 1
1.1. Purpose and Intended Users..... 1
1.2. Organization of the Manual 1
 1.2.1. Chapter 1: Introduction 1
 1.2.2. Chapter 2: Escambia County Context 1
 1.2.3. Chapter 3: Improved Site Design: Evaluating and Master Planning a Site 1
 1.2.4. Chapter 4: Evaluating Stormwater Treatment Effectiveness 2
 1.2.5. Chapter 5: LID BMPs for Escambia County 2
 1.2.6. Chapter 6: Regulatory Framework for LID BMPs 2
 1.2.7. Appendices 3
1.3. List of Acronyms..... 3
1.4. Terminology and Definitions..... 3
CHAPTER 2 – LOCAL CONTEXT..... 9
2.1. Introduction..... 9
2.2. Local Hydrologic and Water Resource Context..... 9
 2.2.1. Geomorphology 9
 2.2.2. Rainfall Characteristics 9
 2.2.3. Hydrologic Soil Properties.....10
 2.3.5. Escambia County Surface Waters and Watersheds.....12
 2.3.6. Discharges to Escambia County Water Bodies14
 2.3.7. References.....15
**CHAPTER 3 – IMPROVED SITE DESIGN: EVALUATING AND MASTER PLANNING
A SITE..... 16**
3.1. Introduction.....16
3.2. Changes in Stormwater Characteristics from Urban Development16
 3.2.1. Changes in Urban Hydrology16
 3.2.2. Stormwater Pollutants and Removal Processes.....17
3.3. Goals of Stormwater Management20
 3.3.1. General goals of stormwater management20
 3.3.2. Escambia County Comprehensive Plan - Stormwater Management Goals21
3.4. Introduction to Stormwater Management.....21
3.5. Introduction to Low Impact Design22
 3.5.1. What is “Low Impact Development” or “Low Impact Design” (LID)22
 3.5.2. Advantages of LID24
3.6. Site Planning and Design26
3.7. References Cited.....31
CHAPTER 4 – EVALUATING STORMWATER TREATMENT EFFECTIVENESS 33

- 4.1. Introduction.....33**
- 4.2. Stormwater Treatment Processes33**
- 4.3. Stormwater Treatment Performance Standards35**
 - 4.3.1. Projects within Watersheds of Impaired Water Bodies or Water Bodies with Adopted Total Maximum Daily Loads (TMDLs35
 - 4.3.2. Presumptive Criteria36
 - 4.3.3. Criteria Flexibility and Alternative Designs36
- 4.4. Calculating Stormwater Pollutant Loading.....37**
 - 4.4.1. Calculation of Pre-Development and Post-Development Hydrology37
 - 4.4.2. Calculation of Pre-Development (Current) Stormwater Pollutant Loading40
 - 4.4.3. Calculation of Post-Development Stormwater Pollutant Loading.....41
- 4.5. Designing the BMP Treatment Train to Meet Required Load Reductions41**
- 4.6. Computational Aids.....42**
- 4.7. References42**
- CHAPTER 5 – ESCAMBIA COUNTY LOW IMPACT DESIGN BMPS..... 44**
- 5.0. Best Management Practices44**
 - 5.0.1 Introduction to BMPs.....44
 - 5.0.2 Integrating Landscaping and Low Impact Design BMPs47
- 5.1. Site Planning BMPs47**
 - SP1. Inventory Site Assets: Hydrology48
 - SP2. Inventory Site Assets: Topography49
 - SP3. Inventory Site Assets: Soils.....49
 - SP4. Inventory Site Assets: Vegetation49
 - SP5. Protect Surface Waters and Wetlands50
 - SP6. Preserve Open Space.....51
 - SP7. Natural Area Conservation - Retain Tree Canopy and Natural Landscaping.....52
 - SP8. Cluster Design and Maximize Gross Density53
 - SP9. Minimize Building Footprint53
 - SP10. Minimize Total Impervious Surface Area.....54
 - SP11. Minimize Directly-Connected Impervious Area (DCIA)55
 - SP12. Curb Elimination and Curb Cuts.....56
- 5.2. Source Control BMPs58**
 - SC1. Retain Natural Landscape Depressions58
 - SC2. Use Selective Site Clearing and Grading58
 - SC3. Minimize Soil Disturbance and Compaction58
 - SC4. Build with the Landscape Slope59
 - SC5. Retain Native Landscapes at the Lot Level59
 - SC6. Florida-Friendly Landscaping and Fertilizers.....60
 - SC7. Rainfall Interceptor Trees.....62
 - SC8. Install Efficient Irrigation Systems64
 - SC9. Use Non-Potable Water Supply for Irrigation.....64
 - SC10. Community and Homeowner Education65
- 5.3. Structural Stormwater BMPs.....66**
- 5.3. Retention Basin Design Criteria67**

- 5.3.1. Description.....67
- 5.3.2. Required Treatment Level and Associated Treatment Volume68
- 5.3.3. Calculating Load Reduction Efficiency for a Given Retention Volume69
- 5.3.4. Design Criteria69
- 5.3.5. Required Site Information69
- 5.3.6. Retention Basin Construction.....69
- 5.3.7. Inspections, Operation and Maintenance70
- 5.4. Exfiltration Trench Design Criteria72**
 - 5.4.1. Description.....72
 - 5.4.2. Required Level of Treatment and Associated Treatment Volume.....73
 - 5.4.3. Calculating Load Reduction Efficiency for a Given Retention Volume73
 - 5.4.4. Design and Performance Criteria74
 - 5.4.5. Required Site Information75
 - 5.4.6. Construction requirements77
 - 5.4.7. Inspections, Operation and Maintenance78
- 5.5. Underground Storage and Retention Systems Design Criteria79**
 - 5.5.1. Description.....79
 - 5.5.2. Required Treatment Volume80
 - 5.5.3. Calculating Load Reduction Efficiency for a Given Retention Volume80
 - 5.5.4. Design Criteria80
 - 5.5.5. Required Site Information81
 - 5.5.6. Construction requirements81
 - 5.5.7. Inspections, Operation and Maintenance82
- 5.6. Rain Gardens (Bioretention Systems).....84**
 - 5.6.1. Description.....84
 - 5.6.2. Required Treatment Volume85
 - 5.6.3. Calculating Load Reduction Efficiency for a Given Retention Volume85
 - 5.6.4. Design Criteria85
 - 5.6.5. Construction of the Rain Garden87
 - 5.6.6. Inspection and Maintenance88
- 5.7. Vegetated Swales.....89**
 - 5.7.1. Description.....89
 - 5.7.2. Swales with Swale Blocks or Raised Driveway Culverts (Linear Retention)90
 - 5.7.3. Swales without Swale Blocks or Raised Driveway Culverts (Conveyance Swales)
91
 - 5.7.4. Required Treatment Volume for Conveyance Swales91
 - 5.7.5. Calculating Load Reduction Efficiency for a Given Retention Volume91
 - 5.7.6. Calculating the Swale Length for Swales without Blocks.....92
 - 5.7.7. Design Criteria for Swales.....92
 - 5.7.8. Soil Requirements and Testing Requirements93
 - 5.7.9. Construction and Stabilization Requirements.....93
 - 5.7.10. Inspections, Operation and Maintenance Requirements93
- 5.8. Vegetated Natural Buffers95**
 - 5.8.1. Description.....95

- 5.8.2. Required Treatment Volume96
- 5.8.3. Calculating Load Reduction Efficiency for a Given Retention Volume97
- 5.8.4. Design Criteria97
- 5.8.5. Required Site Information98
- 5.8.6. Construction Requirements.....98
- 5.8.7. Inspections, Operation and Maintenance98
- 5.9. Pervious Pavement Systems100**
- 5.9.1. Description.....100
- 5.9.2. Applicability.....101
- 5.9.3. Required Treatment Volume102
- 5.9.4. Calculating Load Reduction Efficiency for a Given Retention Volume102
- 5.9.5. Design Criteria102
- 5.9.6. Required Site Information105
- 5.9.7. Construction requirements105
- 5.9.8. Inspection, Operation and Maintenance.....106
- 5.9.10. Pervious Pavement Examples in Escambia County116
- 5.10. Greenroof with Cistern Systems119**
- 5.10.1. Description119
- 5.10.2. Required Treatment Volume120
- 5.10.3. Calculating Load Reduction Efficiency for a Given Retention Volume120
- 5.10.4. Classification of Greenroof Surfaces121
- 5.10.5. Design Criteria122
- 5.10.6. Design Criteria for Management of the Filtrate124
- 5.10.7. Construction requirements124
- 5.10.8. Inspections, Operation and Maintenance125
- 5.10.9. Greenroof with Cistern - Harvesting Design Curves and Equations.....126
- 5.11. Rainwater Harvesting.....128**
- 5.11.1. Description128
- 5.11.2. Applicability and Siting Considerations.....130
- 5.11.3. Required Treatment Volume131
- 5.11.4. Design Criteria131
- 5.11.5. Construction Requirements134
- 5.11.6. Inspection, Operation, and Maintenance134
- 5.12. Stormwater Harvesting Systems.....136**
- 5.12.1. Description136
- 5.12.2. Treatment required.....137
- 5.12.3. Equivalent Impervious Area.....137
- 5.12.4. Design Criteria139
- 5.12.5. Construction requirements141
- 5.12.6. Inspections, Operation and Maintenance141
- 5.12.7. Rate-Efficiency-Volume (REV) Curves142
- 5.12.8. References.....143
- 5.13. Up-Flow Filter Systems.....144**
- 5.13.1. Description144

- 5.13.2. Treatment required.....145
- 5.13.3. Expected Load Reduction146
- 5.13.4. Design Criteria147
- 5.13.5. Construction considerations148
- 5.13.6. Inspections, Operation and Maintenance149
- 5.13.7. References.....150
- 5.14. Managed Aquatic Plant System (MAPS) Design Criteria.....152**
 - 5.14.1. Description152
 - 5.14.2. Nutrient Removal Effectiveness and Credits.....152
 - 5.14.3. Littoral Zone Design Criteria.....153
 - 5.14.4. Floating Wetland Islands or Mats158
- 5.15. Biofiltration Systems with Biosorption Activated Media (BAM).....160**
 - 5.15.1. Description160
 - 5.15.2. Biosorption Activated Media (BAM)161
 - 5.15.3. Applicability162
 - 5.15.4. Design Considerations and Requirements.....166
 - 5.15.5. Biofiltration Design Procedure171
 - 5.15.6. Biofiltration Design Example.....172
 - 5.15.7. Operation and Maintenance172
 - 5.15.8. Planter Box Biofiltration Systems.....173
 - 5.15.9. Tree Box Filter Systems175
- CHAPTER 6. REGULATORY FRAMEWORK FOR LID BMPS 178**
 - 6.1. Introduction.....178**
 - 6.2. Institutional and Technical Framework for Florida’s Stormwater Treatment Rule
178**
 - 6.3. Compatibility with State Environmental Resource Permitting (ERP) Rules180**
 - 6.4. Presumptive Criteria and LID BMP Design Criteria180**
 - 6.4.1. Rain Garden (Bioretention Systems).....181
 - 6.4.2. Swales181
 - 6.4.3. Vegetated Natural Buffers.....181
 - 6.4.4. Pervious Pavement.....182
 - 6.4.5. Green Roofs with Cisterns182
 - 6.4.6. Rainwater Harvesting Systems182
 - 6.4.7. Stormwater Harvesting182
 - 6.4.8. Up-Flow Filter Systems.....182
 - 6.4.9. Managed Aquatic Plant Systems (MAPS)182
 - 6.4.10. Biofiltration Systems with BAM.....183
 - 6.4.11. Source Control and Site Planning BMPs.....183
 - 6.5. References183**
- APPENDIX A. RAINFALL ZONE 1 RETENTION BMP TREATMENT VOLUMES AND
AVERAGE ANNUAL POLLUTANT LOAD REDUCTIONS. 185**
 - Table A1-1. Dry Retention Depths for an Annual Load Reduction Efficiency of 80
Percent in Zone 1.....186**

Table A2-1. Dry Retention BMP Mean Annual Pollutant Load Reduction for Various Stormwater Treatment Volumes as a Function of DCIA and non-DCIA Curve Number for Meteorological Zone 1.....187

APPENDIX B. METHODOLOGIES..... 195

B.1. Methodologies, Recovery Analysis, and Soil Testing for Retention Systems....196

B.1.1. Description.....196
 B.1.2. Required Treatment Volume (RTV).....196
 B.1.3. Recovery Time of the RTV.....197
 B.1.4. Infiltration Processes.....197
 B.1.5. Accepted Methodologies for Determining Retention BMP Recovery198
 B.1.6. Requirements, Guidance and Recommendations for Manual Computations or Computer Simulations.....199
 B.1.7. Requirements, Guidance and Recommendations for BMP Soil Testing.....202
 B.1.8. Sediment Sump Design Example.....206

APPENDIX C: ESCAMBIA COUNTY SURFACE WATERS 208

HOW TO USE THIS DOCUMENT

Underlined [blue](#) words include terms that are defined in Section 1.4, Terminology, are bookmarks to other sections within the Manual, or are links to web pages that provide information. If you click on these words, you will be taken to either the part of the document where the term is defined or explained, or you will be taken to an external web site.

In Word, after clicking on the blue word, to get back to your original part of the document, you must install the “BACK” button for Word. To install the “BACK” button and “FORWARD” button, complete these steps:

For Word 2016, Click on File, then on Options. Click on “Customize Ribbon”

For earlier versions of Word, click the Microsoft office button in the top left corner of your Word window.

Click on “Word Options” at the bottom of the menu.

Click on “Customize” from the left pane.

In “Choose commands from” drop-down menu, select “All Commands”.

From the list of commands find “Back” and click “Add”

Similarly, find “Forward” and click “Add”

In PDF, after clicking on the blue word, to get back to your original part of the document, follow these steps:

- Click on “View” at the top of the screen
- Click on “Page Navigation”
- Click on “Previous View”

List of Figures

Figure 2.1. Escambia County Hydrologic Soil Groups Distribution	11
Figure 2.2. Escambia County Water Bodies and Wetlands	12
Figure 2.3. Escambia County Watersheds.....	13
Figure 3.1. Stormwater flow changes associated with urbanization.....	16
Figure 3.2. How Impervious Cover Affects the Water Cycle.....	17
Figure 3.3. The Nitrogen Cycle transforms nitrogen into nitrogen gas.....	20
Figure 3.4. Environmental Resources Assessment Checklist.....	29
Figure 3.5. Stormwater LID BMPS at the Lot Scale	30
Figure 3.6. Stormwater LIDs at the Lot Scale (Medera Model Home)	30
Figure 4.1. Stormwater Treatment Tradeoff – Particle Size vs. Hydraulic Loading.....	34
Figure 4.2. Annual Rainfall Isopleths in Escambia County.....	38
Figure 5.1. Removal Efficiency of Total Phosphorus in Wet Detention Ponds as a Function of Average Annual Residence Time	45
Figure 5.2. Removal Efficiency of Total Nitrogen in Wet Detention Ponds as a Function of Average Annual Residence Time	45
Figure 5.3.1. Typical Cross-section of “Dry” Retention Basin	68
Figure 5.4.1. Cross-section of a “DRY” Exfiltration Trench (N.T.S.)	73
Figure 5.4.2. Typical Exfiltration Trench Sumps and Dead End Details.....	75
Figure 5.4.3. Detail for Exfiltration Trench Trash Baffle.....	76
Figure 5.4.4. Generic Detail for a Typical Exfiltration Trench Trash Tee.....	77
Figure 5.5.1. Generic Underground Retention System	80
Figure 5.6.1. Typical Cross-Section of a Rain Garden	85
Figure 5.6.2. Schematic and Photo of Rain Garden.....	87
Figure 5.7.1. Typical Cross-section of a Conveyance Swale without Swale Blocks	90
Figure 5.8.1. Plan View Schematic of Typical Vegetative Natural Buffer	96
Figure 5.9.1. Typical Pervious Pavement Cross Section	101
Figure 5.9.2. Pervious Pavement System Cross Section #1	108
Figure 5.9.3. Pervious Pavement System Cross Section #2	109
Figure 5.9.4. Typical Pervious Pavement System Cross Section #3	110
Figure 5.9.5. Plan View of ERIK In-Situ Infiltrometer - (Embedded Ring Infiltration Kit)	111
Figure 5.9.6. ERIK Measuring Tube.....	112
Figure 5.9.7. Pervious Pavement Site Plan	113
Figure 5.9.8. Pervious Pavement Site Plan	114
Figure 5.9.9. Pervious Pavement Site Plan	115
Figure 5.10.1a. Extensive Greenroof Section (Usually Passive Function)	121
Figure 5.10.1b. Intensive Greenroof Section (Usually Active Function)	121
Figure 5.10.2. Greenroof With Cistern Harvesting Design Curve for Niceville, Florida Area.....	126
Figure 5.10.3. Greenroof With Cistern Harvesting Equation for Niceville, Florida Area	127
Figure 5.11.1. Rate Efficiency Volume (REV) Curve for a Rainwater Harvesting System in Escambia County with Constant Daily Demand.....	131
Figure 5.12.1 Typical Cross Section of a Stormwater Harvesting System.....	138
Figure 5.12.2. Schematic for a Typical Stormwater Harvesting Pond.....	139
Figure 5.12.3. Schematic for a Two Typical Stormwater Harvesting Withdrawal Systems.....	140

Figure 5.12.4. REV Curve for Escambia County 143

Figure 5.13.1a. Off-line Up-Flow Filter Schematic 145

Figure 5.13.1b. Top View of Diversion Box to Off-Line Filter 146

Figure 5.13.2. Typical Schematic of an Up-flow Filter after Wet Detention with Water Flow Direction Shown . 149

Figure 5.15.1. Plan View Illustrating a Biofiltration System 163

Figure 5.15.2. Cross Section View of a Biofiltration System..... 163

Figure 5.15.3. Example Cross Section View for Nitrate Removal with Overflow 164

Figure 5.15.4. Example Stormwater Planter Box Biofiltration System 164

Figure 5.15.5. Example Stormwater Infiltration Planter Box Biofiltration System 165

Figure 5.15.6. Stormwater Tree Box Filter System 165

Figure 5.15.7. Example Average Annual Runoff Capture Efficiency of a Biofiltration System in Escambia County
for Specific Condition 170

Figure A.1.1. Ground Water Mounding Beneath a Retention System 198

List of Tables

Table 2.1. Characteristics of NRCS Hydrologic Soil Groups Classifications 12

Table 3.1. Functional Aspects and Timing of LID BMPs..... 31

Table 4.1. Basic Mechanisms of Stormwater Treatment 34

Table 4.2. Example Land Use Categories Matrix to Calculate Loadings..... 37

Table 4.3. Annual Runoff Coefficients (C Values) as a Function of DCIA Percentage and Non-DCIA Curve Number
(CN) 39

Table 5.1. Stormwater BMP Strategies Checklist..... 46

Table 5.10.1. Plants that have been successfully used on greenroofs in Florida 123

Table 5.13.1. Filter Media and Removal Effectiveness. 148

Table 5.14.1. Nutrient Removal Credits for MAPS..... 153

Table 5.14.2. Native Plant Species Suitable for Littoral Zone Plantings or Adjacent to Wet Detention Ponds ... 154

Table B.1.1. Accepted Methodologies for Retention BMP Recovery 198

This Manual is available for download from:
<http://www.myescambia/LID>

The presentations from the LID Workshops held on August 24-25, 2016 along with a video of the workshop also are available at the above web site.

If a hardcopy of this document is needed, please try to save paper and print this document double-sided.

ACKNOWLEDGEMENTS

The developers of this Manual gratefully acknowledge the vision and work of the local governments that pioneered development of Low Impact Development Manuals and the contributions of all those who assisted with those Manuals. Significant portions of the Escambia County Low Impact Development Manual incorporate parts of the following documents:

- Draft Alachua County Low Impact Development (LID) Design Manual, September 2011
- [Sarasota County Low Impact Development Guidance Document \(May 2015\)](#)
- [Pinellas County Stormwater Management Manual](#) (2016)
- [Draft Alachua County Stormwater Treatment Manual](#) (2016)
- [Draft Florida Department of Environmental Protection and Water Management Districts Environmental Resource Permit Stormwater Quality Applicant's Handbook](#) (March 2010)

Note that this Applicant's Handbook was not adopted by the agencies.

Design criteria for many of the Low Impact Development BMPs in this Manual have been updated from the above documents based on results from monitoring and effectiveness projects completed since 2010. Many of the LID BMP research documents can be downloaded from:

- <http://www.dep.state.fl.us/water/nonpoint/pubs.htm> - [Urban Stormwater BMP Research Reports](#)
- <https://stormwater.ucf.edu/>
- <http://www.dot.state.fl.us/> - search for "stormwater research"

We appreciate the review and comments provided by Escambia County and DEP staff on the draft Manual.

This Manual, and the LID Workshops that were conducted on August 24 and 25, 2016 to educate users about the Manual, were funded in part by a Section 319 Nonpoint Source Management Program Implementation grant from the U.S. Environmental Protection Agency through an agreement/contract with the Nonpoint Source Management Section of the Florida Department of Environmental Protection.

DISCLAIMER

While many developments share common elements, each is unique. The information in this Manual is intended only as a starting point and guidance for the reader and should be used only with careful consideration of applicable laws, rules, codes, ordinances, and standards in effect at the time of a specific development. This Manual does not change the laws applicable to planning, designing, constructing, operating, and maintaining building and development projects in Escambia County, Florida.

The information is supplied on the condition that the reader will make his or her determination as to its suitability for his or her purposes. The responsibility for using a standard in this Manual remains with the professional or other person responsible for planning, designing, constructing, operating, and maintaining a specific project.

The use of brand names in this publication does not indicate an endorsement by the authors, Escambia County, the State of Florida, or the United States Environmental Protection Agency.

This Manual was prepared by:

Dr. Martin P. Wanielista, P.E.
University of Central Florida
Orlando, Florida

Mr. Eric H. Livingston
Watershed Management Services, LLC
Crawfordville, Florida

EXECUTIVE SUMMARY

Like much of Florida, Escambia County continues to become more urbanized as the population and the number of tourists increases. To better protect the county's surface and ground water resources, the County has implemented a Comprehensive Plan and Land Development Code. To promote better site planning and stormwater management, the County has recognized the need to expand the stormwater management "tool box". Accordingly, the County applied to the Florida Department of Environmental Protection for Section 319 Nonpoint Source Management grant funds for the development of the Escambia County Low Impact Design BMP Manual.

This Manual was created to promote a more comprehensive and systematic approach to project stormwater design. Stormwater management, including flood control and improved stormwater treatment, needs to be approached in a holistic manner considering the setting, natural hydrology, existing conditions, project type, and community character. Stormwater management needs to be focused and integrated into the projects' core design using a variety of methods for addressing stormwater in an urbanizing community. The Low Impact Design BMP Manual provides new tools that can be integrated into a BMP Treatment Train to not only improve stormwater management, but also expand development potential and enhance project aesthetics.

LID is a stormwater and land use management strategy that strives to mimic pre-disturbance hydrologic processes of infiltration, filtration, storage, evaporation, and transpiration. LID emphasizes conservation, use of on-site natural features, improved site planning, and distributed stormwater management practices that are integrated into a project's design, especially its landscaping and open space. It emphasizes the combining of a series of BMPs into a BMP Treatment Train that is fully integrated into a site plan and the site's landscaping.

The Manual consists of six chapters and three technical appendices. Chapter 1 provides a brief overview of each chapter and appendix. It also includes a list of acronyms and a definitions section. Chapter 2 summarizes the local conditions that exist in Escambia County, especially those that influence stormwater and stormwater management design. Chapter 3 discusses the stormwater problem, conventional BMP approaches, and introduces Low Impact Design. Chapter 4 further discusses stormwater treatment processes and explains how to calculate stormwater pollutant loadings and evaluate the treatment effectiveness of LID BMPs. Chapter 5 is the BMP Catalog, containing 12 Site Planning BMPs, 10 Source Control BMPs, and 13 Structural LID BMPs. Very detailed and specific design criteria are included for the structural LID BMPs that are consistent with those being approved by DEP and the WMDs. Chapter 6 discusses the State Environmental Resource Permitting program and how the LID BMPs contained in this Manual can be permitted.

This Manual should be used in conjunction with the Escambia County Comprehensive Plan and Land Development Code. The standards, herein, align with the State of Florida Environmental Resource Permit (ERP) and the administrative standards established by the Northwest Florida Water Management District (NFWFMD). The County, through its codes and policies, will allow design flexibility while establishing quantity/quality goals to ensure a sustainable future.

CHAPTER 1 - INTRODUCTION

1.1. Purpose and Intended Users

The Escambia County Low Impact Design BMP Manual (herein after called “Manual”) describes [Low Impact Design \(LID\)](#) principles, strategies and [Best Management Practices \(BMPs\)](#) applicable to all types of [development](#) and [redevelopment](#) projects in Escambia County, Florida. It is intended to be a LID BMP design and permitting guidance and reference tool to facilitate the design, permitting, and construction of stormwater treatment systems that incorporate LID BMPs. The Manual establishes standard design criteria for LID BMPs that are updated versions of the ones currently being used informally by DEP and the WMDs. Potential users range from developers and landowners to site planners, design engineers, and landscape architects to individual builders and contractors. While there are distinct differences between what the County deems a “conventional” vs. an “LID” project, many LID technical concepts, design criteria, and specifications are, in practice, very similar to conventional approaches. The goal of promoting, constructing and monitoring LID projects is one of the county’s long-term strategies to achieve measurable improvements in local water quality, preserve and protect valuable natural resources, and enhance residents’ quality of life.

The stormwater LID BMPs described in this Manual should be considered as a supplement to, and not a replacement of, the current stormwater management regulations of the County, Water Management Districts, and any other applicable regulations. These newer BMPs provide increased flexibility to achieve better stormwater treatment, flood control, and increased aesthetics, along with increased developed potential. It is the County’s intention that this Manual will be adopted as a supplement to the County’s Design Standards in the Escambia County Land Development Code.

1.2. Organization of the Manual

The Escambia County Low Impact Design Manual contains six chapters and three appendices to provide guidance on the planning, design, construction, operation, and maintenance of LID BMPs. A summary of each chapter follows:

1.2.1. Chapter 1: Introduction

Along with establishing the purpose of the Manual, and its intended users, Chapter 1 includes a list of Acronyms and definitions of terms used in the Manual.

1.2.2. Chapter 2: Escambia County Context

Chapter 2 provides an overview of the natural resources of Escambia County with a focus on those that have a significant effect on the generation and management of stormwater. This includes information on the County’s geomorphology, topography, rainfall, soils, water tables, wetlands, and surface waters. A list of the County’s water bodies and their impairment status is summarized in [Appendix C](#).

1.2.3. Chapter 3: Improved Site Design: Evaluating and Master Planning a Site

Chapter 3 discusses the changes in stormwater resulting from urbanization, the goals of stormwater management, an overall introduction to stormwater management, and a discussion of the BMP treatment train concept. The Chapter then introduces Low Impact Design and discusses its principles, goals, advantages, and disadvantages. A discussion of the importance

of Improved Site Design that better integrates land and water site planning to improve stormwater treatment and management concludes the chapter.

1.2.4. Chapter 4: Evaluating Stormwater Treatment Effectiveness

Chapter 4 provides additional information on stormwater treatment processes and how they can be integrated into an effective [BMP Treatment Train](#) using Low Impact Design BMPs. The performance standards establishing the minimum level of stormwater treatment are summarized. This includes the “Net Improvement” performance standard for waters within Escambia County and Florida that are not meeting applicable water quality standards (impaired waters). Since this requires the post-development load to be less than the pre-development stormwater pollutant loadings, this Chapter guides user through this process, along with evaluating the pollutant load reduction of BMPs. Tools that can be used for these calculations are discussed.

1.2.5. Chapter 5: LID BMPs for Escambia County

Chapter 5 provides technical guidance for Low Impact Design BMPs - Site Planning BMPs, Source Control BMPs, and Structural BMPs – tailored to Escambia County conditions. For each of the following Structural LID BMPs, detailed design criteria and technical guidance are provided for their design, construction, inspection, operation, and maintenance:

Volume Reduction BMPs

- Retention areas
- Exfiltration trenches
- Underground retention systems
- Bioretention systems (Rain Gardens)
- Treatment swales
- Vegetated natural buffers
- Pervious pavements
- Green roofs with cisterns
- Rainwater harvesting
- Stormwater harvesting

Concentration Reduction BMPs

- Up flow filters
- Managed Aquatic Plant Systems (MAPS)
- Biofiltration systems with Biosorption Activated Media (BAM)

Each LID BMP section in Chapter 5 begins with an overview table that highlights the most critical information for the specific LID practice covered in that section.

1.2.6. Chapter 6: Regulatory Framework for LID BMPs

Chapter 6 discusses the regulatory framework for Florida’s stormwater treatment program and for using LID BMPs. The NFWFMD ERP Applicant’s Handbook Volume II does not include many of the more common LID BMPs found in this Manual. However, the LID BMP design criteria in Chapter 5 are consistent with those developed by DEP and the WMDs in 2010. Those design criteria have been updated in this Manual using the most recent LID BMP monitoring

results from projects in Florida. The NFWFMD and DEP will issue ERPs to projects that elect to use LID BMP treatment systems or use the LID BMPs in conjunction with other traditional water quality treatment BMPs.

1.2.7. Appendices

The Appendices contain reference documents and data providing necessary information and/or further technical guidance for the design, construction, and maintenance of Chapter 5 LID BMPs. [Appendix A](#) contains tables providing the performance effectiveness (average annual load reduction) of varying treatment volumes for retention BMPs as a function of % DCIA and non-DCIA curve number. [Appendix B](#) contains methodologies to evaluate retention systems and to obtain geotechnical data to ensure adequate percolation of stormwater. [Appendix C](#) is a list of all of the water bodies in Escambia County for which the FDEP has assigned Water Body Identification (WBID) numbers and the current status of their health, including whether it is Verified Impaired, or if a Total Maximum Daily Load (TMDL) or Basin Management Action Plan (BMAP) has been adopted.

1.3. List of Acronyms

BAM	= Biosorption Activated Media
BMAP	= Basin Management Action Plan
BMP	= Best Management Practice
CN	= Curve Number
EIA	= Equivalent Impervious Area
ERP	= Environmental Resource Permit
FAC	= Florida Administrative Code
FDEP	= Florida Department of Environmental Protection
FS	= Florida Statute
LDC	= The Escambia County Land Development Code
LID	= Low Impact Development or Low Impact Design
NFWFMD	= Northwest Florida Water Management District.
R.T.V	= Required Treatment Volume
SHGWT	= Seasonal High Water Table
TMDL	= Total Maximum Daily Load
WBID	= Water Body Identification

1.4. Terminology and Definitions

Average Annual Load Reduction. An estimate of the long-term average reduction in annual pollutant loading provided by a BMP or stormwater management system. This is typically expressed as a percentage.

Average Annual Rainfall. The long-term average rainfall that occurs annually (See Figure 4-3)

Basin Management Action Plan (BMAP). A "blueprint" for restoring impaired waters by reducing pollutant loadings to meet the allowable loadings established in a Total Maximum Daily Load (TMDL). These implementation plans are developed with local stakeholders--they rely on local input and local commitment--and they are adopted by Secretarial Order to be enforceable.

Bioretention. Also see Rain Garden. A LID BMP consisting of a shallow landscaped depression with soils, mulch, and planted vegetation intended to capture, treat, and infiltrate stormwater runoff.

Best Management Practice or BMP. Structural and non-structural control techniques used to manage stormwater for a given set of conditions to enhance stormwater quantity and quality in a cost effective manner.

Biofiltration. A LID BMP that incorporates an engineered soil or media, such as Biosorption Activated Media (BAM), to either enhance pollutant removal, or facilitate infiltration and treatment. Examples include using BAM in the bottom of retention BMPs to promote denitrification or using BAM in up-flow filters at the discharge of wet detention systems to increase pollutant load reduction.

Biosorption Activated Media (BAM). Engineered media for use in stormwater BMPs to increase the removal of pollutants, especially nutrients.

BMP Treatment Train. A series of complementary BMPs that are integrated into an effective stormwater management system with each BMP providing incremental stormwater attenuation and/or treatment benefits

Cistern. A closed reservoir or tank used for storing stormwater for rainwater harvesting.

Control Elevation. The lowest elevation at which stormwater can be released through a control device in a stormwater management system.

Curve Number. An empirical parameter used in hydrology for determining the approximate amount of direct runoff from a rainfall event in a particular area.

Density. The number of residential dwelling units permitted per gross acre of land as determined by the Escambia County Zoning regulations.

Detention. The collection and temporary storage of stormwater with subsequent gradual release of the stormwater.

Development. The carrying out of any building activity or mining operation, the making of any material change in the use or appearance of any structure or land, or the dividing of land into three or more parcels (subdivision).

Directly Connected Impervious Area (DCIA). Impervious areas that are hydraulically connected directly to the stormwater conveyance system and then to the basin outlet point without flowing over pervious areas.

Easement. A limited right to use the land of another for a specific purpose, typically granted to the benefit of adjoining landowners for public or private access, utilities, stormwater management, or similar use over an area of land whose title remains in the name of the landowner, subject to the designated right of use.

Environmentally Sensitive Lands. Those areas of land or water determined by the Board of County Commissioners to be necessary to conserve or protect natural habitats and ecological systems. Those areas are specifically enumerated within the natural resources provisions of Chapter 4 of the Land Development Code.

Equivalent Impervious Area (EIA). The area of a completely impervious watershed that would produce the same volume of runoff as the actual watershed.

Eutrophication. The process by which a body of water becomes enriched in dissolved nutrients that stimulate the growth of aquatic plant life usually resulting in the depletion of dissolved oxygen.

Event Mean Concentration (EMC). Refers to a flow-weighted average concentration of pollutants in stormwater. It is defined as the total pollution load mass divided by the total runoff volume for a storm event.

Floodplain. Any land area inundated by flood events of various recurrence intervals as defined by the latest Federal Emergency Management Agency (FEMA) Flood Insurance Rate Map (FIRM), Escambia County Basin Studies, or whichever data are, in the determination of the County, more accurate.

Florida-friendly Landscaping. Landscape that is designed in accordance with the nine principles of Florida-friendly landscaping. Such landscapes reduce the amount of turf areas and replace them with ground covers or other native plants that require less fertilization and irrigation.

Florida-friendly Fertilizers. Fertilizers specifically approved and formulated for use on urban landscapes. They contain little or no phosphorus, at least 25% slow release nitrogen, and meet the requirements set in Rule 5E-1.003, F. A. C.

Greenfield Development. New development that occurs on lands that have not previously been developed. Such lands range from those with a variety of natural features and resources to cleared agricultural lands.

Greenroof. A roof area built to the specifications of this Manual that includes vegetation, media, and a waterproof membrane. To receive water quality credit, it is specifically built with a cistern or water holding system from which irrigation is provided.

Graywater. That part of domestic sewage that is not carried off by toilets, urinals, and kitchen drains. Graywater includes waste from the bath, lavatory, laundry, and sink, except kitchen sink waste.

Ground Water. Water that fills all the unblocked voids of material below the ground surface to an upper limit of saturation, or water that is held in the unsaturated zone by capillarity.

Harvested Rainwater. Runoff from a roof that is conveyed into a cistern or other storage system and then used. Harvested rainwater may be used for landscape irrigation, vehicle washing, or in other outdoor non-potable applications.

Harvested Stormwater. Stormwater that is obtained from either retention or detention BMPs using a horizontal well or sand filter and then used similarly to harvested rainwater. Generally used with wet detention systems to reduce the volume of stormwater that is discharged thereby increasing the average annual pollutant load reduction of the system.

Heritage Trees. A protected tree 60 inches or greater in diameter (Diameter at Breast Height). Such large mature trees providing proportionately more of the benefits associated with trees, and often defining the local landscape, shall have a greater protected status as prescribed in this article.

Impaired Water. A water body or water body segment that does not meet its applicable water quality standards as set forth in Chapters 62-302 and 62-4, F.A.C., as determined by the methodology in Part IV of Chapter 62-303, F.A.C., due in whole or in part to discharges of pollutants from point or nonpoint sources.

Impervious. Surfaces that do not allow, or minimally allow, the penetration of water, including semi-impervious areas, but excluding wetlands or other surface waters. Such highly impermeable surfaces include structure roofs, regular concrete and asphaltic pavements.

Invasive Species. A non-indigenous or exotic species that is not native to the ecosystem under consideration and that has the ability to establish self-sustaining, expanding, free-living populations that may cause economic and/or environmental harm, or harm to human health. They are set forth in State regulations (Chapters 5B-57.007 and Chapter 62C-52.011 of Florida Administrative Code), the Florida Exotic Pest Plant Council's list of Category I and II invasive species as appropriate to this geographic region,

Landscape Plant. Any native plant or plant listed in the Florida-friendly Landscaping Guide to Plant Selection and Landscape Design.

Littoral Zone. That portion of a wet detention system adjacent to the shoreline consisting of a shallow slope that is planted with rooted plants.

Load Reduction Credit. An estimate of the average annual pollutant load reduction achieved by a BMP that can be counted towards the overall average load reduction achieved by the stormwater management system.

Low-Impact Design. A stormwater management approach that uses a suite of BMPS (structural and non-structural) distributed throughout the site and integrated as a BMP Treatment Train (i.e., in series) to replicate the natural hydrologic functioning of the landscape and to reduce the average annual stormwater pollutant loading discharged off-site.

Native Vegetation. Indigenous, naturally occurring plants, adapted to county climate and soil conditions as determined through authoritative reference guides such as the *Florida-Friendly Plant List*, University of Florida, IFAS Extension

Nuisance Vegetation. A species that threatens native species' abundance or diversity or the stability of an ecosystem or ecosystem process by its aggressive growth habit.

Nutrient-Absorption Layer. A layer of Biosorption Activated Media (BAM) within a filter or used in retention or detention BMPs to increase nutrient absorption or facilitate the Nitrogen Cycle, thereby reducing the nutrient loading from the stormwater system.

Non-Directly Connected Impervious Area. All pervious areas and those portions of impervious areas that flow over at least 10 feet of pervious areas with HSG A or B soils and over at least 20 feet of pervious area for other soil types.

Open Space. Land or portions of land preserved and protected, whether public or privately owned, and perpetually maintained and retained for active or passive recreation, for resource protection, or to meet lot coverage requirements. Open space includes required yards, developed recreation areas and improved recreation facilities, natural and landscaped areas, and common areas.

Pervious Surface. Any surface that easily allows the infiltration of water. Such permeable or porous surfaces include natural or landscaped vegetation and other surfaces that allow infiltration.

Pervious Pavement. A pavement system that allows stormwater to infiltrate into the parent soil.

Post-development. Conditions that will exist on a site after the site is developed or redeveloped.

Pre-development. Conditions that exist on a site at the time of permit application. Unauthorized site preparation activities will not be considered as predevelopment conditions.

Protected Tree. A living tree that, according to the Section 2.3 of the LDC, cannot be removed or otherwise willfully harmed without first obtaining appropriate authorization from the county.

Pretreatment. Structural or non-structural BMPs that are applied upstream from or before capture, storage, treatment, and/or harvesting by subsequent downstream stormwater BMPs.

Rain Barrel. A rainwater storage vessel with a capacity less than or equal to 80 gallons that captures runoff from a roof. Systems using rain barrels for storage, including systems that link several barrels together in series, do not constitute an acceptable BMP for the Environmental Resource Permit program administered by the Northwest Florida Water Management District.

Reclaimed Water. Wastewater that has received at least secondary treatment and which is reused after flowing out of a wastewater treatment facility.

Redevelopment. The removal and replacement, rehabilitation, or adaptive reuse of an existing structure or structures. The rehabilitation or adaptive reuse of land from which previous improvements have been removed.

Registered Professional. A professional registered or licensed by and in the State of Florida and who possesses the expertise and experience necessary for the competent preparation, submittal and certification of documents and materials, and performing of other services required in support of permitting, constructing, altering, inspecting, and operating a proposed or existing regulated use. Registered professionals include engineers, architects, surveyors and mappers, and geologists.

Retention. A BMP designed to prevent the discharge of a given volume of stormwater runoff into surface waters in the state by providing complete on-site storage. Examples include retention basins that are excavated or natural depression storage areas, exfiltration trenches, rain gardens, swales, and pervious pavement with subgrade.

Seasonal High Ground Water Table (SHGWT). The elevation to which the ground and surface water can be expected to rise during a normal wet season.

Semi-Impervius Surface. Any surface that is more resistant to the infiltration of water than a pervious surface, but more easily allows infiltration than an impervious surface. Such moderately impermeable surfaces include compacted stone, gravel, asphalt, shell, or clay serving vehicular traffic; pervious paver stones and pavements.

Soils. Defined in the current United States Department of Agriculture Natural Resources Conservation Service Soil Survey of Escambia County, Florida

Stormwater. The flow of water that results from, and that occurs immediately following, a rainfall event.

Stormwater Harvesting. A LID BMP that captures stormwater that is reused thereby reducing the stormwater volume and pollutant loading discharged off-site.

Stormwater Harvesting Rate. The rate at which stormwater is harvested, which is typically expressed in inches per day.

Stormwater Harvesting System. A stormwater management system that includes a modified control structure to hold water, a horizontal well or sand filter, flow meters, and an irrigation system or other type of system that will use the harvested stormwater for beneficial purposes.

Stormwater Management Plan. A professionally certified plan to manage stormwater runoff from development by providing concurrent control of erosion, water quality, sedimentation, and flooding in compliance with all applicable regulatory authorities.

Stormwater Management System. A surface water management system that is designed and constructed or implemented to control discharges which are necessitated by rainfall events, incorporating methods to collect, convey, store, absorb, inhibit, treat, use, or reuse water to prevent or reduce flooding, over drainage, environmental degradation, and water pollution or otherwise affect the quantity and quality of discharges from the system.

Total Maximum Daily Load (TMDL). The maximum allowable average annual loading to an impaired water body that will allow the water body to meet its applicable water quality standards. A TMDL is adopted by FDEP and represents the sum of the individual wasteload allocations for point sources and the load allocations for nonpoint sources and natural background for an impaired waterbody or waterbody segment. A TMDL includes either an implicit or explicit margin of safety or a consideration of seasonal variations. (Chapter 62-302.200, F.A.C.)

Turf Grass. Grass species normally grown as permanent lawns in Escambia County.

Water Body. A natural body of water including rivers, lakes, streams, springs, ponds, and all other natural bodies of water including tidal, fresh, brackish, and saline.

Water Body Identifier or WBID. A water body assessment unit representing a relatively homogenous and hydrologically distinct segment of a major surface water body. Each assessment unit is represented by a unique waterbody identifier (WBID number) and is characterized by waterbody type (including rivers/streams, lakes, estuaries, coastal waters, and beaches) and a waterbody class.

Water Quality Standards. Standards composed of designated present and future most beneficial uses (classification of waters), the numerical and narrative criteria set forth in Chapters [62-4](#), [62-302](#), [62-520](#), and [62-550](#), F.A.C., and the anti-degradation provisions of paragraphs 62-4.242(1)(a) and (b), F.A.C., subsections 62-4.242(2) and (3), F.A.C., and Rule 62-302.300, F.A.C.

CHAPTER 2 – LOCAL CONTEXT

2.1. Introduction

This Chapter provides an overview of the natural resources of Escambia County and how they may affect the feasibility and effectiveness of different types of stormwater BMPs. The resources to be discussed include geomorphology, average annual rainfall, soil types with emphasis on the Hydrologic Soil Groups in Escambia County, water table conditions, surface water resources, and the impairment status of water bodies.

2.2. Local Hydrologic and Water Resource Context

Escambia County is the westernmost county in Florida. The county extends about 50 miles from the Gulf of Mexico to the Florida-Alabama state line. The Perdido River forms the western boundary, the Escambia River forms the eastern boundary, and the Gulf of Mexico is the southern boundary. The county contains 875 square miles, with 656 square miles of land and 218 square miles of water. The estimated population in 2015 was 311,003.

2.2.1. Geomorphology

Escambia County is situated in the Northern geomorphology zone. This zone includes the northernmost Florida peninsula and the entire Panhandle. The Northern Zone is subdivided into two geomorphic provinces: The Western Highlands (tan on map) and the Gulf Coastal Lowlands (green on map). The Western Highlands comprise the northern three-quarters of Escambia County. The terrain is characterized by gently rolling clayey-sand hills and ridges, punctuated by a series of deeply-incised streams. Land surface elevations range from 280 feet above mean sea level (MSL) near the Alabama-Florida state line to approximately 100 feet above MSL at the southern end of the highlands (Rupert, 1993).

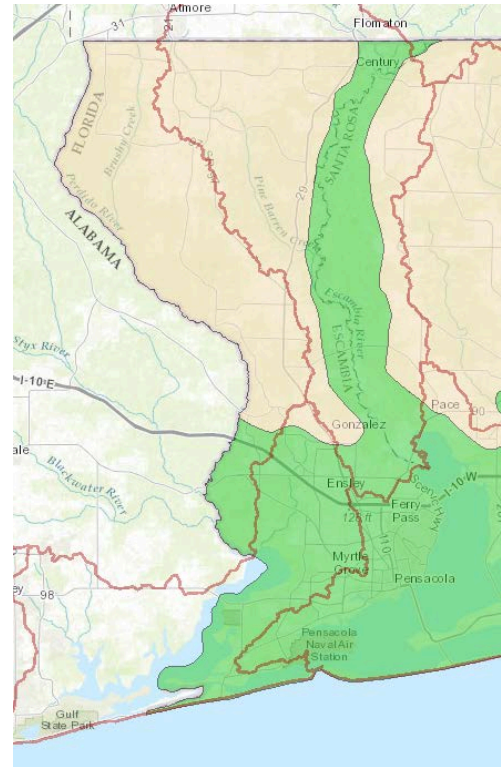

The Gulf Coast Lowlands zone covers the southern one-quarter of the county. It extends primarily from the southern edge of the Western Highlands to the coastline. A relic marine escarpment, lying at an elevation of approximately 100 to 120 feet above MSL, marks the boundary between the two geomorphic provinces. The Gulf Coast Lowlands includes the Escambia River valley and the coastal barrier islands. The terrain is generally flat and sandy with gentle slopes from an elevation of about 100 feet above MSL to 0 feet MSL near the coast. Much of the land adjacent to Perdido Bay and landward of the barrier islands is flatwoods with slowly draining soils.

2.2.2. Rainfall Characteristics

The Florida Panhandle is the rainiest region in Florida. Escambia County typically receives between 65 and 66 inches of precipitation annually (Figure 4.2). About 27 inches, or about 42%, of the rain falls during June through September. The greatest amount of rain falls in July and

August. The least amount falls in April. In summer. Winter brings gentle rains of longer duration, usually 1 to 3 days.

Escambia County’s rainfall characteristics are similar to other counties in Rainfall Zone 1 as delineated by [Harper and Baker \(2007\)](#). The meteorological hourly data indicates that approximately 85% of Pensacola’s 126 mean annual rainfall events are less than 1 inch in volume, with approximately 46% of all rainfall events less than 0.10 inch. The mean number of dry days between rain events (Inter-Event Time) in West Florida is 3.4 days during the dry season and 1.99 days during the wet season. (Harper and Baker, 2007).

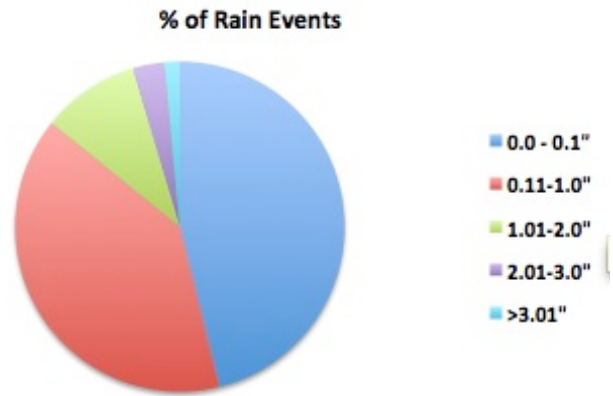

2.2.3. Hydrologic Soil Properties

Escambia County has a diverse set of soils with different hydrological properties. They range from excessively drained sandy soils to poorly drained loamy or clay soils. Understanding the soil properties of a specific site can help determine stormwater management design and features necessary to maximize efficiency and effectiveness of a given stormwater management design. **Two of the most important site characteristics that will determine the type and nature of stormwater BMPs that can be successfully used at any site are the hydrologic soil types and the seasonal high water table conditions.** This is especially true for [retention BMPs](#) that have the greatest potential to reduce stormwater volumes and pollutant loadings discharged to surface waters. Soils with good infiltration potential (aka low runoff potential) should be considered as optimal locations for [Low Impact Design](#) (LID) stormwater management practices that require infiltration.

The USDA Natural Resources Conservation Service revised the Escambia County Detailed Soil Survey between 2013 and 2015. This on-line [publication](#) provides good information about the soil types in Escambia County and their properties including data on the elevation of the seasonal high water table. Figure 2.1 shows the location of the soil types in Escambia County based on their Hydrologic Soil Groups.

The NRCS classifies soils into Hydrologic Soil Groups (HSG). HSGs are categorized according to the percolation rate of water when the soils are thoroughly wet and receive precipitation from long-duration storms. Group A soils are generally deep, well-drained sands with high infiltration rate and low runoff potential. These soils also have a high rate of water transmission and cover 45.5% of the county, mainly south of Interstate 10. Retention BMPs work very well on HSG A soils. Retention BMPs also work well on Group B soils, which cover 6.3% of the county. They have a moderate infiltration rate and moderate rate of water transmission. Additionally, HSG B/D soils are common covering 18.6% of the county. Group C soils cover 18.6% of the county. They have a slow infiltration rate when thoroughly wet, and consist primarily of fine textured soils with a slow rate of water transmission. Group D soils have a very slow infiltration rate and very slow rate of water transmission. These soils generally have a high clay component and high runoff potential Table 2.1 below summarizes the characteristics of the HSG classifications.

Figure 2.1. Escambia County Hydrologic Soil Groups Distribution

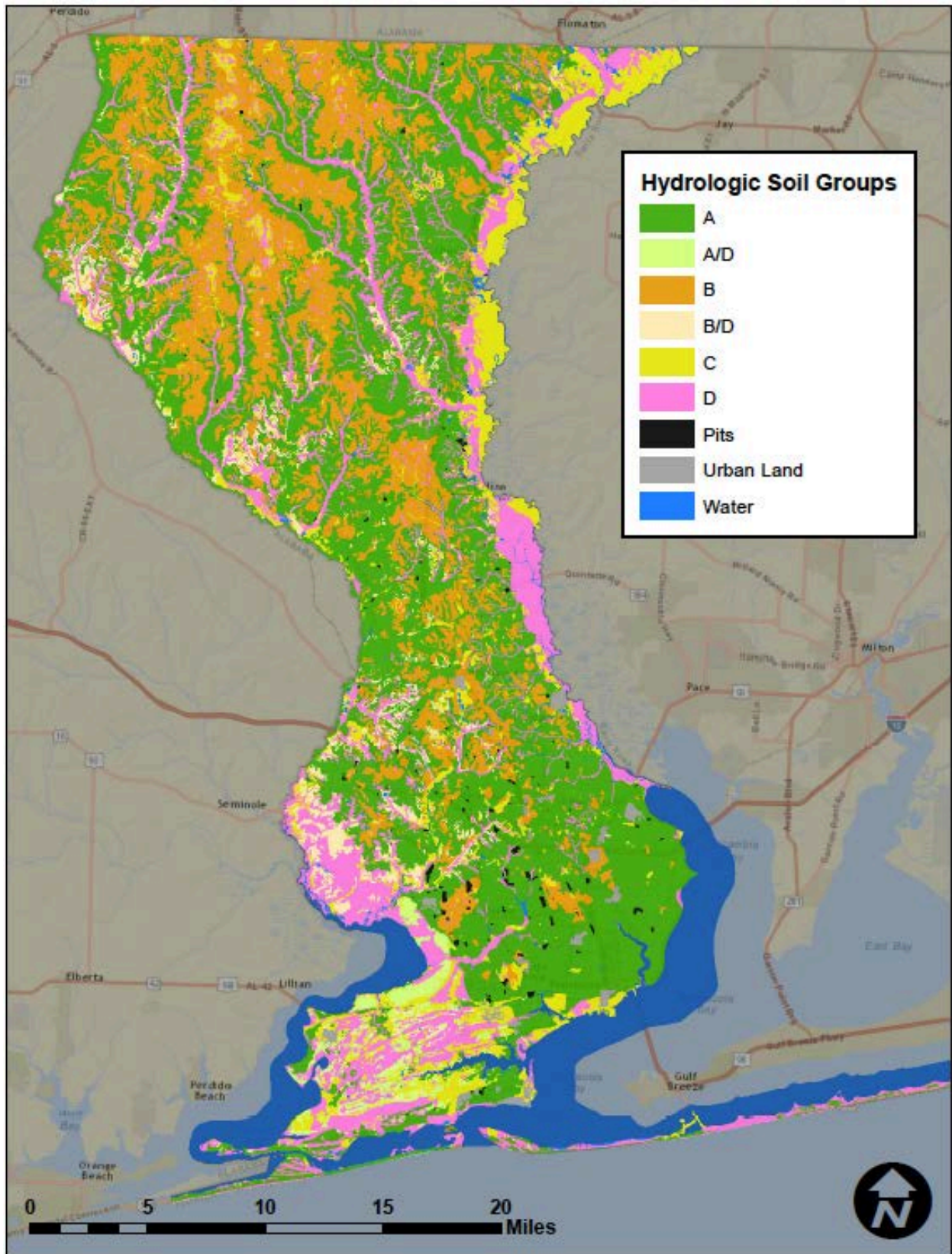
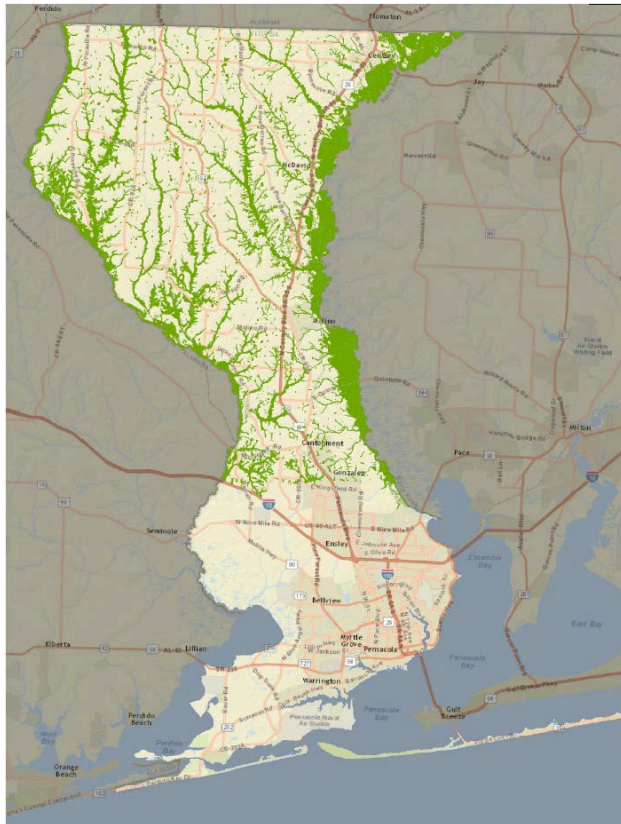

Table 2.1. Characteristics of NRCS Hydrologic Soil Groups Classifications

Hydrologic Soil Group	Infiltration Rate		Water Transmission Rate	Runoff Potential	Areal Extent of County (%)
	When Dry	When Wet			
A	High	High	High	Low	45.5%
B	Moderate	Moderate	Moderate	Moderate	6.3%
C	Slow	Slow	Slow	High	18.6%
D	Very Slow	Very Slow	Very Slow	Very High	0.0%
A/D	High	Slow	Variable	High	5.7%
B/D	High	Very Slow	Variable	Very High	22.1%
C/D	Moderate	Very Slow	Variable	Very High	1.7%

2.3.5. Escambia County Surface Waters and Watersheds

Figure 2.2. Escambia County Water Bodies and Wetlands



The surface water systems of Escambia County include areas of standing and flowing water, as well as the wetlands and floodplains associated with them. The Escambia and Perdido rivers continue to meander through broad floodplains. However, many of the inland creeks and streams have seen their floodplains and channels constricted by urbanization and agriculture or otherwise been modified for flood control.

Surface water types in Escambia County include sand-bottomed creeks, tannic creeks, large streams, lakes, ponds, and wetlands. The county’s underlying geology and soils have a profound influence on the location of surface water bodies,

A watershed is an area of land that drains to a receiving body of water. For example, stormwater runoff from lawns and driveways travels down the street along the gutter to a storm drain then runs through underground pipes to a neighborhood pond or stream. From there it drains to downstream receiving waters such as the Escambia River, Escambia Bay,

Pensacola Bay, or one of the many bayous. Escambia County has 37 designated watersheds as see below in Figure 2.3.

Figure 2.3. Escambia County Watersheds

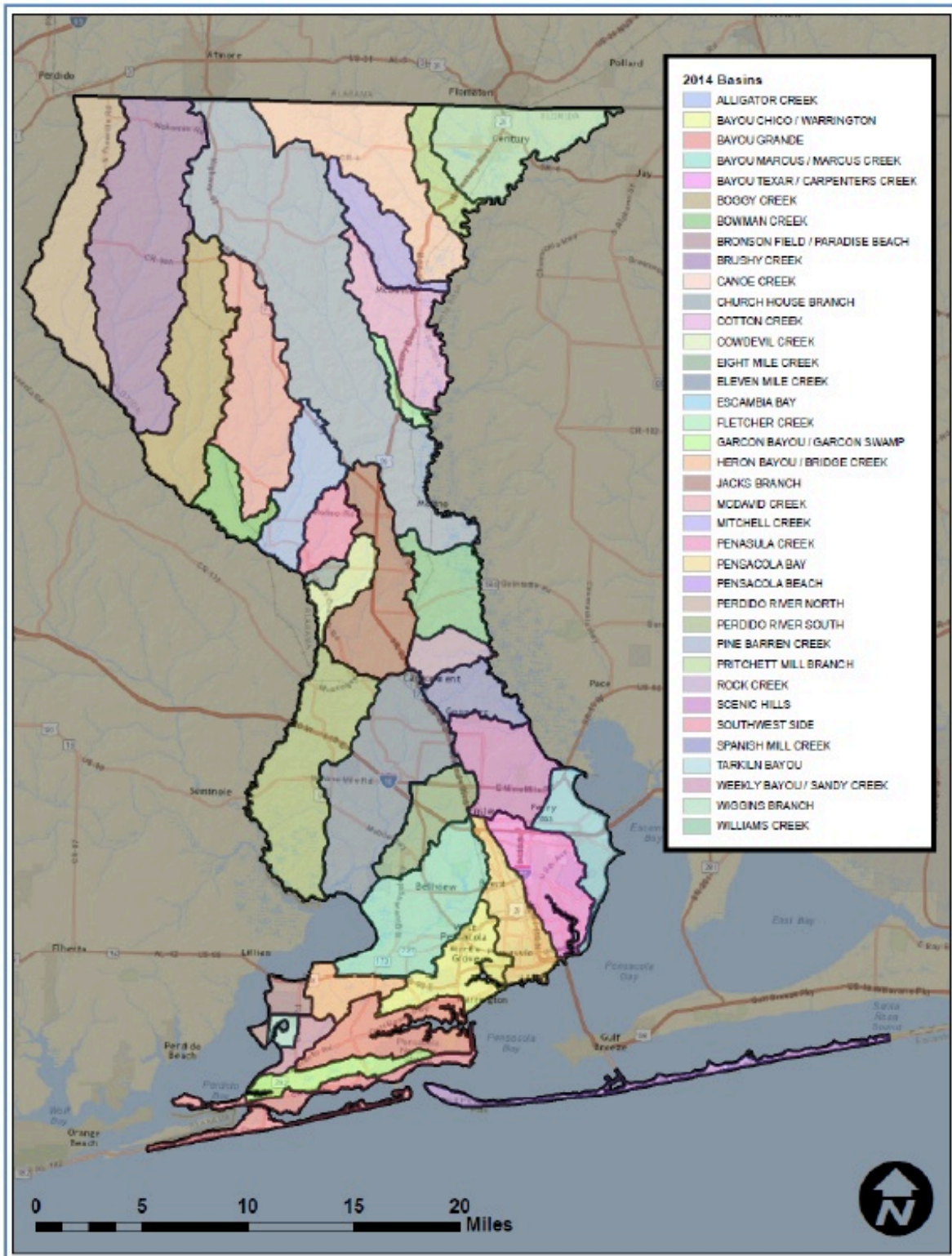

Escambia County, in cooperation with the NFWFMD, FDEP, and other entities, conducts monitoring of its water bodies to determine their health. As part of the state's Rotating Basin Cycle, the FDEP conducts assessments of water body health on a five-year schedule. The product of this assessment is a list of all water bodies within a basin and their current health status. Information about these assessments is available online at:

DEP Watershed Assessment - <http://www.dep.state.fl.us/water/watersheds/assessment/>

As part of the water body assessment, a list of water bodies that do not meet the state's water quality standards is produced. This is called the Verified List of Impaired Surface Waters. These [impaired waters](#) undergo a long term planning and implementation process to restore their beneficial uses and meet [water quality standards](#) by reducing pollutant loadings discharged into them from throughout their watershed. This process includes the development and adoption of [Total Maximum Daily Loads](#) (TMDLs) that establish the pollutant loading capacity for a water body to be healthy and the pollutant load reductions that must be done in the watershed to meet the TMDL and restore the water body. In many cases, [a Basin Management Action Plan \(BMAP\)](#) is prepared by DEP and watershed stakeholders to create a blueprint for reducing pollutant loads and restoring the water body's health.

[Appendix C](#) lists the major receiving waters in Escambia County that have been [assigned Water Body Identification Numbers \(WBIDs\)](#) by FDEP. This table also includes information about the impairment status of these water bodies along, whether a Total Maximum Daily Load (TMDL) or Basin Management Action Plan (BMAP) has been adopted for the water body, and the required pollutant load reduction to restore the water body. This information is current as of September 2016. For more recent information, please see the web sites below.

- The adopted Verified Lists of Impaired Waters are available online at: <http://www.dep.state.fl.us/water/watersheds/assessment/a-lists.htm> - al
- The adopted Total Maximum Daily Loads are listed in Chapter 62-304, F.A.C. It is available online at; <https://www.flrules.org/gateway/ChapterHome.asp?Chapter=62-304>
- The adopted TMDL documents are on-line at: http://www.dep.state.fl.us/water/tmdl/final_tmdl.htm
- The adopted BMAPs are on-line at: <http://www.dep.state.fl.us/water/watersheds/bmap.htm>

2.3.6. Discharges to Escambia County Water Bodies

Escambia County has adopted by reference the State of Florida's [Water Quality Standards](#) that are adopted in [Chapter 62-302](#), Florida Administrative Code. Under Florida law (Chapters 373 and 403, Florida Statutes), most discharges to Florida water bodies are not allowed without a permit. To obtain a permit one must demonstrate that the discharge will not cause or contribute to violations of water quality standards in the receiving water body. If a water body fails to meet water quality standards under existing conditions, including any water body on the Verified List of Impaired Waters or with an adopted TMDL, no additional discharges of the pollutant causing the water body impairment are allowed. However, [Section 373.414\(1\)\(b\)3., F.S.](#), allows one to obtain a permit to discharge to an impaired water body if one can demonstrate "net environmental improvement". This means that the average annual pollutant loading in the new discharge must be less than is currently being discharged from the site.

Because of the number of impaired water bodies in Escambia County, many future development and redevelopment projects will be required to meet the "net improvement" treatment standard for their stormwater discharges. The Escambia County Low Impact Design BMP Manual has

been developed to expand the “stormwater BMP toolbox” to allow projects to proceed cost-effectively while meeting these higher stormwater treatment requirements.

2.3.7. References

1. [Geomorphology and Geology of Escambia County, Florida](#). 1993. Frank R. Rupert. Open File report 59, Florida Geologic Survey, Tallahassee, Florida.
2. [Evaluation of Current Stormwater Design Criteria within the State of Florida](#). 2007. Harvey H. Harper, Ph.D., P.E., and David M. Baker, P.E., Environmental Research and Design, Inc.
3. [Detailed Soil Survey of Escambia County](#). 2004, U.S. Department of Agriculture, Natural Resources Conservation Service.

CHAPTER 3 – IMPROVED SITE DESIGN: EVALUATING AND MASTER PLANNING A SITE

3.1. Introduction

This chapter provides a brief overview of the changes in stormwater characteristics associated with urbanization; the goals of stormwater management; and a discussion of stormwater pollutants and removal mechanisms. The chapter also includes a discussion of essential site planning requirements and introduces Low Impact Design concepts, strategies, and techniques that provide new tools for stormwater management.

3.2. Changes in Stormwater Characteristics from Urban Development

3.2.1. Changes in Urban Hydrology

Urban development changes the physical alteration of the natural landscape and creates changes in land use and human activities. These can cause a litany of adverse impacts to general land conditions, watershed hydrology and pollutant loading, surface and ground water quality, and natural systems, such as freshwater wetlands and floodplains.

Development and redevelopment activities remove natural vegetation, compact soils, and add impervious surfaces such as roads, parking areas, sidewalks, and rooftops. These changes reduce, disrupt, or entirely eliminate native vegetation, upper soil layers, shallow depressions, and natural drainage patterns that intercept, evaporate, store, slowly convey, and infiltrate stormwater. As urbanization occurs, the areas that contribute stormwater to receiving waters increase while the areas that naturally manage stormwater diminish.

Figure 3.1. Stormwater flow changes associated with urbanization.

The blue line represents the predevelopment hydrograph and the brown line is the post-development hydrograph. (Source: U.S. Environmental Protection Agency)

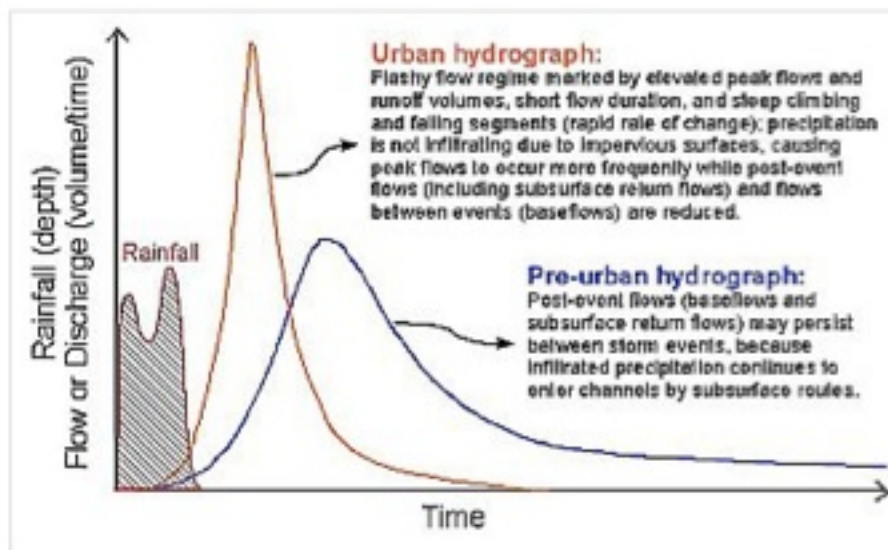

The hydrologic and hydraulic effects of these activities include reduced infiltration and ground water recharge, increased stormwater peak discharge rate and volume, increased pollutant loadings, and increased erosion and sedimentation. These common consequences of urban development lead to lowering of ground water tables; altered stream flows; altered wetland and lake water levels; an increased magnitude and frequency of flooding; and increased water pollution. Figures 3.1 and 3.2 summarize the changes in hydrology associated with the urbanization process.

Figure 3.2. How Impervious Cover Affects the Water Cycle

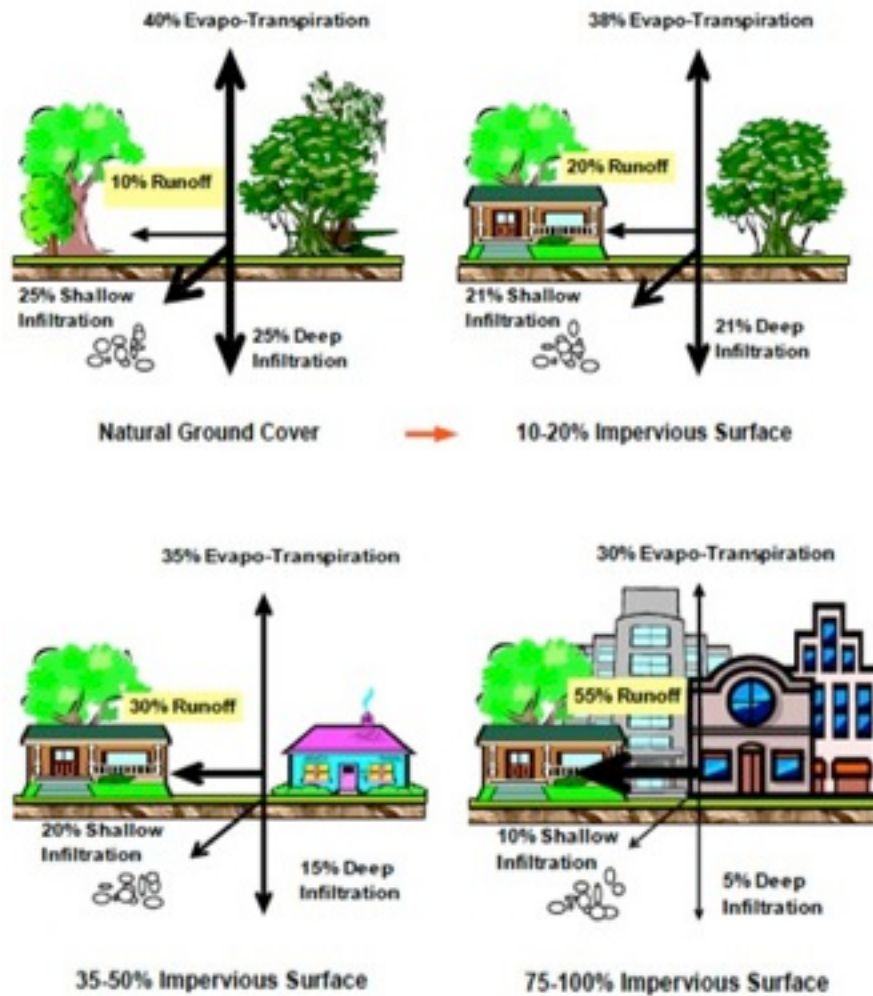

(Source: U.S. Environmental Protection Agency)

3.2.2. Stormwater Pollutants and Removal Processes

Urban development degrades water quality by accelerating [eutrophication](#) in surface waters receiving runoff and can increase nutrients in ground waters. The reduction in [pervious surface](#) and vegetation in the developed landscape removes natural filtration mechanisms and increases pollutant loads discharged into receiving waters. Fertilizers, pesticides, oils and greases, and other pollutants characteristic of urban land uses are flushed from the watershed during storms becoming trapped in stormwater and discharged into surface waters.

An understanding of the pollutants likely to be in stormwater, the processes needed to remove them, and the BMPs available to provide those processes can help ensure that effective stormwater treatment is provided. The most common pollutants in stormwater are sediment, nutrients (nitrogen and phosphorus), heavy metals (zinc, nickel, lead, chromium, cadmium, and copper), pathogenic bacteria, pesticides, and organic pollutants (gasoline and oils).

In Florida, excess nutrients are the greatest water quality issue facing our surface and ground waters. In fact, many water bodies are not meeting their water quality standards. The FDEP adopts [Total Maximum Daily Loads \(TMDLs\)](#) that set a watershed-based pollutant loading cap for these "[impaired waters](#)". This prevents new pollutant loadings to the water body and requires existing pollutant loading sources within the watershed to reduce their loadings. There are many sources of nutrients. Nutrients are applied to our farms, lawns and public landscaped spaces as fertilizers, and are discharged to the ground water from septic tanks. Nitrogen from atmospheric deposition and vehicular tailpipes is deposited on parking lots and roads and is then washed off by rainfall.

Phosphorus is often the growth limiting nutrient in surface water, so any increase in its concentration is likely to result in increased growth of algae and other plants. The clarity of the water is decreased. When algae die off, decomposing bacteria can deplete oxygen levels in the water, harming other aquatic life.

Native soils in north Florida often have very high levels of mineral phosphorus. Consequently, plants need little or no phosphorus from fertilizers. Any excess applied to our landscapes is carried away by runoff or infiltrated into the ground water, raising phosphorus levels in our water bodies. Phosphorus levels in soils can easily be determined by testing at local Cooperative Extension Service offices.

Phosphorus occurs in inorganic or organic forms, dominated by inorganic orthophosphates. In water, it can also be found in either dissolved or particulate form. Both inorganic and organic forms can be found as dissolved and suspended particulates. The particulates include phosphorus adsorbed to suspended sediment, organically bound particles, or phosphorus-precipitated aluminum, iron or calcium.

Accordingly, there are three primary mechanisms to remove phosphorus from stormwater.

- **Sedimentation:** The majority of phosphate is bound to particulates and can be mechanically removed by sedimentation and infiltration. The effectiveness depends on the particle sizes and densities.
- **Removal by plants:** Much of the small fraction of phosphorus that is naturally soluble is bioavailable. Additionally, some particulate-bound phosphorus can become bioavailable when broken down by bacteria. Long contact times in wet detention ponds and wetlands facilitate its removal from stormwater.
- **Precipitation from solution.** Soil or engineered media containing calcium, iron, or aluminum or cement can react to form a precipitate with phosphorus.

Theoretically, dissolved phosphorus can be removed by any BMP that employs vegetative growth or passage through appropriate soil or media while particulate phosphorus can be removed by sedimentation and infiltration. However, the amount removed varies considerably in stormwater treatment systems. One complication is that a large proportion of particulate phosphorus may be stored in sediment. Decomposing plant material can also release formerly dissolved phosphorus again into the water, and can cause treatment ponds and wetlands to eventually act as phosphorus source rather than a storage area. Periodic sediment removal and harvesting of plant growth is necessary to maintain long-term removal effectiveness.

The solubility of phosphorus is not a constant. The pH is an important factor, with 6.5 corresponding to maximum solubility. As pH increases more phosphorus precipitates with calcium, but aluminum and iron precipitates are more common in acidic soil. Higher pH levels correspond to decreased oxidation-reduction potential of suspended particles, further reducing their sorption capacity for phosphorus. Temperature changes and anaerobic conditions can also change removal effectiveness. Phosphorus removal is therefore highly variable, and can be site specific.

Nitrogen exists in several forms in the environment: ammonia (NH_3), nitrite (NO_2), nitrate (NO_3), or as nitrogen gas (N_2). Fertilizers and decomposing organic matter contain ammonia, which is broken down by microorganisms in the soil. If oxygen is available (aerobic conditions), ammonia will be converted to nitrite, and then into nitrate. This typically occurs in shallow water bodies as well as in very sandy soils. Nitrate is very soluble in water and is not removed by sedimentation or sorption mechanism, so excess nitrates can easily enter ground water.

Nitrates are harmless in naturally occurring amounts, but high levels can cause health problems for babies. They should not ingest water or infant formula made with water with $\text{NO}_3\text{-N}$ levels exceeding 10 mg/l. Few places have nitrates high enough to cause health concerns, but many of Florida's springs have increasing nitrates. In some springs $\text{NO}_3\text{-N}$ has increased from naturally occurring levels under 0.1 mg/l to more than 5 mg/l. While these levels are not likely to cause health concerns, they can cause spring water to become cloudy with increased plant growth and cause algal blooms in water bodies.



Low nitrate levels in ground water result in clear water

Abnormally high levels of nitrates can come from septic systems, municipal and agricultural wastewater, and overuse of fertilizers. Additionally, monitoring of septic tanks in several areas in Florida, along with recent monitoring of [stormwater retention systems](#) in Marion County, has demonstrated the importance of soil characteristics in and beneath drain fields and retention BMPs in reducing nitrate movement into the ground water.

Nitrate leaching into ground water can be lessened in two ways. Plants take in nitrate as a requirement for their growth, so it can be removed in any vegetated area. Obviously it is most effective where there is vigorous plant growth, such as in wetlands and enhanced stormwater ponds. However, if the resulting growth is not removed, it will release nutrients as it decomposes and the previously absorbed nitrogen will re-enter the water cycle.

The second way nitrate is removed is when the Nitrogen Cycle is promoted in the design of the retention system or septic tank. This is accomplished by ensuring the soil characteristics promote soil microbial mechanisms of Ammonification, Nitrification, and Denitrification. Key soil characteristics include infiltration rate, soil moisture, clay content, dissolved oxygen concentrations, and Cation Exchange Capacity. Fine-textured soils retain moisture, have a higher CEC, and reduce oxygen transport into the subsurface. The Karstic sandy soils typically found in springsheds do not have these types of soil characteristics leading to nitrate creation and movement into the ground water and springs. Soil amendments such as [Biosorption Activated Media \(BAM\)](#) can be used to create the proper soil conditions to promote the Nitrogen Cycle and reduce nitrate loads discharged from retention BMPs into the ground water.

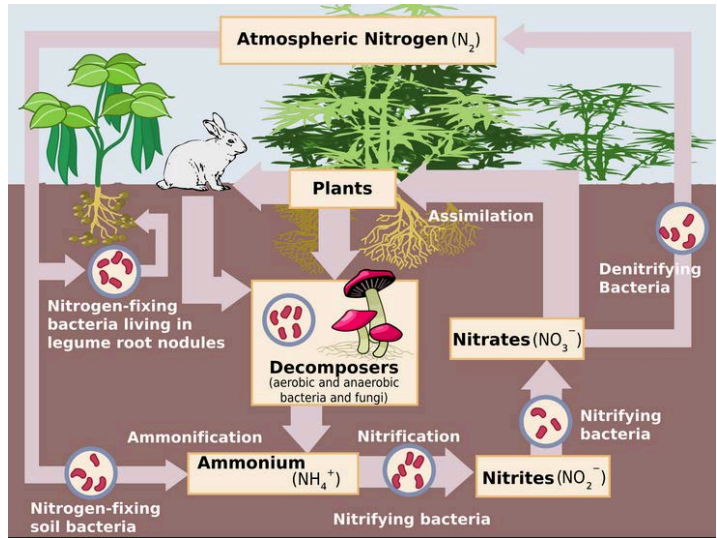

Metals – Stormwater is the source of 80-95% of heavy metals in Florida’s surface waters. Most of these: zinc, cadmium, copper and nickel enter stormwater from our cars from degradation of tires, engine parts and brake linings along with motor oils, grease, and other lubricants. They are deposited on roadways as they leak or wear down, and are washed off by stormwater. Insecticides and fungicides also may contain copper and cadmium. Many metals are particulate in nature and are effectively removed by sedimentation and settling. Other metals are in dissolved form and can be removed by wetland vegetation. Heavy metals can also be removed through sorption by filtering stormwater through certain types of vegetative mats with high lignin content, such as alfalfa or aspen fibers (Han, 1999)

Figure 3.3. The Nitrogen Cycle transforms nitrogen into nitrogen gas

Organic pollutants such as oil, gasoline, and other hydrocarbons have a high affinity for soil and mulches are usually removed and biodegraded during infiltration. Sunlight and bacteria in standing water bodies also can degrade hydrocarbons.

See [Section 4.2](#) for additional information on stormwater treatment fundamentals and mechanisms.

3.3. Goals of Stormwater Management

3.3.1. General goals of stormwater management

The ultimate stormwater management goal is to maintain the [predevelopment](#) stormwater characteristics of a site or watershed after development (Section 62-40.431(2), F.A.C.). More generally, the goals of stormwater management are to minimize the adverse effects of urban development on communities, watersheds, water bodies, wetlands, floodplains and other natural systems. These goals also should be applied to redevelopment situations so that existing stormwater conditions are appropriately improved with reconstruction. More specifically, these goals include:

1. Reducing pollutant concentrations and loadings as needed to ensure that discharges do not cause or contribute to violations of State water quality standards.
2. Preventing or reducing on-site and offsite flooding.
3. Maintaining or restoring the hydrologic integrity of wetlands and aquatic habitats.
4. Maintaining and promoting ground water recharge.
5. Minimizing erosion and sedimentation.
6. Promoting the reuse of rainfall and stormwater

3.3.2. Escambia County Comprehensive Plan - Stormwater Management Goals

The [Escambia County Comprehensive Plan](#) guides growth and development within the County through policy initiatives. The applicable Policies, Goals and Objectives of the Comprehensive Plan were used as the foundation to the purpose and intent of the Low Impact Design BMP Manual.

The goal of the Conservation Element of the Comprehensive Plan is to “ensure the protection of Escambia County’s natural resources”. Objectives and Policies in this section set forth requirements to “effectively manage the natural resources of Escambia County through sound conservation principles”. Additionally, surface water resource Objectives and Policies aim to “Protect and improve the quality, biological health, and natural function of all surface water systems to preserve their ecological and aesthetic values.” This includes “implementing the stormwater management policies of the Infrastructure Element to improve existing stormwater management systems and ensure the provision of stormwater management facilities concurrent with the demand for such facilities”. Finally, the Conservation Element includes Objectives and Policies that “require and encourage land development and landscaping practices that conserve, appropriately use, and protect native vegetation, and that maintain and enhance plant species diversity.” With regard to stormwater management, a Policy “recognizes that a healthy, diverse, and well-managed urban forest is an important public asset. The County will preserve, maintain, and support the urban forest, requiring the maximum practical preservation of existing native vegetation with all development.”

The Stormwater Management Component of the Comprehensive Plan’s Infrastructure Element objective is to “Ensure the safe and efficient provision of stormwater management through maximized use of existing facilities, maintenance of appropriate levels of service, correction of existing deficiencies, and protection of natural resources.” Stormwater Levels of Service are set in the [Escambia County Land Development Code](#) design standards and Policy prohibits the discharge of untreated stormwater.

3.4. Introduction to Stormwater Management

[Stormwater management systems](#) are required to mitigate the stormwater quantity and quality changes that accompany urban development. Stormwater treatment systems are those components of a stormwater management system used to control pollutant loads. The [Best Management Practices \(BMPs\)](#) used within stormwater treatment systems can be categorized into two basic categories:

(a) Nonstructural BMPs (AKA source controls). These BMPs are used for pollution prevention to minimize pollutants getting into stormwater or to minimize stormwater volume. They include Site Planning BMPs such as preserving vegetation, clustering development, or minimizing total imperviousness and directly connected impervious areas. They also include Source Control BMPs such as minimizing clearing, minimizing soil compaction and using

Florida-friendly landscapes and fertilizers. All of these nonstructural BMPs fall under the umbrella term known as “[Low Impact Design](#)” (LID) that are discussed later in this chapter.

(b) Structural BMPs. Structural BMPs are used to mitigate the changes in stormwater characteristics associated with land development and urbanization. There are three major types of structural BMPs: retention BMPs, detention BMPs, and filtration BMPs.

- [Retention BMPs](#) are infiltration-based practices – the stormwater treatment volume is not discharged directly to surface waters but is “retained onsite” through percolation into the soil, evaporation, and evapotranspiration. Infiltration BMPs include retention basins, exfiltration trenches, swales, rain gardens (bioretention), vegetated natural buffers, and pervious pavement.
- [Detention BMPs](#) are those that detain stormwater and discharge it offsite at a specified rate, usually the predevelopment peak discharge rate. The most common type of detention BMP in Florida is a wet detention system that has a permanent pool of water.
- Filtration BMPs typically are used with detention systems in which the discharge structures incorporate pollutant removal media, often a Biosorption Activated Media, within a filtration system. Filtration systems are more maintenance intensive and are generally used only in special circumstances where more traditional retention and detention BMPs do not achieve the stormwater treatment goals for a site or project.

[Table 5.1](#) lists the nonstructural and structural BMPs incorporated into this Manual. Each of the BMPs is discussed and described in more detail in [Section 5.1](#) (Site Planning BMPs), [Section 5.2](#) (Source Control BMPs), or [Sections 5.3](#) through 5.16 (Structural BMPs).

3.5. Introduction to Low Impact Design

3.5.1. What is “Low Impact Development” or “Low Impact Design” (LID)

LID is a stormwater and land use management strategy that strives to mimic pre-disturbance hydrologic processes of infiltration, filtration, storage, evaporation, and transpiration by emphasizing conservation, use of on-site natural features, improved site planning, and distributed stormwater management practices that are integrated into a project’s design, especially it’s landscaping and open space.

Low Impact Design (Development) (LID): An approach to land development that preserves and protects natural-resource systems using various site planning and design approaches and technologies to simultaneously conserve and protect natural resource systems while managing stormwater runoff. The approach includes using engineered small-scale hydrologic controls to replicate the pre-development hydrologic regime through infiltrating, filtering, storing, evaporating, harvesting, and detaining runoff close

The goals of LID stormwater management include:

1. **Achieve multiple objectives** – Comprehensive stormwater management helps achieve multiple objectives such as: managing peak discharge rates and total discharge volume; providing effective stormwater treatment to minimize pollutant loadings; maintaining or improving the hydrologic regime at a site; and retaining or harvesting stormwater onsite for non-potable purposes. LID also promotes integrating stormwater systems into the landscaping and open space of a site creating more attractive and diverse systems.

2. **Preserve or restore natural features and resources** – The conservation or restoration of natural features such as floodplains, soils, and vegetation helps to retain or restore hydrologic functions thereby achieving the multiple objectives above.
3. **Minimize soil compaction** – Soil compaction disturbs native soil structure, reduces infiltration rates, and limits root growth and plant survival.
4. **Reduce and disconnect impervious surfaces** – By minimizing [impervious surfaces](#), especially [directly connected impervious surfaces](#), more rainfall can infiltrate into the ground.
5. **Manage stormwater close to the source** - Using source controls to minimize the generation of stormwater or pollutants that can get into stormwater needs to be first step in managing stormwater.
6. **Use a [BMP Treatment Train](#) approach** – Effective stormwater management requires a comprehensive approach that incorporates source controls with multiple structural stormwater BMPs (retention, detention, and filtration) often integrated into the landscaping to create an efficient stormwater management system.

Successful adoption of LID stormwater management requires a fundamental shift in thinking from the traditional “collect, concentrate, convey, centralize and control” approach to a new stormwater management mantra of “retain, detain, recharge, filter and use”. Unlike conventional stormwater systems, which typically control and treat runoff using a single engineered stormwater BMP located at the “bottom of the hill,” LID systems are designed to promote volume attenuation and treatment at or near the source. LID systems use a suite of stormwater BMPs – Site Planning BMPs, Source Control BMPs, and Structural BMPs such as retention, detention, infiltration, treatment and harvesting mechanisms – that are integrated into a project site to function as a “BMP Treatment Train”.

LID practices facilitate on-site infiltration by applying practices that preserve [pervious surfaces](#), limit the total area of [impervious surfaces](#), and disconnect impervious surfaces. The following site design objectives are key to achieving the County’s stormwater hydrology and pollutant load reduction goals:

- A. Conservation Measures - Preserve or conserve existing site features and assets that facilitate natural hydrologic function.
 - Maximize retention and protection of native forest cover, vegetation and wetlands and replant trees and other vegetation to intercept, evaporate, and transpire precipitation.
 - Preserve permeable, native soil, and enhance disturbed soils to store and infiltrate stormwater.
 - Retain and incorporate topographic site features that slow, store, and infiltrate stormwater.
 - Retain and incorporate natural stormwater management features and patterns.
 - Minimize site disturbance and compaction of soils through low-impact clearing, grading, and construction measures.
- B. Site Planning and Minimization Techniques - Minimize generation of runoff and pollutants from your project as close to the source as possible
 - Use a multidisciplinary approach that includes planners, engineers, landscape architects, and architects at the initial phases of the project.
 - Locate buildings away from critical areas and soils that provide effective infiltration.
 - Reduce hard surfaces, total impervious surface area, minimize directly connected impervious areas, increase retention of native vegetation, and plant native trees.
- C. Distributed and Integrated Management Practices
 - Manage stormwater as close to its origin as possible by using small scale, distributed hydrologic controls.

- Create a hydrologically rough landscape that slows storm flows.
 - Increase reliability of the stormwater management system by providing multiple or redundant LID flow control practices.
 - Integrate stormwater controls into the development design and use the controls as amenities to create a multifunctional landscape.
 - Reduce the reliance on traditional conveyance and pond technologies.
- D. Low Impact Construction Techniques - Clearing, grading, and construction measures that minimize site disturbance and promote LID function include:
- Minimizing the amount of area cleared.
 - Clearing selectively to protect trees and other vegetation.
 - Using smaller and lighter construction equipment where possible.
 - Keeping heavy equipment outside of the drip line of preserved trees.
 - Minimizing grading and importing of fill (e.g., through use of stemwall construction).
 - Keeping heavy equipment off soils where infiltration-dependent stormwater practices will be used.
 - Designating storage areas for construction equipment and materials
- E. Maintenance and Education
- Develop reliable and long-term maintenance programs to provide clear and enforceable standards.
 - Educate owners of LID projects, landscape management professionals, and other interested parties on the operation and maintenance of LID systems.
 - Protect LID systems by promoting community participation.

A fundamental premise of LID is that the more closely an engineered stormwater system mimics a site's predevelopment hydrologic characteristics, the better it will perform in terms of meeting both flood control and stormwater treatment goals for the project. This means LID projects should strive to have the same conditions (or better, if a site has already been degraded) for total stormwater runoff volumes, peak discharge rates, runoff conveyance patterns, and infiltration and treatment capacity as were present before development. LID project designs typically employ a combination of innovative, conventional, non-structural and structural engineered designs to accomplish these goals. Note that although LID techniques are often decentralized within a particular site or parcel, they are not disconnected but are integrated into a BMP Treatment Train.

Typically, LID practices will not completely replace more conventional "bottom-of-the-hill" stormwater management practices, but can be used to complement these practices and to ensure that the entire stormwater management system meets the Escambia County water resources objectives. **Combining conventional and LID stormwater management practices can reduce the area devoted solely to stormwater management and allow more efficient use of the development site.**

3.5.2. Advantages of LID

Why might LID – from a single BMP to an LID master plan – be considered a superior alternative to conventional design? Quite simply, it depends on the interests of the party or person posing the question, but the evidence from a growing field of LID practice suggests that with the essential ingredients of early planning, commitment, and creativity, LID strategies can lead to net benefits for all parties involved.

For the developer, the LID reward might be a direct monetary benefit from avoided investments in stormwater infrastructure – or a lot gained via clustering and LID stormwater management with native hydrologic conditions in mind. For local governments and the general public, the LID

reward might be the benefit of protected or enhanced water quality and reduced stress on natural resources that sustain local economies. For the homeowner, the LID reward might be improved property values. Integrating LID strategies as standards of practice in development projects will take time, energy and commitment on the part of developers, builders, county staff, and homeowners, yet the diversity of economic, environmental and social benefits that LID strategies have to offer make them a critical piece of the overall stormwater management strategy in Escambia County.

Despite concern that the assumed or perceived financial costs associated with using LID in [redevelopment](#) projects will drive developers to [greenfield development](#), encouraging sprawl and exacerbating water quality problems, experience is proving that developers are pursuing (and having success with) LID projects in both redevelopment and greenfield projects. Not only are developers with experience in LID continuing to invest in projects in their standard markets despite increasingly strict stormwater standards, but they also are finding that LID can reduce their costs relative to conventional stormwater controls (EcoNorthwest, 2011). The most commonly cited area of cost savings/revenue gains for developers choosing LID over conventional design is in stormwater piping and road infrastructure (conveyance pipes, etc.), landscape investments (e.g., sod area, in-ground irrigation systems), and developable lots (e.g., via clustering and distributed stormwater conveyance and treatment controls, reducing the size of the stormwater pond necessary for treatment.)

In a 2009 article in Land Development magazine, landscape architect and University of Florida faculty member Glenn Acomb describes the LID experience in Madera, a 44-acre, 80-lot residential subdivision in the City of Gainesville, Florida. Preservation of existing hydrology, topography and tree canopy were critical elements of the site design. By taking advantage of existing contours of the site to capture and infiltrate stormwater, the site plan resulted in on-site control of the majority (70%) of the site's stormwater runoff. Furthermore, this design saved the developer \$40,000 in stormwater infrastructure costs (U.S. HUD, 2005). At the lot level, particularly for the development's model home, resource-efficient, LID strategies were integrated to the maximum extent possible, from Energy Star certification to Florida-Friendly landscaping, to shared driveways. Comparing Madera "LID" lots to conventional lots, Acomb reports a 7.6% savings in capital costs (~\$1,500 per lot to the developer) and estimates ~\$1,900 in annual savings per lot for landscape maintenance (to the homeowner) for the Madera lots (Acomb, 2004). Pre-development conditions made the site particularly favorable for implementing a broad suite of LID strategies, but nevertheless, Madera serves as a model example of LID in new residential development in Alachua County.

Not all monetary costs/benefits of LID stormwater management fall to the developer, however. Occupants of buildings with green roofs, for example, are expected to realize significant energy savings (i.e., reduced operational costs) over the life of the project. Homeowners with rain gardens or lots adjacent to ecologically enhanced stormwater ponds may benefit from increased market value of their homes (particularly as the consumer market for native, low-maintenance landscapes continue to grow.)

ECONorthwest (2011) provides a detailed report on the factors influencing developers' decisions to pursue LID projects, profiling three of the most progressive regions of the U.S. with respect to LID (Montgomery County, MD; Philadelphia, PA; Olympia, WA). Their results indicate a significant (albeit gradual) shift occurring in the market for LID in both redevelopment and greenfield projects. The report highlights the need for creativity and flexibility on the part of the development team in order to realize the significant economic, environmental and social benefits that LID approaches offer. The full report is available at: http://doee.dc.gov/sites/default/files/dc/sites/ddoe/publication/attachments/ECONW_Final_Report_2011-0628.pdf

For a comparison of traditional and LID development techniques along with a tool to conduct a cost-benefit analysis for your site, consult the Green Values National Stormwater Calculator at <http://greenvalues.cnt.org/national/calculator.php>. In addition, the BMPTRAINS Model Version 8 released in August 2016 includes an ability to calculate BMP costs.

Environmental and ecological rewards from LID include water quality protection/pollution prevention, protection of drinking water supplies via enhanced infiltration and treatment of stormwater runoff, and wildlife and habitat protection and provision.

Many LID applications are valued as social or community amenities. Roadway and median swale/tree box/green street applications often calm traffic (improving public safety) and reduce heat-island effects in urban environments. Mixed-use, clustered communities reduce the need for lengthy commutes from home to work or play (which also translates to a monetary benefit for residents). While difficult to value directly, the aesthetics of LID stormwater features also provide a public amenity.

3.6. Site Planning and Design

To effectively use and integrate LID BMPs into a [stormwater management system](#) requires sites to be evaluated for LID compatibility as early as possible in the planning process. Specific site conditions must be carefully evaluated to determine LID feasibility and to design and construct each LID practice. This manual supports Escambia County's goal of applying the LID concept and design where feasible to enhance existing stormwater management measures and reduce the adverse impacts of land development projects on the County's natural resources.

Assessing a site's natural stormwater management capabilities and resources is a necessary step toward integrating them into the stormwater management system. The site assessment process provides information about current conditions that are essential to implement the site planning and layout activities. Specifically, site assessment should evaluate hydrology, topography, geology, soils, vegetation, wetlands, and water features to identify how stormwater moves through the site before and after development or redevelopment. Projects should be designed and constructed with the objective of preserving and using on-site features to help manage stormwater.

Key site assessment factors that are directly related to the type and design of a BMP Treatment Train for a particular site include:

- What natural features (tree canopy, vegetation, depressions, etc.) intercept and/or capture rain as it falls on the site and return portions of it to the atmosphere via infiltration, evaporation and/or transpiration?
- What is the topography of the site and does it promote stormwater drainage away from the site or capture and infiltrate stormwater on site?
- Is the site adjacent to a water body or wetlands and does it have any buffer or riparian zones?
- What are the hydrologic soil groups and distributions on-site, and to what extent do they promote infiltration of rainfall (i.e., what are their infiltration rates)? Is there a "hard pan" in lower soil levels that inhibits infiltration?
- Where and to what extent have soils been modified, disturbed and/or compacted, reducing infiltration rates and promoting runoff generation?
- What is the elevation of the [SHGWT](#) throughout the site and when and how long does it occur?

- Do critical and sensitive areas (wetlands, riparian areas, etc.) that provide capture, uptake, and filtering of pollutants exist on site and have they been protected or disturbed?
- What physical structures (buildings, parking lots, etc.) intercept rainfall and convey it as stormwater to other areas of the site and/or away from the site?
- What [pervious surfaces](#) (natural and structural) allow stormwater to infiltrate to parent soils?
- What [impervious surfaces](#) (natural and structural) prevent infiltration of stormwater and promote runoff?
- What engineered stormwater treatment systems exist on site and could they be enhanced or retrofitted to improve performance?

A first step in evaluating sites for LID opportunities is to review the Site Planning BMPs and the Source Control BMPs in [Table 5.1](#). Several of these LID BMPs provide direct or indirect stormwater pollutant load reduction credits. Next, complete the Environmental Resources Assessment Checklist (Figure 3.4) to ensure a thorough assessment of environmental conditions on the site.

The items on the Environmental Resources Assessment Checklist can help designers choose appropriate BMPs that protect important resources. For example, in high aquifer recharge areas, infiltration-based BMPs such as retention basins, rain gardens, and permeable pavement systems should always be considered, but the topography of the site (e.g., steep slopes) might constrain their design. For projects in wellfield protection areas or those where spills of hazardous materials are possible, source control of stormwater pollutant loads is an especially important consideration. Also, infiltration-based treatment BMPs must be designed to avoid inadvertent transfer of contaminants from surface water to ground water.

The Environmental Resources Assessment Checklist is also intended to ensure LID BMPs and strategies are considered at the beginning of the project design. They should never be an afterthought or simple “add-on” to a conventional design. Mechanisms to reduce site disturbance before, during, and after construction are one of the most critical elements of an integrated and effective approach to LID stormwater planning. Opportunities to preserve and promote natural hydrologic functioning of a site are often lost as a result of conventional development practices such as non-selective site clearing, export of native soils, importing of fill, mass grading, and construction in sensitive areas using heavy machinery. Compacting soils reduces the pore space available for storage and infiltration of stormwater.

Rather than defining the project goals, designing the stormwater system to meet those goals, and then trying to fit LID BMPs into the project, developers and project engineers are encouraged to first define the project goals to be consistent with using LID BMPs. Next, plan the entire site and design the entire stormwater management system to use as many LID principles and BMPs as possible. LID BMPs work well at both the subdivision level and on individual lots as seen in Figures 3.5 and 3.6.

Project planners and design engineers should consider stormwater an asset that can be used to reduce the impact of development projects on water resources. Rather than designing systems to drain stormwater from the site, LID promotes retention, treatment and harvesting of stormwater on-site. To encourage the practice of using stormwater as an asset, Escambia County has included incentives within its [Land Development Code](#) that allow open space and landscaping requirements to be satisfied through LID stormwater management techniques.

Remember, stormwater is a valuable freshwater resource that can be captured and used for a variety of non-potable purposes. Cisterns or rain barrels can be used for collecting, storing, and using rainwater for irrigating lawns and landscape beds, irrigating green roofs, washing vehicles, and toilet flushing as approved by state and Escambia County health codes. [Detention systems](#)

can incorporate “stormwater harvesting” to reduce stormwater volume and pollutant loading discharges and save valuable freshwater for landscape irrigation or non-potable purposes.

Figure 3.4. Environmental Resources Assessment Checklist

Use this Checklist to conduct an inventory to compile site-specific identification, analysis and mapping of each resource present on or adjacent to the project site. The identification and analysis shall indicate information sources consulted.

Natural Resources Checklist:

Check "Yes" for each resource or resource characteristic identified and discuss and provide supporting material.

Check "NA" for each resource or resource characteristic not present or otherwise relevant to the proposed project.

YES		NA		Surface waters (lakes, stream, springs, sinkholes, etc.)
YES		NA		Outstanding Florida Waters or Impaired Water Bodies
YES		NA		Wetlands
YES		NA		Floodplains or High Hazard Flood Areas (100 year)
YES		NA		Special Overlay Districts
YES		NA		Threatened or Endangered Species or their Habitats
YES		NA		Topography/Steep Slopes
YES		NA		Soil Types including Hydrologic Soil Groups and Seasonally High Ground Water Tables
YES		NA		Urban Forests, Heritage Trees, or Protected Trees
YES		NA		Recreation/Conservation/Preservation Lands
YES		NA		Historical or Paleontological Resources
YES		NA		Wellfield Protection Areas or Wells
YES		NA		High Aquifer Recharge Areas
YES		NA		Hazardous Material Storage Facilities
YES		NA		Contamination (soil, surface or ground water)

Signed: _____

Project Name: _____

Date: _____

Figure 3.5. Stormwater LID BMPS at the Lot Scale

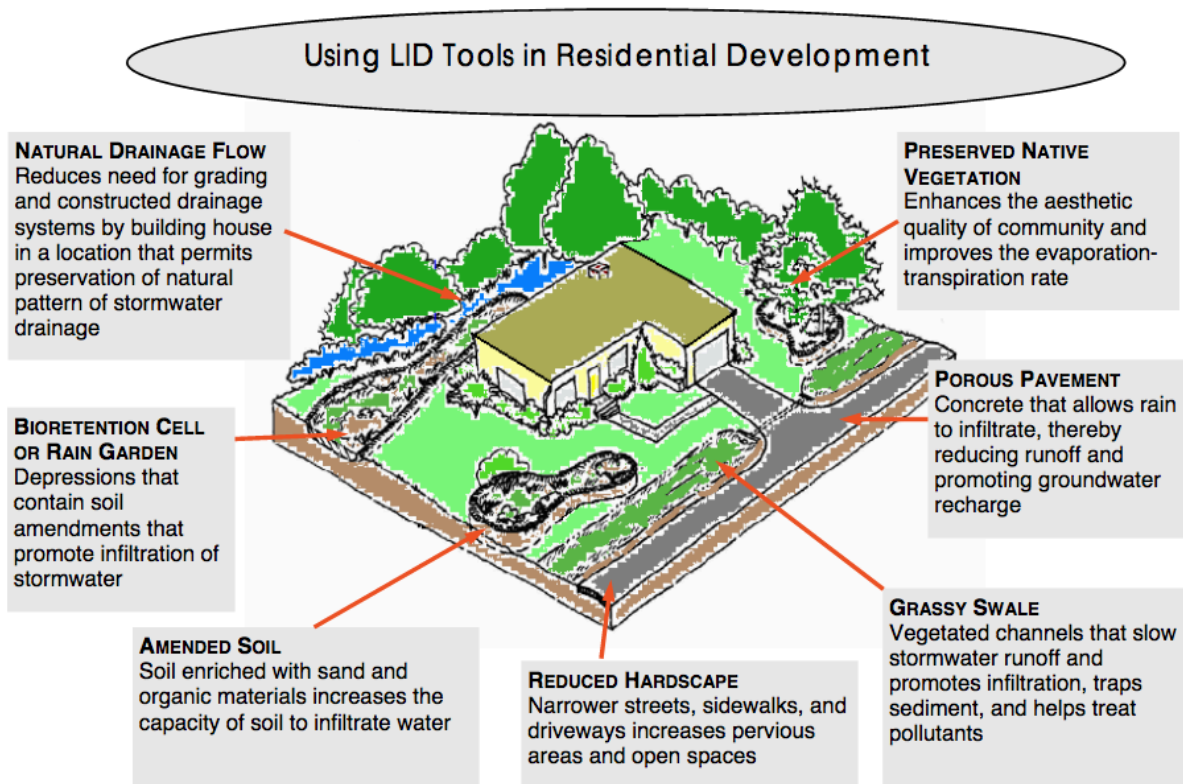

Diagram adapted from Prince George's County Maryland Low-Impact Development Design Strategies

Figure 3.6. Stormwater LIDs at the Lot Scale (Medera Model Home)



Source: Dr. Glenn Acomb, PREC Photo Library

Table 3.1 summarizes the functional aspects of LID BMPs and the optimum timing during the site planning and construction process for their consideration. This information can be used together with the Stormwater BMP Checklist (Table 5.1) to facilitate the design of BMP Treatment Trains that incorporate LID strategies and BMPs. The BMP checklist is separated into three “phases” roughly parallel to key phases of land development and stormwater planning: conceptual site planning BMPs, source control BMPs, and stormwater BMPs.

Table 3.1. Functional Aspects and Timing of LID BMPs

LID technique	Emphasized functional aspects					Occurrence during construction
	Infiltration	Runoff minimization	Runoff reuse	Water quality improvement	Reduced maintenance & water usage	
Amending disturbed or compacted soil						Late
Permeable pavement or paving often with under-pavement storage						Middle
Grassy or vegetated swales on uncompacted soil (often with curb elimination or curb cuts)						Early to Middle
Dry wells or exfiltration tanks						Middle
Bioretention (rain garden)						Middle to Late
Tree boxes and tree filters						Middle to Late
Vegetated Natural Buffers (VNB)						Early
Tree canopy retention and drip line root protection						Very Early
Neighborhood design						Very Early
Reducing Directly Connected Impervious Areas (DCIA)						Early
Green roofs (vegetated roofs)						Middle
Minimization of site disturbance and/or construction footprint						Early
Cisterns and rain barrels						Middle to Late
Stormwater reuse ponds						Middle to Late
Florida-friendly Landscaping						Late
Drip irrigation						Late

3.7. References Cited

1. James Han. 1999. Stormwater Filtration of Toxic Heavy Metal Ions Using Lignocellulosic Materials Selection Process, Fiberization, chemical Modification, and Mat Formation, US Department of Agriculture, Forest Service, <http://www.treesearch.fs.fed.us/pubs/5758>
2. ECONorthwest. June 2011. Economic Factors that Influence Developers' Decisions. http://doee.dc.gov/sites/default/files/dc/sites/ddoe/publication/attachments/ECONW_Final_Report_2011-0628.pdf

3. U.S. Department of Housing and Urban Development – Partnership for Advancing Technology in Housing (PATH). Low-Impact Development in the Madera Community, Gainesville, Florida. Case Study, August 2005. Accessible at <http://www.swinter.com/services/documents/MaderaCaseStudy.pdf>.
4. Glenn Acomb. LID vs. Conventional Site Design: The Madera Case Study. *Land Development*. Fall 2009, 22-27.

CHAPTER 4 – EVALUATING STORMWATER TREATMENT EFFECTIVENESS

4.1. Introduction

This chapter provides additional information on stormwater treatment processes and how they can be integrated into an effective BMP Treatment Train using Low Impact Design BMPs. Emphasis is placed on selecting BMPs that are complementary and not duplicative with respect to stormwater pollutant reduction processes. The performance standards establishing the minimum level of stormwater treatment are summarized. This includes the “Net Improvement” performance standard for waters within Escambia County and Florida that are not meeting applicable water quality standards (impaired waters). Accordingly, the chapter walks users through calculating pre-development and post-development stormwater pollutant loadings. Finally, computational aids to assist with these calculations are discussed.

4.2. Stormwater Treatment Processes

Stormwater pollutant loading is a product of the stormwater volume discharged off-site times the [Event Mean Concentration \(EMC\)](#) of the pollutant(s) of interest. **Therefore, to reduce stormwater pollutant loading, one can reduce stormwater volume or stormwater concentration or both.** However, as seen in [Table 4.4](#), the stormwater pollutant concentrations are relatively low, especially when compared to the concentrations of pollutants in wastewater. Typically, stormwater pollutant concentrations are similar to wastewater that has been treated to Advanced Wastewater Treatment standards. Therefore, in general, **the greatest stormwater pollutant load reduction potential is associated with reducing the volume of stormwater discharged off-site.**

However, many BMPs, including source controls, incorporate mechanisms that also reduce stormwater pollutant concentrations. To design BMPs to effectively treat stormwater, it is helpful to understand the basic processes involved and why they remove pollutants. Figure 4.1 illustrates the effect of pollutant particle size on the relative volume of water that can be treated. It also lists groups of BMPs and a range over which each one functions. Following it, Table 4.1 breaks down the basic treatment processes, the BMPs that employ them and what they remove.

Choose treatment BMPs based on the hydraulic loading rate, the expected or measured stormwater pollutants, the type of soil present, the level of treatment required, and the cost. One problem preventing wider use of LID treatment has been missing or inconsistent data on the effectiveness of stormwater BMPs on various pollutants. However, between 1999 and 2013, FDEP funded numerous projects to monitor the effectiveness of regular and LID BMPs. The results of these projects were used to develop the LID BMP Design Criteria in this Manual. One of these projects was the Escambia County Central Office Complex. Links to web sites with many of the LID BMP completed research reports are on the [Acknowledgements](#) page of this Manual.

Additionally, [Harper and Baker \(2007\)](#) summarize information about BMP effectiveness based on monitoring done in Florida.

Figure 4.1. Stormwater Treatment Tradeoff – Particle Size vs. Hydraulic Loading

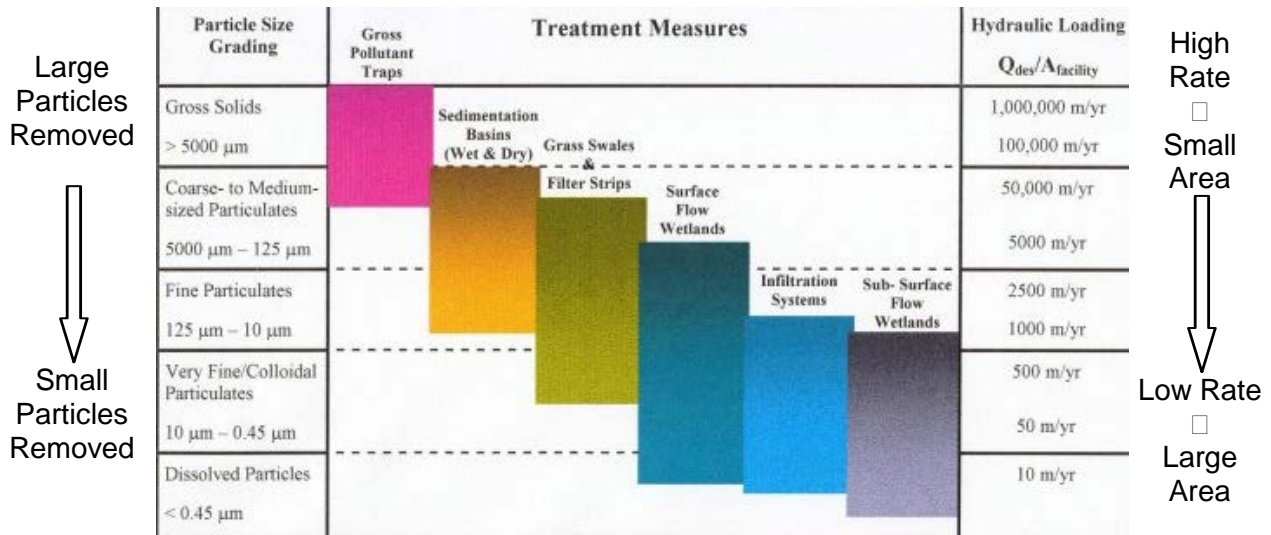

Table 4.1. Basic Mechanisms of Stormwater Treatment

Treatment Process	BMP Options	What is Removed?	How Does it Happen?
Flotation	Skimmers, oil/water separators, density separators	Oil and other hydrocarbons Trash	Substances lighter than water are removed with units specifically designed for this purpose.
Settling/Sedimentation	Bioretention wetlands, wet or dry ponds, tree boxes, cisterns	Suspended solids, Metals, Particulate phosphorus, Organics	Suspended particles settle by gravity, along with pollutants adhered to them. Forebays must capture and facilitate periodic removal of sediment. Avoid re-suspension of sediment.
Filtration	Sand/gravel filters, natural/amended soil, green roofs, infiltration tanks, horizontal wells.	Suspended solids Metals Phosphorus Organics	Stormwater passes through a porous material, mechanically removing anything larger than the pore openings.
Sorption (adsorption/absorption/ion exchange)	Any BMP employing infiltration through soils or other media, especially organic material or clay.	Dissolved nutrients Metals Bacteria	Contaminants adhere to irregularities in the surface of vegetation, to clay particles in soil or are attached to other molecules by chemical bonds.
Biological Removal	Bioretention, enhanced ponds, floating islands	Nitrogen, Phosphorus, Organic molecules	Microorganisms and plants take in nutrients needed for their cell growth and break apart large organic molecules.

Treatment Process	BMP Options	What is Removed?	How Does it Happen?
Infiltration	Bioretention areas, retention ponds, wetlands, swales, tree boxes, infiltration tanks.	Suspended solids, Metals, Particulate phosphorus, Organics	As water moves from the surface into soil voids, contaminants are removed by a combination of filtration, sorption to soil and biological removal.
Degradation in open water	Wetlands and ponds with open water	Organic molecules	Some volatile compounds move into the atmosphere, and sunlight photolysis can break apart others.
Hydrodynamic Separation	Various commercial devices	Light hydrocarbons and trash Sediment and attached pollutants	The internal structure of the device may use a skimmer to remove things lighter than water, and it may create a vortex and/or a stilling basin to separate heavier sediment.
Chemical Precipitation	Cisterns or other stormwater storage before reuse.	Fine suspended solids Metals Organics	Chemicals such as alum attract small particles to charged ions, creating larger particles that can be removed by sedimentation. Not common unless stormwater is being treated for reuse.

4.3. Stormwater Treatment Performance Standards

As discussed in more depth in [Chapter 6](#), Florida’s Environmental Resource Permitting program is based on minimum levels of stormwater treatment (the Performance Standard) and BMP design criteria that are presumed to achieve the desired level of load reduction. The Performance Standard will vary with the type of receiving water body. The performance standards include:

1. Discharges to Surface Waters - Reduce the post-development annual average stormwater total nitrogen and total phosphorus load by at least 80%.
2. Projects that directly discharge to Outstanding Florida Waters – Reduce the post-development annual average total nitrogen and total phosphorus load by at least 95%.
3. Projects within watersheds of Verified Impaired Water Bodies or Water Bodies with Adopted Total Maximum Daily Loads (TMDLs) – Meet the “Net Improvement” performance standard discussed in Section 4.3.1 below.

4.3.1. Projects within Watersheds of Impaired Water Bodies or Water Bodies with Adopted Total Maximum Daily Loads (TMDLs)

[Section 373.414\(1\)\(B\)3](#), F.S., establishes the “Net Improvement” stormwater treatment performance standard. It states:

“If the applicant is unable to meet water quality standards because existing ambient water quality does not meet standards, the governing board or the department shall consider mitigation measures proposed by or acceptable to the applicant that cause net improvement of

the water quality in the receiving body of water for those parameters which do not meet standards”.

The DEP and the WMDs interpret this to mean that the post-development average annual stormwater pollutant loading must be less than the pre-development loading for the pollutant(s) of concern.

When is a project required to meet the “Net Improvement” performance standard? When the project’s stormwater discharge will contribute pollutant loadings to an impaired water body, a water body with an adopted TMDL, or a water body with an adopted BMAP. To see if this applies to a specific project, discuss this with the permitting staff during a pre-application meeting. Net improvement may be required if a project is located within:

- The “sub-watershed” of a water body that is not meeting its applicable water quality standards, as defined by the 12-digit Hydrologic Unit Code.
- The boundary of a WBID that is on the Verified List of Impaired Waters or for which a TMDL has been adopted.
- The WBIDs within the area covered by an adopted BMAP.

This level of treatment also applies to water bodies with adopted TMDLs. To determine if your project is within the HUC 12 sub-watershed or a WBID, use DEP’s Map Direct System at: <http://ca.dep.state.fl.us/mapdirect/?focus=tmdlvi>

4.3.2. Presumptive Criteria

Requirements established in this Manual for stormwater treatment BMPs are based on design criteria that are presumed to meet or exceed the performance standards discussed above and NFWMD and County goals and objectives. For the purposes of this manual, BMP effectiveness is based on removal of nutrients (total nitrogen and total phosphorus). It is presumed that stormwater management systems designed to achieve adequate treatment efficiencies for nutrients will adequately treat other pollutants that could otherwise cause or contribute to water quality violations. A presumptive approach generally means systems that comply with NFWMD and County BMP Design Criteria provide reasonable assurance that water resources are not harmed without requiring monitoring or substantial amounts of site-specific information. The presumption is rebuttable however, by either the applicant or the County, if site-specific information exists that indicates County goals and objectives will not be met unless additional or alternative measures are taken. The LID BMP design criteria in this Manual are presumptive criteria. They are based on the latest Florida BMP monitoring information. However, since they are not included in current ERP Applicant Handbooks, some of the LID BMPs must be permitted as alternative designs as discussed in [Chapter 6](#).

4.3.3. Criteria Flexibility and Alternative Designs

Innovative approaches to stormwater management are encouraged to ensure concurrent control of erosion, sedimentation, flooding, and water. A site designer/engineer may propose alternative designs to the stormwater BMP design criteria provided in this Manual. Alternative designs will be considered by the County in determining whether, based on plans, storm and load monitoring data, test results, or other information, that the alternative design is suitable for the specific site conditions, and provides equivalent water quality treatment to that required by the performance standards in this Manual. In otherwise determining whether reasonable assurance has been provided for compliance with this paragraph, the County Engineer shall consider:

- Whether the proposed system will provide the level of attenuation, storage and treatment required by the [Escambia County Land Development Code](#); and

- Whether reasonable provisions have been made to ensure that the system will be effectively operated and maintained.

4.4. Calculating Stormwater Pollutant Loading

A methodology for calculating site-specific annual average stormwater pollutant loadings is provided in this Section. The methodology is based on the one set forth in Harper and Baker (2007).

4.4.1. Calculation of Pre-Development and Post-Development Hydrology

To calculate hydrology and pollutant loading from the proposed project, develop a table similar to Table 4.2 to summarize land use information. Determine the [pre-development](#) and [post-development](#) characteristics of each of the individual watersheds or drainage basins at the project site. The Directly Connected Impervious Area (DCIA) consists of those [impervious areas](#) that are directly connected to the stormwater conveyance system. Impervious areas also are considered to be DCIA if stormwater from the area occurs as concentrated shallow flow over a short pervious area such as grass or a swale. **Non-directly connected impervious areas include all pervious areas and portions of impervious areas that flow over at least 10 feet of pervious areas with HSG A or B soils and over at least 20 feet of pervious area for other soil types.** The [Curve Numbers](#) are those in TR55 (NRCS, 1986).

Table 4.2. Example Land Use Categories Matrix to Calculate Loadings

Land Use	Total area	Non-DCIA CN	DCIA percentage
Pre-development			
Low Density Residential			
Single Family			
Multi-Family			
Low Intensity Commercial			
High Intensity Commercial			
Light Industrial			
Highway			
Natural Vegetated Community			
Post-development			
Low Density Residential			
Single Family			
Multi-Family			
Low Intensity Commercial			
High Intensity Commercial			
Light Industrial			
Highway			

Land Use	Total area	Non-DCIA CN	DCIA percentage
Natural Vegetated Community			

As noted in Section 2.3.1, Escambia County is in Rainfall Zone 1 and annually receives between 62 to 66 inches of rain (Figure 4.2). Table 4.3 provides tabular solutions to a series of calculations for determining annual runoff volumes in Precipitation Zone 1. When calculating annual average pollutant loadings use a rainfall volume of 62.5".

Figure 4.2. Annual Rainfall Isopleths in Escambia County



Source: Harper and Baker, ERD, June 2007

Table 4.3 below summarizes the calculated mean annual runoff coefficients (“C value”) as a function of curve number (CN) and Directly Connected Impervious Area (DCIA) in Precipitation Zone 1. These values reflect the average long-term runoff coefficients (C Values) over a wide range of DCIA and curve number combinations.

Table 4.3. Annual Runoff Coefficients (C Values) as a Function of DCIA Percentage and Non-DCIA Curve Number (CN)

Source: Harper and Baker, ERD, June 2007

NDCIA CN	Percent DCIA																				
	0	5	10	15	20	25	30	35	40	45	50	55	60	65	70	75	80	85	90	95	100
30	0.006	0.048	0.090	0.132	0.175	0.217	0.259	0.301	0.343	0.386	0.428	0.470	0.512	0.554	0.596	0.639	0.681	0.723	0.765	0.807	0.849
35	0.009	0.051	0.093	0.135	0.177	0.219	0.261	0.303	0.345	0.387	0.429	0.471	0.513	0.555	0.597	0.639	0.681	0.723	0.765	0.807	0.849
40	0.014	0.056	0.098	0.139	0.181	0.223	0.265	0.307	0.348	0.390	0.432	0.474	0.515	0.557	0.599	0.641	0.682	0.724	0.766	0.808	0.849
45	0.020	0.062	0.103	0.145	0.186	0.228	0.269	0.311	0.352	0.394	0.435	0.476	0.518	0.559	0.601	0.642	0.684	0.725	0.767	0.808	0.849
50	0.029	0.070	0.111	0.152	0.193	0.264	0.275	0.316	0.357	0.398	0.439	0.480	0.521	0.562	0.603	0.644	0.685	0.726	0.767	0.808	0.849
55	0.039	0.079	0.120	0.161	0.201	0.242	0.282	0.323	0.363	0.404	0.444	0.485	0.525	0.566	0.606	0.647	0.687	0.728	0.768	0.809	0.849
60	0.052	0.092	0.132	0.172	0.212	0.252	0.291	0.331	0.371	0.411	0.451	0.491	0.531	0.570	0.610	0.650	0.690	0.730	0.770	0.810	0.849
65	0.069	0.108	0.147	0.186	0.225	0.264	0.303	0.342	0.381	0.420	0.459	0.498	0.537	0.576	0.615	0.654	0.693	0.732	0.771	0.810	0.849
70	0.092	0.130	0.167	0.205	0.243	0.281	0.319	0.357	0.395	0.433	0.471	0.508	0.546	0.584	0.622	0.660	0.698	0.736	0.774	0.812	0.849
75	0.121	0.158	0.194	0.230	0.267	0.303	0.340	0.376	0.412	0.449	0.485	0.522	0.558	0.595	0.631	0.667	0.704	0.740	0.777	0.813	0.849
80	0.162	0.196	0.230	0.265	0.299	0.334	0.368	0.402	0.437	0.471	0.506	0.540	0.574	0.609	0.643	0.678	0.712	0.746	0.781	0.815	0.849
85	0.220	0.252	0.283	0.315	0.346	0.378	0.409	0.441	0.472	0.503	0.535	0.566	0.598	0.629	0.661	0.692	0.724	0.755	0.787	0.818	0.849
90	0.312	0.339	0.366	0.393	0.419	0.446	0.473	0.500	0.527	0.554	0.581	0.608	0.634	0.661	0.688	0.715	0.742	0.769	0.796	0.823	0.849
95	0.478	0.496	0.515	0.533	0.552	0.571	0.589	0.608	0.626	0.645	0.664	0.682	0.701	0.719	0.738	0.757	0.775	0.794	0.812	0.831	0.849
98	0.656	0.666	0.676	0.685	0.695	0.705	0.714	0.724	0.734	0.743	0.753	0.763	0.772	0.782	0.792	0.801	0.811	0.821	0.830	0.840	0.849

The information contained in Table 4.2 and Table 4.3 is used to estimate the annual runoff volume for a given parcel under either pre- or post-development conditions. The mean annual rainfall depth (62.5”) is multiplied by the appropriate mean annual runoff coefficient (C value) based upon the DCIA and curve number characteristics of the site as follows:

Equation 4.4.1 Annual Runoff Volume (ac-ft.) =

$$Area \text{ (acres)} \times Mean \text{ Annual Rainfall (inches)} \times C \text{ Value} \times \frac{1 \text{ ft}}{12 \text{ in}}$$

Linear interpolation can be used to estimate annual runoff coefficients for combinations of DCIA and curve numbers that fall between the values in the Table. For “naturally occurring” undeveloped conditions, it should be assumed that the percent DCIA is equal to 0.0.

4.4.2. Calculation of Pre-Development (Current) Stormwater Pollutant Loading

To calculate the pre-development annual mass loadings of total phosphorus and total nitrogen, multiply the pre-development annual runoff volume (derived in Section 4.4.1) by the land use specific runoff characterization data (event mean concentrations or EMCs) for total phosphorus and total nitrogen. Florida specific EMCs are listed in Table 4.4 for the specific pre-development land use conditions.

Table 4.4. Stormwater Pollutant Loading Input Data						
<i>Annual Rainfall</i>	<i>62" – 66"</i>					
Stormwater Event Mean Concentrations (mg/l)						
Land Use Category	Total N	Total P	BOD	TSS	Copper	Zinc
Low Density Residential ¹	1.645	0.270	5.25	25.75	0.010	0.036
Single Family	2.07	0.327	7.90	37.50	0.016	0.062
Multi-Family	2.32	0.520	11.30	77.90	0.009	0.086
Low Intensity Commercial	1.13	0.188	7.60	59.90	0.017	0.083
High Intensity Commercial	2.40	0.345	11.30	69.70	0.015	0.160
Light Industrial	1.20	0.260	7.60	60.00	0.003	0.057
Highway	1.52	0.200	5.20	46.00	0.025	0.116
Natural – Dry Prairie	2.025	0.184				
Natural – Marl Prairie	0.684	0.012				
Natural - Wet Prairie	1.095	0.015				
Natural – Mesic Flatwoods	1.09	0.043				
Natural – Scrubby Flatwoods	1.155	0.027				
Natural – Wet Flatwoods	1.213	0.021				
Natural – Upland Mixed Forest	0.606	1.166				
Natural – Upland Hardwood Forest	1.042	0.346				
Natural – Ruderal Upland Pine	1.694	0.162				
Natural – Xeric Scrub	1.596	0.156				
Range land/park land	1.15	0.055	1.40	8.40		
General Agricultural	2.80	0.487	3.80	34.20	0.012	0.021
Pasture	3.51	0.686	5.10	67.10		
Citrus	2.24	0.183	2.60	15.50	0.003	0.012
Row Crops	2.65	0.593		19.80	0.022	0.030
Conventional rooftops	1.05	0.12				
1. Average of single-family and undeveloped values						

The average annual mass loading calculation is provided in **Equation 4.4.2** below.

Equation 4.4.2. Annual Average Mass Loading = Annual Runoff Volume x EMC

The components of Equation 4.4.2 are expressed in different units and require some conversion factors, as provided below.

Annual Mass Loading (lb./year) =

$$\text{Annual Runoff Volume (ac-ft./year)} * 43,560 \text{ ft}^2/\text{ac} * 7.48 \text{ gal/ft}^3 * 3.785 \text{ liter/gal} * \text{EMC (mg/l)} * 1 \text{ lb./453,592 mg}$$

4.4.3. Calculation of Post-Development Stormwater Pollutant Loading

Calculate the post-development annual mass loadings of total phosphorus and total nitrogen in a manner similar to the pre-development loadings above. Simply multiply the post-development annual runoff volume (derived in Section 4.4.1) by the land use specific runoff characterization data (event mean concentrations or EMCs) for total phosphorus and total nitrogen listed in Table 4.4 for post-development land use conditions. The mass loading calculation is done using Equation 4.4.2.

4.5. Designing the BMP Treatment Train to Meet Required Load Reductions

Once the pre-development and post-development loadings have been calculated and the required percent reduction of TN and TP have been established, the stormwater [BMP treatment train](#) can be designed. This Manual includes a variety of BMPs, both nonstructural and structural, that can be used to reduce nutrients and other pollutants in stormwater discharges. Stormwater treatment systems are generally most effective when designed to include a combination of BMPs in series to achieve the required pollutant removal efficiency. This concept is called the “BMP Treatment Train”.

Treatment efficiencies of BMPs in series must account for the reduced loading transferred to subsequent downstream treatment devices. After treatment occurs in the first system, a load reduction has occurred which is a function of the type of BMP used to provide treatment. After load reduction in the initial BMP, the remaining load consists of pollutant mass that was not removed. This mass is then treated by the second BMP with the nutrient reduction efficiency determined by the particular type of BMP used.

To obtain an overall increase in pollutant load reduction in a BMP Treatment Train, **the BMPs must be complementary and not duplicative with respect to the types of pollutants removed.** Upstream BMPs must not reduce the treatment effectiveness of the downstream BMP. For example, using BMPs that remove solids and particulate pollutants in front of a wet detention system will actually reduce treatment effectiveness of the wet detention system. This is because most treatment in a wet detention system is a result of particle settling

The overall treatment effectiveness of a BMP Treatment Train is calculated with Equation 4.5.1:

Equation 4.5.1

$$\% \text{ Removal} = \text{Eff1} (1 - \text{Eff1}) * \text{Eff2} + (1 - (\text{Eff1} + \text{Eff2})) * \text{Eff3} + (1 - (\text{Eff1} + \text{Eff2} + \text{Eff3})) * \text{Eff4} + \dots$$

Where: Eff1 = efficiency of first treatment BMP

Eff2 = efficiency of second treatment BMP

Eff3 = efficiency of third treatment BMP

As stormwater pollutant concentrations or stormwater volumes are reduced in each BMP in the treatment train, the ability of a BMP to further reduce stormwater pollutant concentrations and loads is diminished. The treatment efficiency used for downstream BMPs must account for the diminishing effectiveness of stormwater treatment.

First, select the BMPs that will be used to meet the required TP load reductions. Once the BMPs for TP load reductions are selected, determine if the BMPs used to meet the required TP load reduction will achieve the required level of TN load reduction. **Typically, retention systems will achieve the same load reduction for both TN and TP since their treatment effectiveness is directly related to the percentage of the annual stormwater volume that is retained on-site.** However, the typical load reduction for TN and TP vary greatly in wet detention and other types of BMPs. If the TN and TP performance standards are met, complete the design of the stormwater treatment system. If they do not, either modify the selected BMPs or add BMPs to increase the pounds of TN reduction until the system meets the required amount of load reduction.

4.6. Computational Aids

Since LID BMPs are not “presumptive” BMPs, a significant amount of information is needed in the permit application process to document the BMP design criteria and the relationship to pollutant load reduction. To obtain a permit for a stormwater system an applicant must include pre-development and post-development pollutant loadings. This is relatively easy and many models can calculate such loadings. However, the difficulty is in calculating the stormwater treatment effectiveness (reduction in average annual TN and TP loadings) associated with the specific design criteria for the LID BMPs being used.

To assist designers in determining the pollutant load reduction effectiveness of proposed stormwater BMP Treatment Trains that incorporate LID BMPs, the University of Central Florida Stormwater Management Academy has created the **BMPTRAINS Model** software. This spreadsheet model is in the Public Domain and is available online for free at <http://www.stormwater.ucf.edu/>.

This software has been developed in cooperation with the DEP, the WMDs, and the Florida DOT. It is accepted by DEP and the WMDs for ERP permit applications. Its uniqueness is the inclusion of Florida specific data that are used to calculate the treatment effectiveness of LID BMPs, both individually and when they are used in either parallel or serial BMP Treatment Trains. This data includes long term Florida rainfall data by zones and locations; Florida soils and their infiltration capabilities; Florida EMCs; Florida BMP effectiveness data; and Florida LID design criteria and effectiveness data. The BMP treatment effectiveness is based on the Florida BMP research and monitoring done over the past 30 years. This includes all of the LID BMP effectiveness research and monitoring data. However, other continuous simulation methods, such as EPA SWMM or other public or proprietary software approved by the County, may also be used to calculate pre-development and post-development hydrology and loadings, providing Florida based rainfall, runoff, and loading data can be shown to be used relative to good practice.

4.7. References

1. Harper, H. H. and D. Baker. 2007. [Evaluation of Current Stormwater Design Criteria within the State of Florida](#). Final report submitted to the FDEP, June 2007.

2. USDA Natural Resource Conservation Service. 1986. Urban Hydrology for Small Watersheds. [Technical Release 55](#).
3. Wanielista, Marty, Harvey Harper, Eric Livingston, Mike Hardin, Przemyslaw Kuzlo, and Ikiensinma Gogo-Abita, UCF Stormwater Management Academy, 2016. [User's Manual for the BMPTRAINS Model](#).

CHAPTER 5 – ESCAMBIA COUNTY LOW IMPACT DESIGN BMPs

5.0. Best Management Practices

5.0.1 Introduction to BMPs

This section of the Manual sets forth technical criteria for the design, construction, operation, and maintenance of stormwater treatment systems that incorporate [Low Impact Design](#) (LID) BMPs. These newer BMPs can be used, typically in combination as part of a BMP Treatment Train, to achieve the desired minimum level of pollutant load reduction. As seen in Table 5.1, the BMPs are separated into three “phases” roughly parallel to key phases of land development and stormwater planning: site planning BMPs, source control BMPs, and stormwater treatment BMPs.

Each structural BMP section in Chapter 5 begins with a summary table that highlights the most critical information for the specific BMP covered in that section. The following information is included in these summary tables:

- Advantages/Benefits
- Disadvantages/Limitation
- Volume Reduction Potential
- Pollutant Removal Potential
- Key Design Considerations
- Key Construction and Maintenance Considerations

Criteria provided in Chapter 5 are considered minimum standards for the design of Low Impact Design BMPs in Escambia County. The requirements in Article 1, Stormwater, of Chapter 1, Engineering, of the [Escambia County Design Standards Manual](#) supplement the LID BMP design criteria in this chapter. It is unlikely that any single BMP will achieve the NFWMD and Escambia County stormwater management objectives and it is intended that these BMPs will be implemented in series with other BMPs—a [BMP treatment train](#) approach. The stormwater treatment train should be designed so that the entire stormwater system meets minimum stormwater control requirements. This includes flood control and stormwater treatment. It is important that users of this manual consult with the NFWMD Environmental Resource Permitting criteria and the County’s guidance documents on land development and stormwater management, including the [County Comprehensive Plan](#), the [Land Development Code](#), the Design Standards Manual, and the [Code of Ordinances](#), for any variations to these criteria or additional standards that must be followed.

The BMPs in this Manual achieve a wide range of average annual TN and TP load reductions. In general, retention BMPs provide the greatest level of pollutant load reduction because they reduce the annual stormwater volume discharged off-site. The treatment effectiveness of retention BMPs is directly proportional to the percentage of the average annual stormwater volume that is captured and retained on-site. Tables A1-1 and A2-1, which are included in [Appendix A](#), provide the range of pollutant load reduction associated with retaining a specific volume of stormwater under varying conditions of the percent DCIA and the non-DCIA Curve Number. For example, [Table A1-1](#) shows the stormwater volume needed to achieve 80% average annual load reduction varies from 0.25 inches to 1.92 inches. Likewise, [Table A2-1](#), which contains a series of tables based on the stormwater treatment depth, shows that the

average annual load reduction for a retention system with 0.5” treatment volume varies from 28.1% to 91.8% depending on a site’s CN and percent DCIA.

The effectiveness of wet detention systems varies depending on the average annual residence time as shown in Figures 5.1 (TP) and 5.2 (TN). In general, a wet detention system can achieve a 30% to 43% reduction in TN and a 45% to 85% reduction in TP. To increase the effectiveness of a wet detention system, one can add [Managed Aquatic Plants](#) (10% removal) or an [up-flow filter](#) to reduce pollutant concentrations, or add a [stormwater harvesting system](#) that takes water from the wet detention system and uses it for non-potable purposes, thereby reducing the stormwater volume discharged.

Figure 5.1. Removal Efficiency of Total Phosphorus in Wet Detention Ponds as a Function of Average Annual Residence Time

(From *Evaluation of Current Stormwater Design Criteria within the State of Florida*, Final Report Submitted to the FDEP, June 2007, Harvey Harper and David Baker, Environmental Research and Design, Inc.)

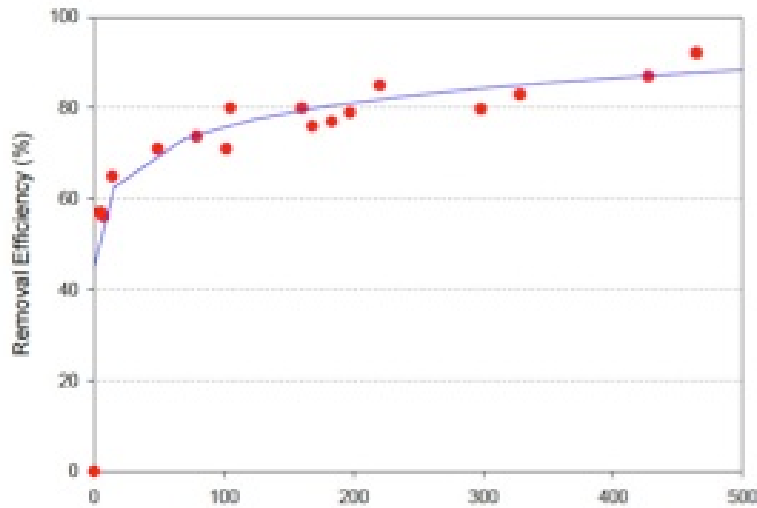
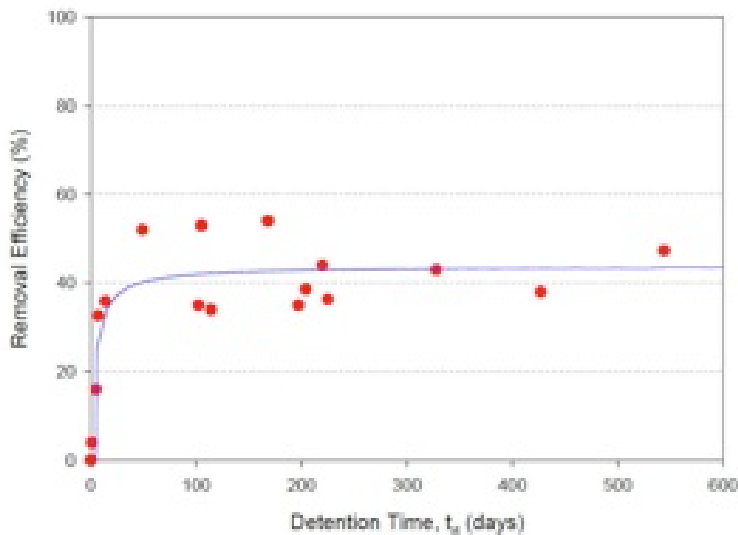

Figure 5.2. Removal Efficiency of Total Nitrogen in Wet Detention Ponds as a Function of Average Annual Residence Time



To facilitate the design of BMP Treatment Trains that incorporate LID strategies and BMPs, this Manual includes the Stormwater BMP Strategies Checklist (Table 5.1). The BMP checklist is separated into three “phases” roughly parallel to key phases of land development and stormwater planning: conceptual site planning BMPs, source control BMPs, and stormwater BMPs. Those BMPs that have [a quantifiable nutrient load reduction](#) are shown in the last column.

Table 5.1. Stormwater BMP Strategies Checklist

Site Planning BMPs	Conceptual Site Planning	Completed or Used	N/A	Load Reduction Credit
SP1	Inventory Site Assets: Hydrology			
SP2	Inventory Site Assets: Topography			
SP3	Inventory Site Assets: Soils			
SP4	Inventory Site Assets: Vegetation			
SP5	Protect Surface Waters and Wetlands			
SP6	Preserve Open Space			
SP7	Natural Area Conservation - Retain Tree Canopy and Native Landscapes			√
SP8	Cluster Design and Maximize Gross Density			
SP9	Minimize Building Footprint			
SP10	Minimize Total Impervious Area			√
SP11	Minimize Directly-Connected Impervious Area			√
SP12	Curb Elimination and Curb Cuts			
Source Control BMPs	Source Control Techniques	Completed or Used	N/A	Load Reduction Credit
SC1	Retain Natural Landscape Depressions			
SC2	Minimize Clearing and Grading			
SC3	Minimize Soil Disturbance and Compaction			
SC4	Build with Landscape Slope			
SC5	Retain Native Landscapes at the Lot Level			
SC6	Florida-friendly Landscapes and Fertilizers			√
SC7	Rainfall Interceptor Trees			
SC8	Install Efficient Irrigation Systems			
SC9	Use Non-potable Water Supply for			

	Irrigation			
SC10	Community and Home Owner Education			
Structural BMPs	Structural Stormwater BMPs	Completed or Used	N/A	Load Reduction Credit
SW1 – Section 5.3	Retention Basin			√
SW2 – Section 5.4	Exfiltration Trench			√
SW3 – Section 5.5	Underground Storage and Retention			√
SW4 – Section 5.6	Rain Gardens (Bioretention)			√
SW5 – Section 5.7	Treatment Swales			√
SW6 – Section 5.8	Vegetated Natural Buffers			√
SW7 – Section 5.9	Pervious Pavements			√
SW8 – Section 5.10	Green Roofs with Cisterns			√
SW9 – Section 5.11	Rainwater Harvesting/Cisterns			√
SW10 - Section 5.12	Stormwater Harvesting/ Horizontal Wells			√
SW11 - Section 5.13	Up-Flow Filter Systems			√
SW12 - Section 5.14	Managed Aquatic Plant Systems			√
SW13 - Section 5.15	Biofiltration Systems with Biosorption Activated Media			√

5.0.2. Integrating Landscaping and Low Impact Design BMPs

Section 2-2407.56 of Chapter 2, Environmental, of the Design Standards sets forth requirements for stormwater systems to be used to partially meet the 15% to 30% landscaping requirements. With respect to stormwater BMPs, this section states:

“On-site permeable retention/detention ponds and permeable swales qualify as landscaping areas if their maximum depths are no more than three feet and their side slopes are no steeper than 2-1.”

LID techniques that could meet these requirements include, but not limited to, retention basins, rain gardens (bioretention), treatment swales, and vegetated natural buffers.

5.1. Site Planning BMPs

Site Planning Best Management Practices should be applied as part of the development design process to ensure efficient land usage and preservation of the area’s natural hydrology. The following twelve (12) site planning considerations should be considered for each project. These

site planning principles are associated with Smart Growth practices. Additional information pertaining to sustainable site planning may be found at www.epa.gov/smartgrowth.

The first step in using the Site Planning BMPs is to know what land and water resources are designated as “environmentally sensitive.” Section 4-5.2 of Article 5, Natural Resources, of the [Escambia County LDC](#) designates the following land and water resources that are designated as ‘environmentally sensitive’:

1. Wetlands as defined by the State of Florida.
2. Shoreline protection zones as defined in this article.
3. Aquatic preserves and the Escambia River Wildlife Management Area as defined or authorized by Florida Statutes.
4. Outstanding Florida Waters as listed in the rules of Florida Administrative Code ([Ch. 62-302.700, F.S.](#)).
5. Habitats of threatened and endangered species as defined by the U.S. Fish and Wildlife Service (FWS), the Florida Fish and Wildlife Conservation Commission (FWC), or other state or federal agencies.
6. Essential fish habitat, including seagrasses, defined as those waters and substrate necessary for fish to spawn, breed, feed, or grow to maturity. (See Magnuson-Stevens Act, 16 U.S.C. 1802 (101)).
7. Floodplain areas identified on the Federal Emergency Management Agency’s Flood Insurance Rate Map as areas of special flood hazard subject to a one percent or greater annual chance of flooding.
8. Wellhead protection areas as defined in this article, including potable water wells, cones of influence, and potable water well fields.
9. Surface waters identified as [impaired](#) under Section 303(d) of the Clean Water Act

Use the Inventory Site Assets Site Planning BMPs to map and identify these environmentally sensitive land and water resources on your site. Where the potential for on-site wetlands or the habitat of threatened or endangered species is indicated, Section 4-5.2(d) of the Escambia County LDC requires a site-specific survey be conducted and include the delineation of all such lands on the project’s parcel. The survey will be evaluated for the protection of significant resources prior to clearing, grading or other alterations, and the delineations shall be used in the determination of buildable area on the lot or parcel.

SP1. Inventory Site Assets: Hydrology

Identify and retain the predevelopment hydrology to the maximum extent possible, including natural flow, conveyance paths and patterns, and drainage features. Replicate original site hydrology by maintaining predevelopment surface runoff, infiltration, and evapotranspiration rates and hydrologic assets of the site to the fullest extent possible. When assessing a site for LID opportunities, it is important to understand the stormwater sources and sinks in each catchment and sub-catchment, and plan accordingly.

Does runoff leave the site through surface or subsurface drainage? Is there potential for sinkhole formation or stream bank erosion? Both peak and total volume of runoff can contribute to erosion.

Are there adjacent land uses or sites that will contribute additional stormwater runoff or pollutant loads that will need to be addressed? In this phase of planning, the need for buffer strips or other strategies to protect sensitive areas (water bodies, steep slopes, desirable wildlife or cultural areas) in or adjacent to your site should also be identified.

SP2. Inventory Site Assets: Topography

The predevelopment topography should drive the design of a project and stormwater system, rather than altering the topography of the site during development to fit a traditional stormwater management plan. Use the topographic characteristics of the site to guide the road layout and stormwater conveyance features, and consider the natural drainage patterns when delineating lots and placing public infrastructure. Topographic features should also guide lot-level landscape layout and plantings. For instance, avoid re-contouring and installing high-maintenance landscaping or turf, or disturbing areas with steep slopes or natural landscape depressions that should be preserved for their infiltration capacity. Natural depressions should be maintained where possible to promote storage, infiltration, and treatment during typical stormwater events and to capture part of the treatment volume during extreme events.

SP3. Inventory Site Assets: Soils

Inventory and delineate the extent of all soil types present on site. In combination with topography, determine the erosion potential of soils, especially clayey soils. Determine the hydrologic group classifications of soils and their capacity for stormwater infiltration. Clearly mark on drawings and designate on site all areas that will be vegetated or used in stormwater management to prevent their compaction and maintain the soil infiltration capacity. Consider any significant differences in infiltration potential when planning and laying out the proposed development. Employ careful site clearing, grading, equipment and materials staging when planning construction to limit compaction and protect native soil characteristics.

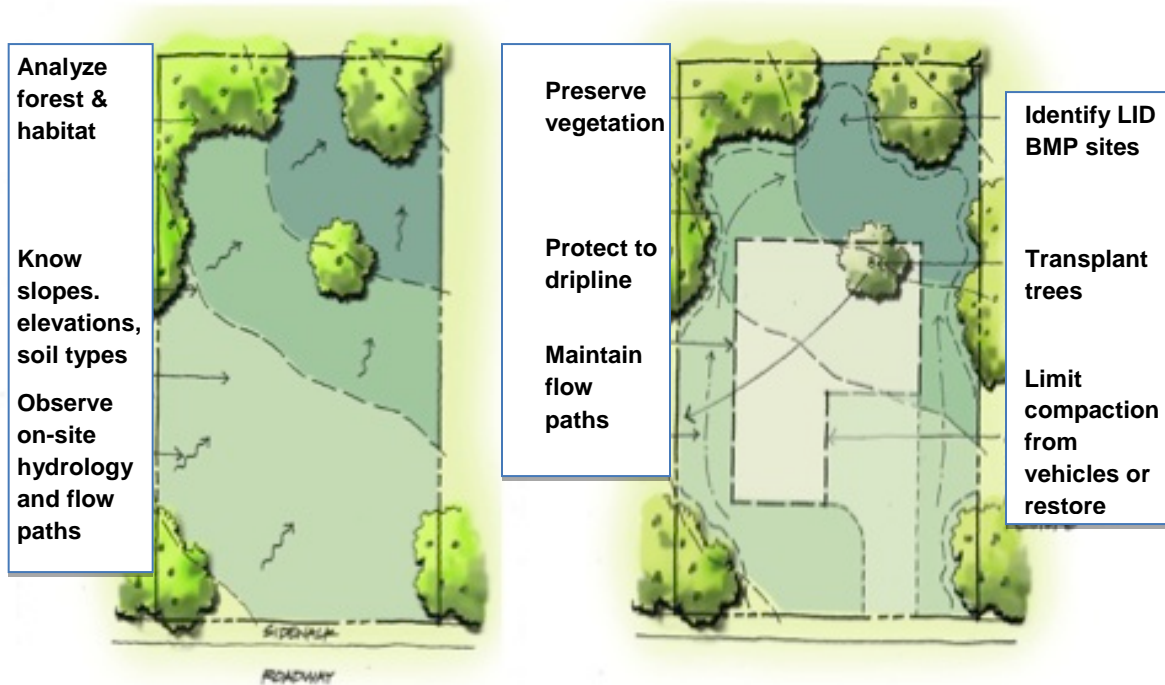

Consider site vegetation and topography, maintain natural hydrology, and limit soil compaction.

SP4. Inventory Site Assets: Vegetation

Protection of trees and native vegetation promotes carbon dioxide absorption, oxygen production, dust filtration, and reduction of wind, noise, and glare. Trees also provide soil

stabilization and enrichment, erosion prevention, surface drainage improvement, aquifer recharge and water pollution reduction. They also provide wildlife habitat, energy conservation, temperature moderation, the economic enhancement of improved and vacant lands, scenic beauty, quality of life, and the health, safety, welfare and well-being of the community.

[Escambia County LDC](#) Article 7, Landscaping, within Chapter 5, General Development Standards, includes language that is directly applicable to the Inventory of important vegetation on the site, both desirable and undesirable. However, the specific requirements for tree protection and landscaping are set forth in Article 2, Landscaping, within Chapter 2, Environmental, of the Escambia County Design Standards Manual.

Article 2-3, Tree Protection and Preservation, sets forth requirements to preserve, protect, and encourage the proliferation of trees and native vegetative cover. The following trees are protected and require a permit for removal:

- Any tree 12 inches or greater in diameter at breast height (DBH).
- Any sand live oak (*Quercus geminate*) having five or more stems (trunks), or having three or more stems each three inches or greater in diameter, that is located on Pensacola Beach or Perdido Key, or within any shoreline protection area.
- Any tree planted or preserved to meet tree replacement or landscape requirements of the LDC.
- [Heritage trees](#) – a protected tree 60 inches or greater in diameter (DBH).

Article 2-4 sets forth the requirements for a tree inventory and assessment of protected trees. It also requires the removal or eradication of prohibited and discouraged non-native vegetation.



Avoid complete site clearing



Retain trees where possible

Section 4-5.5(c)(a)(5) prohibits the removal or destruction of native vegetation within the shoreline protection zone. Section 4-5.5(c)(a)(3) protects the natural vegetation of shorelines of estuarine systems and requires erosion prone areas to use natural methods of shoreline protection (i.e. living shorelines) by stabilizing them with appropriate native vegetation in accordance with accepted engineering and environmental practices.

SP5. Protect Surface Waters and Wetlands

Surface waters is a comprehensive term that includes all rivers, streams, creeks, springs, lakes, ponds, intermittent water courses and associated wetlands that hold or transport water on the ground surface. Protect surface waters and wetland edges by using buffers and native plantings.

Section 4-5.3 of the Escambia County LDC requires upland buffers with a minimum width of 15-ft and an average width of 25-ft be provided abutting those wetlands under the regulatory jurisdiction of the State of Florida under 62-340, F.A.C. A 10-ft average upland buffer shall be required for development activities that avoid impacts to wetlands.

Section 4-5.5(c)(a)(1) establishes a marine shoreline protection zone along the shorelines of Santa Rosa Island and Perdido Key, extending from the mean high water line (MHWL) of the Gulf of Mexico landward to the 1975 Coastal Construction Control Line. Similarly, paragraph (b)(2) establishes an estuarine shoreline protection zone along the estuarine shorelines extending 15 feet landward of the mean high water line (MHWL). Finally, paragraph (c)(2) establishes a riverine shoreline protection zone along riverine shorelines, extending 30 feet landward from the ordinary high water line.

Finally, [Appendix C](#), lists all of the receiving waters within Escambia County for which DEP has established a WBID number. Within the table, those waters that are not meeting their applicable [water quality standards](#) (Verified Impaired Waters) or for which a [Total Maximum Daily Load](#) or [Basin Management Action Plan](#) has been adopted are identified. Any project within the sub-watershed of these water bodies must meet the “Net Improvement” performance standard for stormwater treatment ([Section 4.3.1](#)).

SP6. Preserve Open Space

Once a thorough inventory of the site assets that facilitate LID BMPs has been completed, the first planning strategy is to preserve these assets to the maximum extent possible. Consider all areas where open space and pervious areas can be protected. Escambia County requires a minimum of from 15% to 30% permeable area, depending on the Zoning District. In addition, the Perdido Key Zoning Districts require 30% permeable area with another 30% to 35% open space. The County’s LDC definition of “open space” includes yards and landscaped areas, and the LDC landscaping requirements allow shallow retention LID BMPs within these areas.

Not all sites contain significant areas of natural areas that can be preserved, but where they exist, several established ecological principles should be considered when initially laying out development and setting aside open spaces.

- The objective is to reduce the length of edges between the development and natural area. Edges have greater disturbance, more predators, and poorer habitat for many species. The width of an edge varies by species, but can extend 150-300 feet into a patch of habitat, equivalent to about an 8 acre circle.
- The shape of natural areas is important for minimizing the effects of development on many plants and animals. Therefore, one 15 acre natural area is much better than five- three acre natural areas. Similarly, a roughly circular shape has a shorter perimeter than a long narrow or irregularly shaped site with the same area.
- Patches with “soft” edges (gradual & undulating vegetation) are better than those with “hard” edges (straight & sudden)
- It is not always possible to design a natural area with inland areas free of edge effects. However, any open space is better than none, as some species will still benefit despite edge effects.
- Where there are several patches of natural habitat, connecting them with a corridor is desirable. Wide corridors are better than narrow, and natural corridors are better than man-made.
- If both exist on site, wet *and* dry areas should be included in a preserved area.
- Preserve rare natural communities over more common ones, using the Florida Natural Areas Inventory state and global rarity ranking.

SP7. Natural Area Conservation - Retain Tree Canopy and Natural Landscaping

Tree canopy can be viewed as the first line of defense in stormwater source control. Retaining native and large tree canopies to the maximum extent possible and planning new tree plantings to maximize tree canopy over the life of the project will help retain and enhance predevelopment interception and evapotranspiration capacity, reducing generation of stormwater runoff. There is evidence that tree canopies have the potential to intercept approximately 15-20% of the water in a storm event that falls on their leaves. This water is retained by surface tension and reduces



Trees were retained at this site, but avoid mounding soil around the base of the trees, as they did here!

the potential for runoff from impervious surfaces directly underneath the canopy, a virtual “retention pond in the sky”.

Position or plant trees so that when they are fully grown (10-40 yrs., depending on species) they will cover impervious surfaces or shade buildings during the summer months from noon to late afternoon. Use deciduous trees when and where appropriate to provide shade in the summer months and maximize solar gain during the winter months.

Maximize the amount of tree canopy cover over impervious surfaces to get stormwater credit for using Interceptor Trees.

Existing trees on the proposed site must be retained and protected as described in the [Escambia County LDC Design Standards Manual](#), Chapter 2, Article 2-3. As set forth in Article 2-3.2, the protection area includes the Critical Root Zone and the Structural Root Plate. Raising or lowering the grade level around trees, by even a few inches can adversely impact these areas and kill the tree. Lowering the grade is likely to remove important root mass, while raising it can prevent oxygen from reaching the roots, smothering them.

Natural Area Conservation Pollutant Load Reduction Credit: Protection of natural areas and their associated vegetation helps maintain the undeveloped hydrology of a site by reducing runoff, promoting infiltration and preventing soil erosion. The undisturbed soils and native vegetation of conservation areas promote rainfall interception and storage, infiltration, runoff filtering and direct uptake of pollutants. Natural areas are eligible for stormwater credit if they remain undisturbed during construction and are protected by a permanent conservation easement prescribing allowable uses and activities on the parcel and preventing future development. Examples of conservation areas include any areas of undisturbed vegetation preserved at the development site, such as forests, floodplains and riparian areas, steep slopes, and stream, wetland and shoreline buffers.

1. Calculation of Stormwater Treatment Credit

Natural areas that are placed into conservation shall be excluded from the runoff calculations used to determine the volume of stormwater that must be treated or to calculate pre- and post-development nutrient loads.

2. Conditions for Credit

Proposed conservation areas shall meet all of the conditions outlined below to be eligible for credit:

- The minimum combined area of all natural areas conserved at the site must exceed one acre.
- No disturbance may occur in the conservation area during or after construction (i.e., no clearing or grading except for restoration operations or removal of exotic vegetation unless provided for within the conservation easement).
- The limits of disturbance around each conservation area shall be clearly shown on all construction or permit drawings.
- A long-term vegetation management plan must be prepared to maintain the conservation area in a natural vegetative condition. Managed turf is not considered an acceptable form of vegetation management, and only the passive recreational areas of dedicated parkland are eligible for the credit (e.g., ball fields and golf courses are not eligible).
- The conservation area must be protected by a perpetual easement that is filed in the public records prior to beginning construction.
- The credit may be granted for natural areas already protected by existing federal, state, local law, or existing conservation easement.

SP8. Cluster Design and Maximize Gross Density

While the terms “clustering” and “high density” are sometimes equated, and high-density design may be perceived and portrayed as contrary to smart growth principles, both are useful strategies from an LID design perspective.

Clustering of built infrastructure at the development or subdivision scale is a preferred technique that can significantly reduce the overall environmental impacts of a project. This strategy is useful primarily for residential and mixed-use developments. Cluster design typically reduces the length of roads (and therefore transportation infrastructure costs as well), total impervious area and area needed for stormwater management infrastructure, and reduces overall site disturbance. It also allows the opportunity in project design to maintain natural areas and wildlife habitat.

Another important, yet simple LID strategy to consider (also particularly for residential subdivisions or mixed-use developments) is maximizing gross density by designing for smaller lots. Escambia County is encouraging this type of LID design by using gross density rather than lot size requirements where possible. This approach does not reduce the total number of permitted units per acre and provides the design engineer flexibility in planning to protect the most ecologically sensitive and valuable portions of a site. By reducing the total project impact, the use of both clustering and smaller lot sizes (in some cases) may allow the developer to increase the total number of developed units or lots, thereby increasing total project revenues.

For example, clustering to increase density from 1 unit/acre to 4 units/acre, while maintaining the same total number of units, has been estimated to reduce the average annual stormwater runoff for the total site by 67% ([EPA, 2006](#)). Therefore, the total stormwater runoff from the entire site will be reduced, even though runoff from the more densely developed portion of the site may increase. Furthermore, other benefits of clustering extend well beyond reducing stormwater runoff volumes and loads.

For a discussion of high- vs. low-density developments and detailed information on the water quality benefits of compact development, see EPA’s Protecting Water Resources with Higher Density Development (2006) at www.epa.gov/smartgrowth.

SP9. Minimize Building Footprint

To reduce the impervious footprint of the project and disturbance of the site, consider multi-story building design options for the project (i.e., build vertically). Buildings with more than one story maximize the square footage to roof area ratio and lessen the stormwater runoff from the site.



On sloping sites, rather than importing fill to make a level site for slab-on-grade foundations, use stem-wall construction and minimize the area disturbed and compacted. Fill material in Florida usually has a significantly different composition from native soils, particularly in the potential for phosphorus leaching.

In the example illustrated below, the pH of fill material was 7.3 vs. 5 in native soil, and leachable P was on the order of 50 to 100 times as great.



SP10. Minimize Total Impervious Surface Area

Minimizing total [impervious surface area](#) reduces the post-development stormwater volume and peak discharge rate. The County’s LDC allows impervious surface area coverage ranging from 70% to 85% of the site. However, there are many design options to minimize total impervious surface area, thereby increasing the potential for infiltration of stormwater, particularly with street and parking design. Street design should look for a layout that reduces the total street length; curvilinear roads and short cul-de-sacs typically save 20-25% over a strict grid pattern. Narrower lots and cluster design maximize the number of lots per unit length of pavement. Neighborhoods that emphasize short, walkable streets offer efficient use of resources and structure that encourages desirable connected communities. Shared multi-use open space and easily accessible commercial areas are also features of this type of development.

Another way to reduce impervious pavement is to narrow street widths as much as possible. Narrow roads can be used for residential streets with traffic volume of 500 trips per day or less. Wider roads are often perceived to be safer, but narrow streets tend to cause drivers to slow down. Greater width encourages higher speed, which is the main cause of both pedestrian and vehicle accidents. Pervious pavements can be incorporated to provide wider access for emergency vehicles and on-street parking.

Escambia County requires cul-de-sacs to have a minimum inside curb face diameter of 90 feet. If a larger radius is required, using recessed center landscaped islands (bioretention areas) will reduce the amount of impervious area and provide for stormwater infiltration. In some designs

cul-de-sacs may be replaced with a T shaped turn-around or loop roads, which substantially reduce pavement.

Eliminate alleyways and paved auxiliary roads to the greatest extent possible. When auxiliary roads are necessary, use load-bearing pervious pavements or permeable pavers. Also reduce sidewalk widths and consider incorporating shared driveways to reduce impervious area. Sidewalks are usually not required on both sides of residential streets. As previously discussed, smaller lot sizes reduce street length; similarly, reduced setbacks from the roadway will shorten driveways and lessen paved areas. However, overall impact must be considered, as larger setbacks may be required to incorporate roadside swales.

Parking lots should be designed to use small parking space dimensions and the fewest number of parking spaces necessary. [Pervious pavement](#) can be used for many parking lots, especially for overflow parking (for seasonal or rare events). Maximize infiltration capacity of parking areas by using structurally-reinforced grass areas or pervious gravel areas for overflow parking. Where possible, design impervious areas to first drain into interior recessed rain garden islands with overflow directed via sheet flow across pervious areas to swales or finally a piped conveyance system.

SP11. Minimize Directly-Connected Impervious Area (DCIA)

[Directly connected impervious areas](#) allow runoff to be conveyed without interception by permeable areas that allow for infiltration and treatment. Disconnecting impervious areas from roofs, small parking lots, courtyards, driveways, sidewalks and other impervious surfaces allows runoff to flow onto adjacent pervious areas where it is filtered or infiltrated. Reduce DCIAs by designing the site to divert sheet flow into a swale, infiltration basin, rain garden, vegetated natural buffer or other pervious area for treatment. Disconnection of rooftops offers an excellent opportunity to harvest this rainwater and either reuse it or distribute it over lawns and other pervious areas where it can be filtered and infiltrated. Downspout disconnection can infiltrate runoff, reduce runoff velocity, and remove pollutants. Alternately, downspouts can be directed to a cistern, rain barrel, dry well, rain garden or landscaped infiltration area (See [Rainwater Harvesting BMP](#)).

Use curb cuts or uncurbed roads that will drain to vegetated swales as a method to reduce directly-connected impervious areas (See SP12). To the greatest extent possible, drain parking lots to vegetated swales, exfiltration systems, or interior vegetated parking lot islands that have been designed as rain gardens. Incorporate underdrains or elevated culverts to protect against flooding.

At the project level, disconnection of impervious area can go a long way in reducing the need for costly stormwater conveyance and treatment infrastructure. Reduce the connectedness of impervious areas by treating the stormwater incrementally, close to the source of generation. Instead of gathering all stormwater runoff from parking areas and building roof and piping it to a large, centralized basin. Gather and treat the stormwater from each roof side into separate, small rain gardens on each side of the building. Again, pervious pavement should be considered for parking or drain runoff to vegetated areas where possible.

As seen in Table 4.3, the required stormwater treatment volume is directly related to the amount of DCIA. Disconnecting small areas of impervious cover from the storm drain system can greatly reduce the total volume and rate of stormwater runoff. Credits for surface disconnection are subject to the restrictions below concerning the length, slope, soil characteristics of the pervious area which are designed to prevent any reconnection of runoff with the storm drain system. In some cases, minor grading of the site may be needed to promote overland flow and vegetative filtering.

DCIA Stormwater Treatment Credit - The total disconnected impervious area is moved from the Directly Connected Impervious Area calculations of stormwater treatment volume to the non-DCIA area when computing the stormwater treatment volume. This will reduce the stormwater volume, which then reduces the stormwater pollutant loading.

Conditions for Credit - For the purposes of the stormwater treatment rule, impervious area is disconnected if all of the following conditions apply for the overland flow of stormwater:

- The contributing impervious area is not more than 50% larger than the overland flow area.
- Non-directly connected impervious areas include all pervious areas and portions of impervious areas that flow over at least 10 feet of pervious areas with HSG A or B soils and over at least 20 feet of pervious area for other soil types.
- The roof runoff is diverted into a cistern, rain barrel, or other storage device where the water is reused for non-potable purposes (rainwater harvesting).
- The surface slope for overland flow must be between 0.5% and 5.0%.
- The velocity of runoff from a 5-year frequency storm must not exceed 0.15 feet per second.
- The infiltration capacity of soils in the overland flow path must be sufficient and not reduced by compaction, or amendment and tilling will be required to restore permeability.

Soil amendments, as discussed in the Biofiltration Section, may be needed to restore porosity of compacted pervious areas. Soil amendments refer to tilling, composting, or other amendments to urban soils to recover soil porosity, increase water-holding capacity, and reduce runoff. Soils in many urban areas are highly compacted as a result of prior grading, construction traffic and ongoing soil disturbance. Amendments recover soil porosity by incorporating compost, top soil, and other soil conditioners to improve the hydrologic properties of lawns or landscaped areas.

SP12. Curb Elimination and Curb Cuts

Curbs and gutters have been standard features of “drainage systems” for roadways and parking lots, intercepting and directing runoff into drainage pipes in an efficient manner. However, they are often inconsistent with the goal of maintaining natural hydrology. Curbs concentrate runoff into faster flowing, more erosive streams of water. Simply eliminating curbs and allowing stormwater to drain in sheet flow from roadways onto vegetated areas slows runoff and reduces peak discharge rates. If used in conjunction with downstream infiltration BMPs, total stormwater volume is reduced and stormwater pollutant loads are reduced.

If barriers are desired to bar vehicles from the shoulders of streets, curbs with cuts or raised semi-spherical knobs can be used for this purpose without obstructing the flow of stormwater. Curbs may also be desired to protect landscaped areas from pedestrian traffic in public



locations. Pavement must be graded so that stormwater flows through the curb cuts onto the vegetated area. Thus, roadways and other paved areas can be changed from DCIA to non-DCIA areas, reducing the calculated required treatment volume.

If a site does not meet the criteria for non-DCIAs, the elimination of curbs or curb

cuts, etc. can still be used to direct flow onto grassed verges, vegetated swales or rain gardens. Changing the traditional curb and gutter approach is a simple, very cost-effective method of stormwater management. It can easily be used to retrofit areas with existing curbs, by making cuts at low points in the curb to direct runoff onto other LID stormwater features.

Design Considerations: The first design decision is whether curbs are needed at all. In many residential communities, curbs are unnecessary. In commercial and other public areas, curbs are often desired to maintain proper traffic patterns. Tire stops can also serve this purpose. If curbs are desired, eliminating stormwater inlets and piped conveyances can still be considered if runoff is directed to pervious areas through curb cuts. Whether gutters are required depends on how stormwater is being treated and managed downstream.



Think this...



instead of this.

If curb cuts are to be used, their number, placement and design should be evaluated.

- An opening 18 inches wide is recommended to reduce the potential for clogging.
- The sides can be vertical or angled at 45 degrees.
- The bottom of the curb cut must slope away from the pavement.
- A 2" drop is recommended between the pavement and the vegetated area.
- Consider whether a concrete pad or gravel area is needed to dissipate energy and prevent erosion at entry points to rain gardens or parking lot islands. 100 feet

Note, the street profile must match the intended drainage; i.e., a crowned street will drain to both sides, or a side shed profile will drain to only one side.

Maintenance: Inspections are required before the beginning of each rainy season (April-May) to check that runoff is flowing as intended, that any curb cuts are not blocked by sediment, vegetation, or debris, and that soil in the downstream, vegetated area is not being eroded.

5.2. SOURCE CONTROL BMPs

Often the most cost effective and simple stormwater volume and water quality goals are accomplished by managing rainfall and stormwater runoff at the source. **Source control techniques** can be defined as nonstructural BMPs that reduce the amount of stormwater that runs off a site (**volume source controls**), or act as a preventative to lessen the nutrients and other pollutants that are picked up and carried by stormwater (**concentration source controls**). These can include many strategies ranging from disconnecting impervious areas to minimizing paved areas to education programs to teach homeowners to use less Florida-friendly fertilizer on their Florida-friendly landscapes. Source controls are usually low cost, simple techniques that could be described as the “ounce of prevention” that is worth more than a “pound of cure”.

Typically, the most expensive elements of conventional stormwater systems are the conveyance and treatment structures, particularly as the physical distance from the source to a discharge point increases. When a site is proposed for development or redevelopment, the easiest way to maintain or restore the predevelopment hydrology is to implement control measures as close as possible to the source. Suites of distributed, source control strategies at the lot or project level are the keystones of LID BMP treatment trains.

SC1. Retain Natural Landscape Depressions

Natural depressions in the landscape are Mother Nature’s [retention](#) systems. They should be preserved where possible to promote storage, infiltration, and treatment of stormwater. Lot lines can be determined in part by location of natural depressions, and one or more per lot can be used to install rain gardens on individual lots. Again, remember to view these natural landscape depressions as LID assets and potential environmental and marketing (homeowner) amenities.

SC2. Use Selective Site Clearing and Grading

To preserve the natural topography and avoid disturbing native soils, carefully plan clearing, grading, and construction. Then clearly delineate the areas on the ground and instruct all construction personnel on their purpose and importance. This will minimize soil compaction over the entire site - the ultimate goal being completely undisturbed soil in all areas except the building and impervious surface footprint. Use existing roads, future road areas, or previously compacted areas for materials staging.



SC3. Minimize Soil Disturbance and Compaction

The fertility, infiltration capacity, extent of compaction and stability of native soils will constrain the landscape design and management plan to varying extents. All LID BMP projects should evaluate the likely impacts of development on site soils and attempt to minimize adverse impacts. This can be done through preservation and protection of planned vegetated areas, and soils that will not be covered by impervious materials throughout the project to the maximum extent possible.

As demonstrated in the table, research on infiltration rates of sandy soils in North Florida has demonstrated that compaction reduces infiltration rates by between 80 and 99 percent by

construction equipment (Gregory, 2006). This has a greater impact than the soil classification in many cases, and stormwater runoff prediction may be significantly underestimated by ignoring the effects of compaction.

SOIL TYPE	INFILTRATION RATE (IN/HR)	
	PITT ET. AL. (Alabama)	GREGORY (Alachua County)
Sandy Soils	13.0	14.8 - 25
Compacted Sandy Soils	1.4	0.3 – 6.9
Clay Soils	9.8	NA
Compacted Clay Soils	0.2	NA

Compaction of the top 6 inches is primarily related to tire pressure, and compaction of greater depths is related to the total weight of the equipment, affecting primarily the top foot of soil, but some compaction continues up to 3 feet. The degree of compaction varies with the soil type, pH, the organic and mineral content and moisture level.

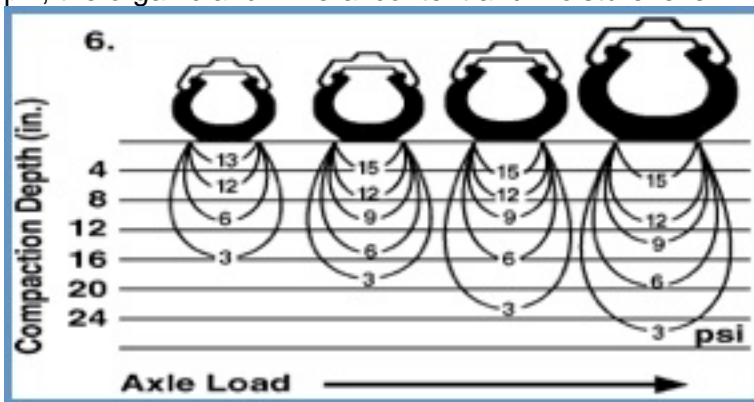

Up to 80% of compaction occurs during the first pass of a vehicle!

The upper layers of sandy soil can recover in 4-9 years, but some soils with high clay content have taken more than 40 years to recover.

Remember that regardless of how well a structural infiltration-based BMP is designed, it will only achieve its design goals if the infiltration capacity of site soils meets design standards. Similarly, even the hardies, drought-tolerant trees and plantings cannot thrive if the soils in which they are planted have been excessively compacted. Although soils disturbed during site preparation and construction should be amended with compost to restore some permeability and infiltration capacity, most soils cannot be returned to their natural state. Avoiding compaction is far preferable and less expensive. It is imperative that sites intended for infiltration BMPs be clearly designated and not traversed by heavy construction equipment.

SC4. Build with the Landscape Slope

Retain the natural slope of the landscape by designing buildings and infrastructure around existing topography, rather than re-contouring the land to fit the building design. Build with the slope of the landscape by considering stem wall construction or pier and beam/raised floor foundations (rather than the traditional slab-on-grade) for homes and buildings. Raised floor construction without exterior fill on sloped sites reduces fill needs and lot-level soil disturbance.

SC5. Retain Native Landscapes at the Lot Level

Minimize the planned area requiring imported or constructed landscapes. Plant and maintain Florida-friendly or native vegetation wherever possible (i.e. celebrate Florida’s native plant diversity). Minimize use of turf grass and use it only where outside active recreation is planned and frequent. Plant native vegetation in beds that will require little or no irrigation after

establishment. Native trees and shrubs can be watered with temporary perforated hoses laid on top of the ground and covered by mulch. They do not need to be irrigated by permanent in-ground systems. Homeowners should be instructed to remove the hoses in approximately one year, after plants are established.

SC6. Florida-Friendly Landscaping and Fertilizers



Recent studies have shown that nitrate levels are rising in many water bodies, especially springs. Nitrate is a form of nitrogen that is found in inorganic fertilizers. Nitrogen is needed to help landscapes stay healthy. When fertilizer is applied correctly, the lawn or plants will use all the nitrogen. If applied incorrectly, nitrogen can leach into our ground water or wash off the land and into lakes, rivers and the Gulf. Once in our water bodies, nutrients from fertilizer may cause algae to grow. Algae can form large blooms that shade out beneficial aquatic plants and use oxygen that fish need to survive.

Minimize new landscaped areas requiring supplemental Inputs of fertilizer and irrigation by creating a Florida-friendly landscape (<http://www.floridayards.org/>). Plan your site for low-impact and resource-efficient landscapes that have the capacity to thrive without supplemental inputs of irrigation, fertilizers, pesticides, herbicides, etc. Minimize turf lawns as needed for family activities or replace turf with Florida-friendly ground covers and vegetation. Perennial peanut makes an excellent ground cover and was used at the County Office Complex. Grasses are dormant during winter from about November until mid-March. Dormant grasses require little to no watering. Watering may be needed in April, May, and October since those months are usually dry. Irrigate in the hour before dawn to reduce water loss due to evaporation or wind. Irrigate only one or two days per week (as per current Water Management District watering regulations). Use rain monitors and/or soil moisture sensors to reduce unnecessary water use and regulate irrigation timers. Where possible, irrigate with non-potable water such as rainwater (See [Rainfall Harvesting BMP](#)), stormwater (See [Stormwater Harvesting BMP](#)), or reclaimed water. However, if using reclaimed water be sure to find out the concentration of nitrogen and phosphorus and do not overwater. This will lead to stormwater coming off the landscape and create nutrient loading into downstream stormwater conveyances and water bodies. Over use of reclaimed water can increase stormwater [EMCs](#) by 50%.

Be sure to use Florida-friendly fertilizers (<http://www.swfwmd.state.fl.us/yards/fertilizing/>) and download the [Do-It-Yourself Guide to Florida-friendly Fertilizing](#). The Florida Department of Agriculture and Consumer Services passed a rule ([Chapter 5E-1.003, F.A.C.](#)) regulating labeling requirements in Florida for urban turf fertilizers. The new labeling requirements will make it easier for homeowners to find lawn fertilizers with both slow-release nitrogen and low phosphorus. This rule is intended to reduce potential pollution that might result from application of excess fertilizer to lawns.

Florida-friendly Urban Turf Fertilizer Labeling Requirements:

1. Specialty Fertilizer products labeled for use on urban turf or lawns shall be no phosphate or low phosphate.
 - “No phosphate” fertilizers shall not contain more than 0.5% of available phosphate expressed as P₂O₅. The “grade” shall indicate a zero guarantee.

- Fertilizers labeled as low phosphate shall have use directions that do not exceed an application rate of 0.25 lbs. P₂O₅/1000 sq. ft. and not to exceed 0.50 lbs. P₂O₅/1000 sq. ft. per year.
 - Fertilizers labeled as, or formulated for use as, starter fertilizer shall have use directions that do not exceed an application rate of 1.0 lb. of P₂O₅/1,000 sq. ft. and that subsequent applications shall be made with products meeting the definition of Low or No Phosphate fertilizers. The term “starter fertilizer” shall be part of the brand name
2. Fertilizers labeled as urban turf or lawn fertilizer shall have directions for use for nitrogen that:
- Are consistent with the annual nitrogen recommendations in the table below.
 - Nitrogen shall not be applied at an application rate greater than 0.7 lbs. of readily available nitrogen per 1000 sq. ft. at any time based on the soluble fraction of formulated fertilizer.

TURF SPECIES	Bahiagrass	Bermuda	Centipede	St. Augustine	Zoysia
Timing of Application: Only apply fertilizer to actively growing turf (needs mowing at least once every two weeks)					
Maximum pounds of Nitrogen per fertilizer application					
Spring or summer	2	2	2	2	2
Fall or Winter	1	1	1	1	1
Maximum Annual Pounds	2-3	3-5	1-2	2-4	2-3

- Not more than 2 lbs. of total nitrogen per 1000 sq. ft. per application may be applied during the spring or summer;
- Not more than 1 lb. total nitrogen per 1000 sq. ft. per application may be applied during the fall or winter.
- If a total controlled release product is applied, not more than 35 percent of the nitrogen in the controlled release fertilizer can be released within the first 7 days after application.

Stormwater Treatment Credit – If a higher level of treatment is needed than is required by the NFWFMD, residential developments designed in accordance with the principles of the Florida-Friendly landscaping program may be able to receive a three percent (3%) TN load reduction credit. Since this is a Source Control BMP that minimizes the amount of nitrogen and phosphorus fertilizer applied, the load reduction credit can be claimed first when performing nutrient loading calculations.

Conditions for Credit - A development project shall meet all of the conditions outlined below to qualify for the [Florida-Friendly landscaping](#) stormwater treatment credit:

- The entire development project has all landscaping designed and constructed in accordance with the principles of the Florida-friendly landscaping program and Article 2-6, Plant selection, installation, and irrigation, of Chapter 2 of [the Design Standards Manual](#).
- The development shall implement and record deed restrictions and other restrictive covenants based on the [Model FYN Deed Restrictions and Restrictive Covenants](#).

- All fertilizers shall be [“Florida-friendly” fertilizers](#) and their application consistent with the requirements in Article IX, Florida-friendly Use of Fertilizer on Urban Landscapes, of [Chapter 42 of the Escambia County Code of Ordinances](#).
- All commercial fertilizer applicators that apply fertilizers within the development shall have been trained in the [Florida Green Industry BMP Program](#) as required in Section [403.9338, F.S.](#), and certified pursuant to the requirements in [Section 482.1562, F.S.](#)
- The publication entitled *Do-It-Yourself Guide to Florida-friendly Fertilizing* shall be provided to each new buyer within the development.

SC7. Rainfall Interceptor Trees

1. Description

Interceptor trees are trees used in urban land uses adjacent to impervious surfaces as part of the stormwater treatment system to reduce runoff volume and pollution. Trees intercept stormwater and retain a significant volume of the captured water on their leaves and branches allowing for evaporation and providing runoff volume reduction benefits. For example, a large oak tree can intercept and retain more than 500 to 1,000 gallons of rainfall in a given year (Cappiella, 2004). While the most effective Interceptor Trees are large canopied evergreen trees, deciduous trees can also provide a benefit. For example, a leafless Bradford pear will retain more than one half the amount of precipitation intercepted by an evergreen cork oak (Xiao et al., 2000). Interceptor trees are an important component of urban reforestation and therefore also help to reduce the heat island effect.



INTERCEPTOR TREES SUMMARY

Advantages/Benefits	Reduces stormwater volume by intercepting rainfall and preventing it from hitting impervious surfaces; reduces heat island effect; reduces potable water use and reuses stormwater for irrigation; can be used within parking lot islands; can be used for new trees or existing trees. Interceptor trees also provide for enhanced aesthetic value, provides shade to cool pavement and reduces surface runoff temperatures, aids in removal of air pollutants and noise reduction, and provides potential LEED Credits.
Disadvantages/Limitations	Trees must be within 15 feet of impervious area; must provide adequate uncompacted and aerated soils for tree survival.
Volume Reduction Potential	Low to Moderate depending on number of trees and canopy cover of impervious surfaces.
Pollutant Removal Potential	Low to Moderate, directly related to reduction in stormwater volume.
Key design considerations	Determine locations for trees; select or protect desired tree species; ensure at least 1,000 cubic feet of uncompacted soil volume per tree;

Key construction and maintenance considerations	Prevent soil compaction and contamination from construction related materials; plant trees following guidelines; protect existing trees with proper barriers; install irrigation per specification' mulch with hardwood chips; prune trees as needed; replace mulch as needed.
---	--

2. Applicability and Siting Considerations

- **Soils:** Drainage and soil type must support selected tree species. Must have sufficient soil volume to allow a tree to grow to its mature size. In general, a large-sized tree (16 inches in diameter) needs at least 1,000 cubic feet of uncompacted soil.
- **Location:** Locate within an impervious surface (such as in landscape islands within parking lots or tree planters within plazas) or within 15 feet of an impervious surface (as close as practical depending on the tree species).
- **Other structures:** Maintain appropriate distance from infrastructure and structures that could be damaged by roots and avoid overhead power lines, underground utilities, septic systems, sidewalks, curbs, patios, etc. Root deterrents such as #57 stone can be use.
- **Advantages:** Interceptor trees reduces the volume of rainfall that land on impervious surfaces and become stormwater. This reduces the total stormwater volume and the stormwater pollutant loading entering the storm drain system and can reduce the size of downstream stormwater systems.

3. Stormwater Treatment Credits

The basic stormwater treatment mechanism associated with interceptor trees is the reduction in stormwater volume associated with the interception of the rainfall by the trees. The credits set forth below are based on the research conducted by New College in Sarasota County during 2006 to document rainfall interception by oaks, pines, and palm trees (Final report, NOAA Award NA03NMF4720538) and an interpretation of the data undertaken by the Sarasota County project manager. Based on this study, a provisional rainfall interception value is established below:

TREE TYPES	NEW TREES INTERCEPTION CREDIT*	EXISTING TREES INTERCEPTION CREDIT*
Oaks or similar species	.13	.18
Pines or similar species	.10	.15
Palms or similar species	.08	.13

* Interception credit is equal to the fraction of the annual average rainfall volume that is intercepted by the tree and prevented from becoming stormwater on a DCIA.

The volume, TN, and TP load reduction credits **associated with new interceptor trees** is calculated as follows:

- Determine the impervious surface area that the canopy of the tree(s) will cover in 20 years.
- From the above table, select the appropriate interception credit by tree type
- Calculate the average annual rainfall volume reduction

$$V = A * R * I * \text{Conversion}$$

Where:

- V = average annual rainfall interception (reduction) in cubic feet (ft³)
- A = impervious area covered by tree canopy in square feet (ft²)
- R = average annual rainfall in inches (in)
- I = interception credit in fraction of average annual rainfall

Conversion = 1 ft/12 inches = 0.083

Area (in ft²) * Annual rainfall (in/yr)* Interception Credit (fraction)* Conversion factor (1 ft/12 inches) = Volume in cubic feet

- Apply a safety factor of two to the volume or divide the annual rainfall volume reduction by 2.
- Calculate TN and TP load reductions by multiplying the volume times the EMCs listed in Table 4.4

Load reduction LBs = Volume (ft³) * EMC (mg/l) * (7.48 gal/ft³) * (3.785 l/gal)(1 lb/453592)

To calculate the load reduction credit when **existing trees are used for interception trees**, follow the above process but do not apply a safety factor of 2.

Since only one Florida study is available for Interceptor Trees, it is considered a provisional BMP. However, because the level of treatment required by this Manual is the same as required by the NFWFMD, the Interceptor Tree load reduction credit is not available to use. Readers interested in more information about Interceptor Trees, including detailed design criteria, are directed to the recently adopted [Pinellas County Stormwater Treatment Manual](#).

SC8. Install Efficient Irrigation Systems

In 2004, the Florida legislature created section 373.228, Florida Statutes, directing the Department of Environmental Protection, the Water Management Districts, and several stakeholder groups to devise standards for Landscape Irrigation and Florida-Friendly landscape design. These standards were adopted in December 2006 and they are available online at: <http://www.dep.state.fl.us/water/waterpolicy/docs/LandscapeIrrigationFloridaFriendlyDesign.pdf>.

Local governments must use these standards when adopting local ordinances after that date. The irrigation standards are based on Appendix F of the Florida Building code.

When irrigation is necessary, use water conserving, low flow, programmable, and/or targeted irrigation systems. Landscaping beds with shrubs should be on separate zones from turf, and drip irrigation is recommended. If native plants are used, irrigation may be removed or turned off after they are well established, approximately one year. Many different types of irrigators are available.

Consider which is most efficient for each application. To maximize irrigation efficiency of automatic in-ground irrigation systems, consider smart water application technologies such as evapotranspiration (ET) controllers or soil moisture



sensors (SMS).

When using soil moisture sensors, the run time for each irrigation zone can be divided into several short cycles, allowing the moisture level to be checked between cycles to optimize the amount of water delivered



SC9. Use Non-Potable Water Supply for Irrigation

Incorporate non-potable water as the primary source for irrigation: reclaimed water, roof runoff stored in rain barrels, underground vaults, or cisterns, or [harvested](#)

[stormwater](#). At the lot level, consider [rainwater harvesting](#) with cisterns or rain barrels for subsequent use to irrigate landscapes. While the relatively small volume stored in rain barrels will not measurably reduce stormwater from the site, they may be sufficient for irrigating small garden areas and may increase occupant's awareness of water use and promote conservation.

SC10. Community and Homeowner Education

All community developments should include a community or homeowner education program. This is especially true for developments that incorporate LID BMPs into their stormwater treatment train. The town of Harmony provides one example education program. Seven different signs are placed in public areas to inform residents about natural resources, with panels that can be easily changed as desired to teach about different issues. A website for residents gives wide ranging information, including water and energy efficiency, native landscaping, conservation of resources, waste reduction and local wildlife identification (<http://harmonyfl.com>.) Also, information brochures are given to prospective and new homeowners to introduce them to the community, its resources and efforts to protect natural resources.

5.3. Structural Stormwater BMPs

The rest of this chapter of the Escambia County Low Impact Design Manual provides detailed information on structural stormwater BMPs. This includes:

- [Section 5.3.](#) Retention basin
- [Section 5.4.](#) Exfiltration trench
- [Section 5.5.](#) Underground storage and retention
- [Section 5.6.](#) Rain gardens (Bioretention)
- [Section 5.7.](#) Treatment swales
- [Section 5.8.](#) Vegetated natural buffers
- [Section 5.9.](#) Pervious pavements
- [Section 5.10.](#) Green roofs with cisterns
- [Section 5.11.](#) Rainwater harvesting systems
- [Section 5.12.](#) Stormwater harvesting
- [Section 5.13.](#) Up-flow filter systems
- [Section 5.14.](#) Managed aquatic plant systems
- [Section 5.15.](#) Biofiltration systems

For retention BMPs, remember that Table A1-1 and Table A1-2 are located in [Appendix A](#).

Use [Table A1-1](#) to determine the treatment volume needed to achieve an 80% pollutant load reduction if retention systems are being used to fully achieve the required level of pollutant load reduction.

If retention basins are being used as part of a BMP treatment train to achieve some level of pollutant load reduction but not the total amount of the required nutrient load reduction, use [Table A2-1](#).

5.3. Retention Basin Design Criteria

5.3.1. Description

A “retention basin” is a recessed area within the landscape that is designed to store and retain a defined quantity of runoff, allowing it to percolate through permeable soils into the shallow ground water aquifer. This section discusses the requirements for retention systems, historically referred to as “dry retention basins”, which are constructed or natural depression areas, often integrated into a site’s landscaping, where the bottom is typically flat, and turf, natural ground covers or other appropriate vegetative or other methods are used to promote infiltration, prevent clogging, and stabilize the basin bottom and slopes (see Figure 5.3.1).

Small retention basins that serve small drainage areas and that are integrated into the landscape plan, such as for the edge of property and parking lot islands, are called “Rain Garden or “Bioretention Areas”. These are a separate type of retention basin and they are further discussed in [Section 5.6](#).

Soil permeability and water table conditions are essential to successful use of retention basins so they can percolate the required treatment runoff volume within a specified time following a storm event. After drawdown has been completed, the basin does not hold any water, thus the system is normally “dry.” Unlike detention basins, the treatment volume for retention systems is not discharged to surface waters.

Retention basins provide numerous benefits, including reducing stormwater volume, which reduces the average annual pollutant loading that may be discharged from the system. Additionally, many stormwater pollutants such as suspended solids, oxygen demanding materials, heavy metals, bacteria, some varieties of pesticides, and nutrients are removed as runoff percolates through the soil profile.

RETENTION BASIN SUMMARY

Advantages/Benefits	Reduces stormwater volume, peak discharge rate, pollutant loadings, and heat island effect. Provides ground water recharge and enhanced site aesthetics.
Disadvantages/Limitations	Can require large footprint. Do not construct within 75 feet of a public or private potable water supply well or within 15 feet of an onsite wastewater disposal and treatment system. Site must have appropriate soil and SHGWT conditions for infiltration. Not appropriate on sites with potential hazardous or toxic materials.
Volume Reduction Potential	High
Pollutant Removal Potential	High for all pollutants, removal is directly related to the annual percent of stormwater retained and not discharged
Key design considerations	SHGWT at least 2 feet below bottom; recovery of treatment volume within 24 – 72 hours; sides and bottoms must be stabilized with vegetation or other approved materials
Key construction and maintenance considerations	Minimize soil compaction and sedimentation during construction; ensure design infiltration is met after construction; inspect during wet season to see if water is ponding and not infiltrating properly; restore infiltration capacity as needed to meet permit requirements

To accomplish the desired level of pollutant load reduction, retention basins shall be designed in accordance with the following design and performance criteria.

Figure 5.3.1. Typical Cross-section of “Dry” Retention Basin

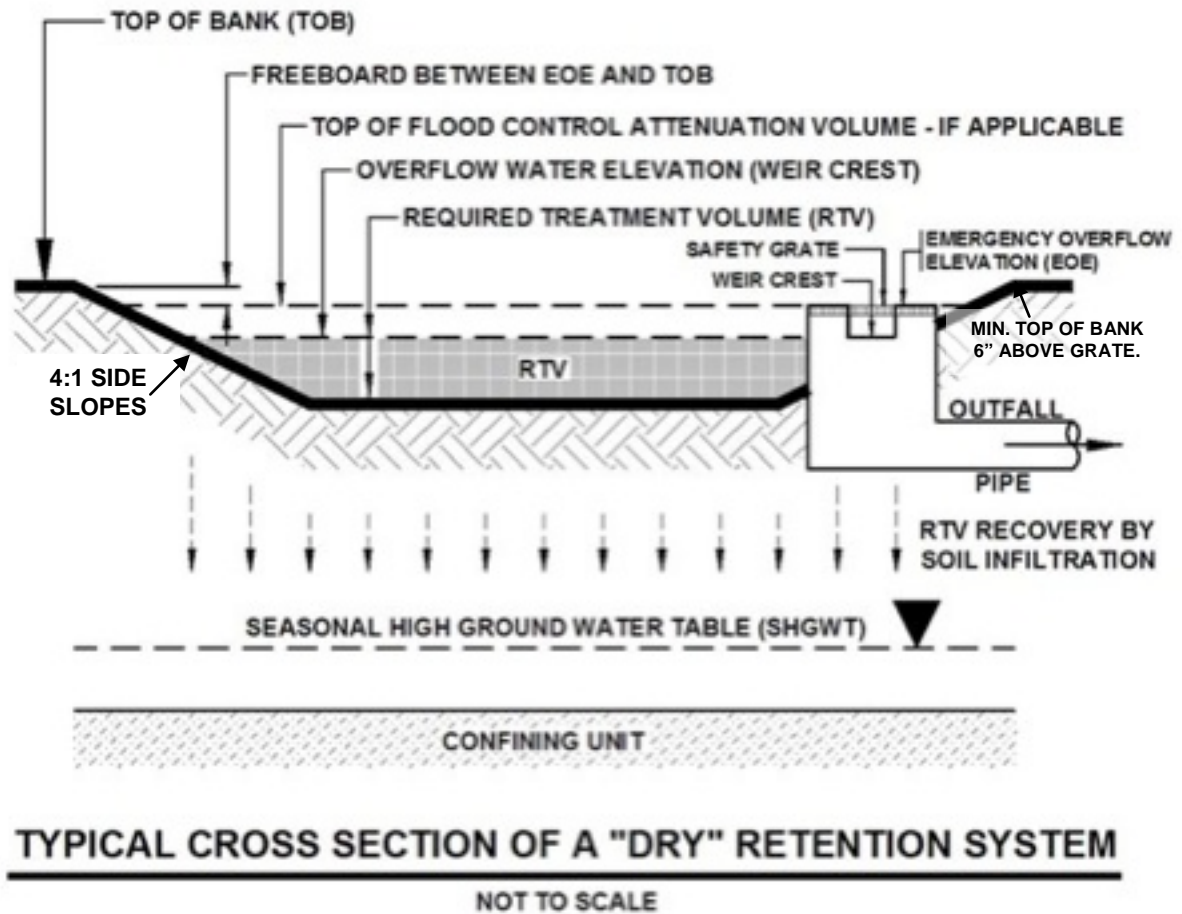

5.3.2. Required Treatment Level and Associated Treatment Volume

The Required Treatment Volume (RTV) necessary to achieve the desired treatment efficiency shall be routed to the retention basin and percolated into the ground. The required nutrient load reduction will be determined by the applicable Performance Standard in [Section 4.3](#), or by the NFWFMD ERP requirements. The RTV specified in the NFWFMD Applicant’s Handbook is:

- Off-line retention of the first one-half inch of runoff from the contributing area; or
- On-line retention of the runoff from one inch of rainfall over the contributing area. A minimum volume of one-half inch of runoff from the contributing area is required.
- For direct discharges to OFWs, the applicant shall provide retention for an additional fifty percent of the applicable treatment volume specified above.

Note that in [Table A2-1](#) if the RTV is one-half inch the average annual load reduction varies from 38.1% to 91.8% depending on the percent DCIA and the non-DCIA curve number.

For those projects within the sub-watersheds of Verified Impaired Waters or water bodies with an adopted TMDL, use **Table A2-1** to determine the treatment volumes to achieve a variety of load reduction efficiencies based on the percentage of directly connected impervious area (DCIA) and the weighted curve number for non-DCIA areas.

5.3.3. Calculating Load Reduction Efficiency for a Given Retention Volume

Use [Table A1-1](#) to determine the treatment volume needed to achieve an 80% pollutant load reduction if retention systems are being used to fully achieve the required level of pollutant load reduction.

If retention basins are being used as part of a BMP treatment train to achieve some level of pollutant load reduction but not the total amount of the required nutrient load reduction, use [Table A2-1](#).

5.3.4. Design Criteria

1. The retention basin must have the capacity to retain the required treatment volume without a discharge and without considering soil storage.
2. The retention basin must recover the required treatment volume of stormwater within 72 hours assuming average Antecedent Runoff Condition (ARC 2). Vegetated systems need to recover the required treatment volume within 24 to 36 hours to prevent damage to the vegetation. A recovery analysis is required that accounts for the mounding of ground water beneath the retention basin. Requirements related to safety factors, mounding analysis and supporting soil testing is provided in [Appendix B](#) of this Manual.
3. The seasonal high ground water table shall be at least two feet beneath the bottom of the retention basin unless the applicant demonstrates, based on plans, test results, calculations or other information, that an alternative design is appropriate for the specific site conditions.
4. The retention basin sides and bottom shall be stabilized with permanent vegetative cover, some other pervious material, or other methods acceptable to the County that will prevent erosion and sedimentation. Vegetation shall not be muck grown sod.
5. Retention basins shall not be constructed within 75 feet of a public or private potable water supply well or within 15 feet of an onsite wastewater disposal and treatment system.
6. The top bank of a retention basin shall not be within 5-ft of the right-of-way.

5.3.5. Required Site Information

Successful design of a retention system depends greatly upon knowing conditions at the site, especially information about the soil, geology, and water table conditions. Specific data and analyses required for the design of a retention system including details related to safety factors, mounding analyses, and required soil testing are set forth in [Appendix B](#) of this Manual.

5.3.6. Retention Basin Construction

Retention basin construction procedures and the overall sequence of site construction are two key factors that can control the effectiveness of retention basins. The applicant must demonstrate that the design infiltration rate will be met after construction by minimizing soil compaction during construction and minimizing the amount of sediment deposited into the retention basin.

Because [stormwater management systems](#) are required to be constructed during the initial phases of site development, retention basins are often exposed to poor quality surface runoff. Stormwater runoff during construction contains considerable amounts of suspended solids, organics, clays, silts, trash and other undesirable materials. For example, the subgrade stabilization material used during construction of roadways and pavement areas typically consists of clayey sand or soil cement. If a storm occurs when these materials are exposed (prior to placement of the roadway wearing surface), considerable amounts of these materials end up in the stormwater conveyance system and the retention basin, hindering infiltration through the system. Another source of fine material generated during construction is disturbed

surface soil that can release large quantities of organics and other fine particles. Fine particles of clay, silt, and organics at the bottom of a retention basin also create a poor infiltrating surface.

The following construction procedures are required to avoid degradation of retention basin infiltration capacity due to construction practices:

- The location and dimensions of the retention basin shall be verified onsite prior to its construction. All design requirements including retention basin dimensions and distances to foundations, septic systems, wells, etc., need to be verified.
- The location of retention basins shall be clearly marked at the site to prevent unnecessary vehicular traffic across the area causing soil compaction.
- Initially construct the retention basin by excavating the basin bottom and sides to approximately 12 inches above final design grades.
- Excavation shall be done by lightweight equipment to minimize soil compaction. Tracked, cleated equipment does less soil compaction than equipment with tires.
- After the drainage area contributing to the basin has been fully stabilized, the interior side slopes and basin bottom shall be excavated to final design specifications. The excess soil and undesirable material must be carefully excavated and removed from the basin so that all accumulated silts, clays, organics, and other fine sediment material has been removed from the pond area. The excavated material shall be disposed of in a manner that assures it will not re-enter the retention basin.
- Once the basin has been excavated to final grade, the entire basin bottom must be deep raked and loosened for optimal infiltration. The depth to be raked is dependent on the type, weight and contact pressure of the construction equipment used during the bulk excavation of the basin.
- The retention basin must be stabilized with vegetation or other pervious materials.

An applicant may propose alternative construction procedures to assure that the design infiltration rate of the constructed and stabilized retention basin is met.

5.3.7. Inspections, Operation and Maintenance

Maintenance issues associated with retention basins are related to clogging of the porous soils, which reduces or prevents infiltration thereby slowing recovery of the stormwater treatment volume and often resulting in standing water. Sedimentation can cause clogging and resulting sealing of the bottom or side slope soils. It can also occur from excessive loading of oils and greases or from excessive algal or microorganism growth. Standing water within a retention basin can also result from an elevated high water table or from ground water mounding, both of which can present long term operational issues that may require redesign of the system.

To determine if an infiltration system is properly functioning or whether it needs maintenance requires that an inspection be done within 72 hours after a storm. The inspection should determine if the retention basin is recovering its storage volume within its permitted time frames, generally 24 to 72 hours after a storm. If this is not occurring and there is standing water, then the cause must be determined and actions undertaken beginning with those specified in the system's Operation and Maintenance Plan.

A. Inspection Items:

- Inspect basin for storage volume recovery within the permitted time set forth in [Section 5.3.4](#). Failure to percolate the required treatment volumes indicates reduction of the infiltration rate and a need to restore system permeability.
- Inspect and monitor sediment accumulation on the basin bottom or inflow to prevent clogging of the retention basin or the inflow pipes.

- Inspect vegetation of bottom and side slopes to assure it is healthy, maintaining coverage, and that no erosion is occurring within the retention basin.
 - Inspect inflow and outflow structures, trash racks, and other system components for accumulation of debris and trash that would cause clogging and adversely impact operation of the retention basin.
 - Inspect the retention basin for potential mosquito breeding areas such as where standing water occurs after 72 hours or where cattails, other invasive or nuisance vegetation becomes established.
- B. Maintenance Activities As-Needed To Prolong Service:
- If needed, restore the infiltration capacity of the retention basin so that it meets the permitted recovery time for the required treatment volume.
 - Remove accumulated sediment from retention basin bottom and inflow and outflow pipes and dispose of properly. Please note that stormwater sediment disposal may be regulated under [Chapter 62-701, F.A.C.](#) (Sediment removal should be done when the system is dry and when the sediments are cracking.)
 - Remove trash and debris from inflow and outflow structures, trash racks, and other system components to prevent clogging or impeding flow.
 - Maintain healthy vegetative cover to prevent erosion in the basin bottom, side slopes or around inflow and outflow structures. Vegetation roots also help to maintain soil permeability. Grass needs to be mowed and grass clippings removed from the basin to reduce internal nutrient loadings.
 - Eliminate mosquito-breeding habitats.
 - Assure that the contributing drainage area is stabilized and not a source of sediments.

5.4. Exfiltration Trench Design Criteria

5.4.1. Description

An exfiltration trench is a subsurface retention system consisting of a conduit such as perforated pipe surrounded by natural or artificial aggregate which temporarily stores and infiltrates stormwater runoff (Figure 5.4.1). Stormwater passes through the perforated pipe and infiltrates through the trench sides and bottom into the shallow ground water aquifer. The perforated pipe increases the storage available in the trench and helps promote infiltration by making delivery of the runoff more effective and evenly distributed over the length of the system.

Soil permeability and water table conditions must be such that the trench system can percolate the required stormwater runoff treatment volume within a specified time following a storm event. The trench system is returned to a normally “dry” condition when drawdown of the treatment volume is completed. Similar to retention basins, the treatment volume in exfiltration trench systems is not discharged to surface waters.

Like other types of retention systems, exfiltration trenches provide reduction of stormwater volume that reduces pollutant loads. Additionally, substantial amounts of suspended solids, oxygen demanding materials, heavy metals, bacteria, some varieties of pesticides and nutrients such as phosphorus may be removed as runoff percolates through the soil profile.

The operational life of an exfiltration trench depends on site conditions, system design, and maintenance. Pre-treatment BMPs such as swales or inlet protection BMPs are recommended to minimize maintenance issues. Sediment accumulation and clogging by fines can reduce the life of an exfiltration trench. Total replacement of the trench may be the only possible means of restoring the treatment capacity and recovery of the system. Periodic replacement of the trench should be considered routine operational maintenance when selecting this management practice. As such, exfiltration trenches must be located where replacement can readily occur. They shall not be placed within 10 feet of a building and must be designed with adequate accessibility for maintenance or trench replacement.

EXFILTRATION TRENCH SUMMARY

Advantages/Benefits	Reduces stormwater volume, peak discharge rate, pollutant loadings, and heat island effect. Provides ground water recharge and enhanced site development potential.
Disadvantages/Limitations	Only permitted for projects to be operated by entities with single owners or with full-time maintenance staff. Do not construct within 75 feet of a public or private potable water supply well or within 15 feet of an onsite wastewater disposal and treatment system. Site must have appropriate soil and SHGWT conditions for infiltration. Not appropriate on sites with potential hazardous or toxic materials.
Volume Reduction Potential	High
Pollutant Removal Potential	High for all pollutants, removal is directly related to the annual percent of stormwater retained and not discharged
Key design considerations	<u>SHGWT</u> at least 2 feet below bottom; recovery of treatment volume within 24 – 72 hours; pretreatment via swales or catch basins essential to prevent litter, trash, leaves, and other debris from entering exfiltration trench.

<p>Key construction and maintenance considerations</p>	<p>Minimize soil compaction and sedimentation during construction; block Inflows to the trench until the contributing drainage area is stabilized. ensure design infiltration is met after construction; inspect during wet season to see if water is ponding and not infiltrating properly; restore infiltration capacity as needed to meet permit requirements</p>
--	--

Figure 5.4.1. Cross-section of a “DRY” Exfiltration Trench (N.T.S.)

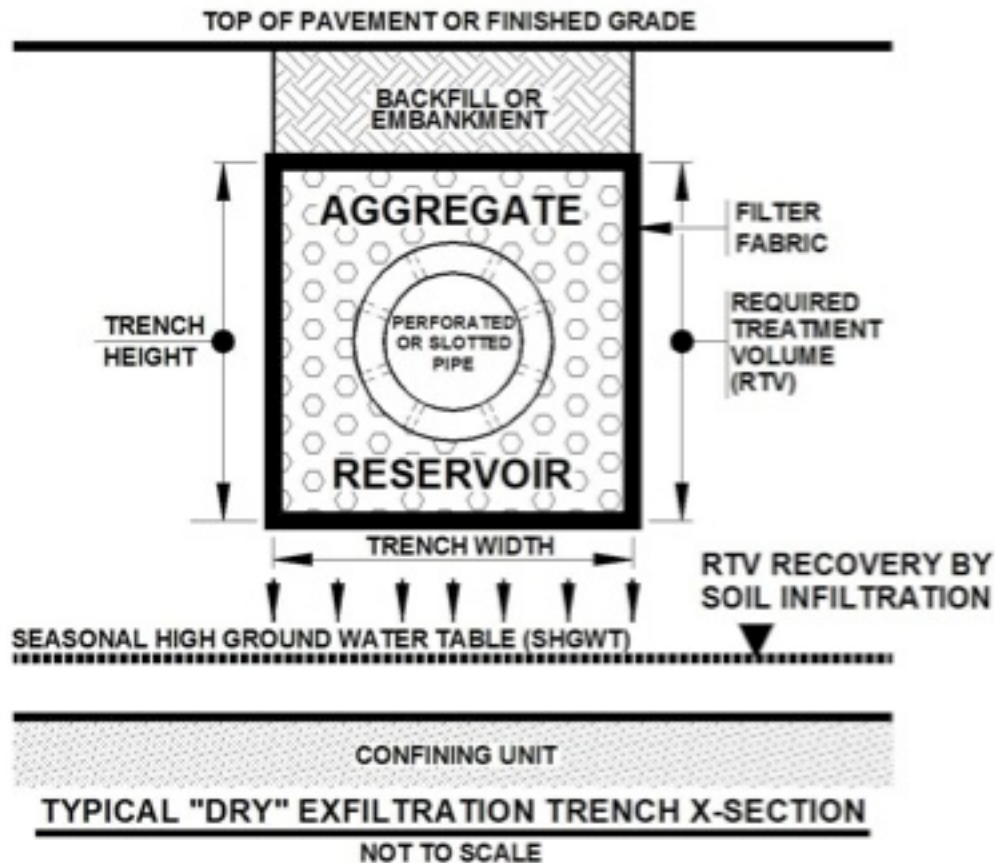

5.4.2. Required Level of Treatment and Associated Treatment Volume

The Required Treatment Volume (RTV) necessary to achieve the desired treatment efficiency shall be routed to the exfiltration trench and percolated into the ground. Refer to [Section 5.3.2](#) for the requirements that apply to retention BMPs.

5.4.3. Calculating Load Reduction Efficiency for a Given Retention Volume

Use [Table A1-1](#) to determine the treatment volume needed to achieve an 80% pollutant load reduction if exfiltration systems are being used to fully achieve the required level of pollutant load reduction.

If exfiltration systems are being used as part of a BMP treatment train to achieve some level of pollutant load reduction but not the total amount of the required nutrient load reduction, use [Table A2-1](#).

5.4.4. Design and Performance Criteria

1. Exfiltration trenches must have the capacity to retain the required treatment volume without a discharge and without considering soil storage.
2. The required treatment volume initially shall be retained in the perforated/slotted pipe and the surrounding aggregate reservoir.
3. Exfiltration trenches shall only be permitted for projects to be operated by entities with single owners or entities with full-time maintenance staffs.
4. The exfiltration trench must provide the capacity for the required treatment volume of stormwater within 72 hours, with a safety factor of two, following a storm event assuming average antecedent runoff condition (ARC 2). In exfiltration systems, the stormwater is drawn down by natural soil infiltration and dissipation into the ground water table as opposed to underdrain systems that rely on artificial methods such as drainage pipes. A recovery analysis is required that accounts for the mounding of ground water beneath the exfiltration system. Details related to safety factors, mounding analysis and supporting soil testing is provided in [Appendix B](#) of this Manual
5. Minimum perforated or slotted pipe diameter shall be twelve (12) inches. Pipe shall not exceed 45° bends.
6. Minimum aggregate reservoir trench width shall be three (3) feet.
7. To assure recovery of the Required Treatment Volume (RTV), a dry exfiltration trench must be designed so that the invert elevation of the trench is at least two feet above the seasonal high ground water table elevation unless the applicant demonstrates, based on plans, test results, calculations or other information, that an alternative design is appropriate for the specific site conditions. Refer to Figure 5.4.1 for additional information.
8. To prevent surrounding soil migration into the aggregate reservoir, the reservoir must be enclosed on all sides by a permeable woven or non-woven filter fabric. The permeability of the filter fabric must be greater than the permeability of the surrounding soil.
9. To facilitate inspection of proper operation and maintenance of the exfiltration system, the system must be designed with sufficient access for inspection. Appropriate inspection access is dependent on the design of the specific system, but all must provide the ability to determine whether the system is maintaining the design infiltration rate and storage volume. Examples of acceptable inspection methods include designing the system such that the terminal ends of any perforated/slotted pipe or storage areas either:
 - Terminating in an accessible drainage inlet or manhole; or
 - Having an eight (8) inch minimum diameter inspection port installed at any terminal “dead end” of any perforated/slotted pipe or storage areas. Sweep in end no greater than 45° bend and 300' in length.
 - Having an observation well that allows checking of the recovery of the RTV.
 - Refer to Figure 5.4.2 for additional information and recommendations.
10. To provide a collection space for trash and other inflow debris, a minimum 24-inch deep maintenance sump will be required for all system inlets and manholes. A minimum twelve-inch (12”) diameter weep hole shall be placed in the bottom of the maintenance sump to facilitate the infiltration of stormwater into the underlying soils after a rainfall event. Refer to Figure 5.4.2 for additional information and recommendations.
11. To reduce the potential for trash, debris and oil/grease inflow into the exfiltration trench system; a baffle, trash tee or other equivalent device must be installed at the end of the perforated/slotted pipe(s) in all access inlets and manholes. Refer to Figures 5.4.3 and 5.4.4 for additional information and recommendations.
12. Sustainable void spaces must be used in computing the storage volume in the aggregate reservoir. These aggregate void space values *shall be the greater* of the following:
 - 35% of aggregate volume; or

- 80% of the measured testing lab values for the selected aggregate(s), if obtained and certified by a Florida licensed geotechnical professional.
13. The material used in the aggregate reservoir shall be washed to assure that no more than five percent (5%) of the materials passing a #200 sieve.
14. Exfiltration trenches shall not be constructed within 75 feet of a public or private potable water supply well or within 15 feet of an onsite wastewater disposal and treatment system.

5.4.5. Required Site Information

Design of an exfiltration system must consider site conditions including soil, geology, and water table conditions. Specific data and analyses required for the design of retention BMPs, including an exfiltration trench are set in [Appendix B](#) of this Manual.

Figure 5.4.2. Typical Exfiltration Trench Sumps and Dead End Details

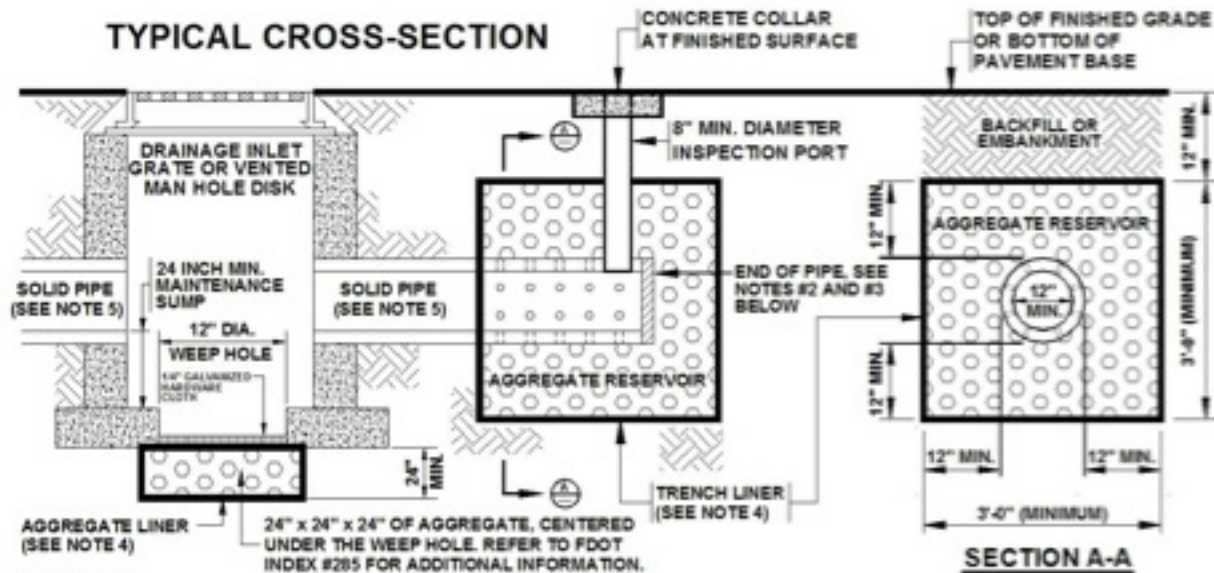

NOTES:

1. SEE THE SEPARATE DETAIL SKETCHES FOR SEDIMENT / TRASH BAFFLES & TEES, OR OTHER EQUIVALENT DEVICES.
2. PERFORATED OR SLOTTED PIPES SHALL TERMINATE A MINIMUM OF TWO (2) FEET FROM THE END OF THE EXFILTRATION TRENCH, OR CONNECT TO ADDITIONAL INLETS OR MANHOLES.
3. PIPE "DEAD ENDS" (IF UTILIZED) SHALL TERMINATE INTO A SOLID PLUG OR END CAP.
4. SIDES, TOP, BOTTOM, AND ENDS OF TRENCH (AND AGGREGATE BELOW DRAIN HOLE) SHALL BE LINED WITH A PERVIOUS WOVEN OR NON-WOVEN ENGINEERING FILTER FABRIC. OVERLAP FABRIC LINING MATERIAL A MINIMUM OF TWELVE (12) INCHES AT THE TOP OF THE AGGREGATE.
5. REFER TO FOOT INDEX #285 FOR ADDITIONAL INFORMATION ON THE MINIMUM LENGTHS OF SOLID PIPE EXITING THE ACCESS MANHOLE OR DRAINAGE INLET, AND THE MINIMUM CROSS SECTIONAL DIMENSIONS OF THE AGGREGATE RESERVOIR.

"GENERIC" EXFILTRATION TRENCH SUMPS & DEAD END DETAILS

NOT TO SCALE

Figure 5.4.3. Detail for Exfiltration Trench Trash Baffle

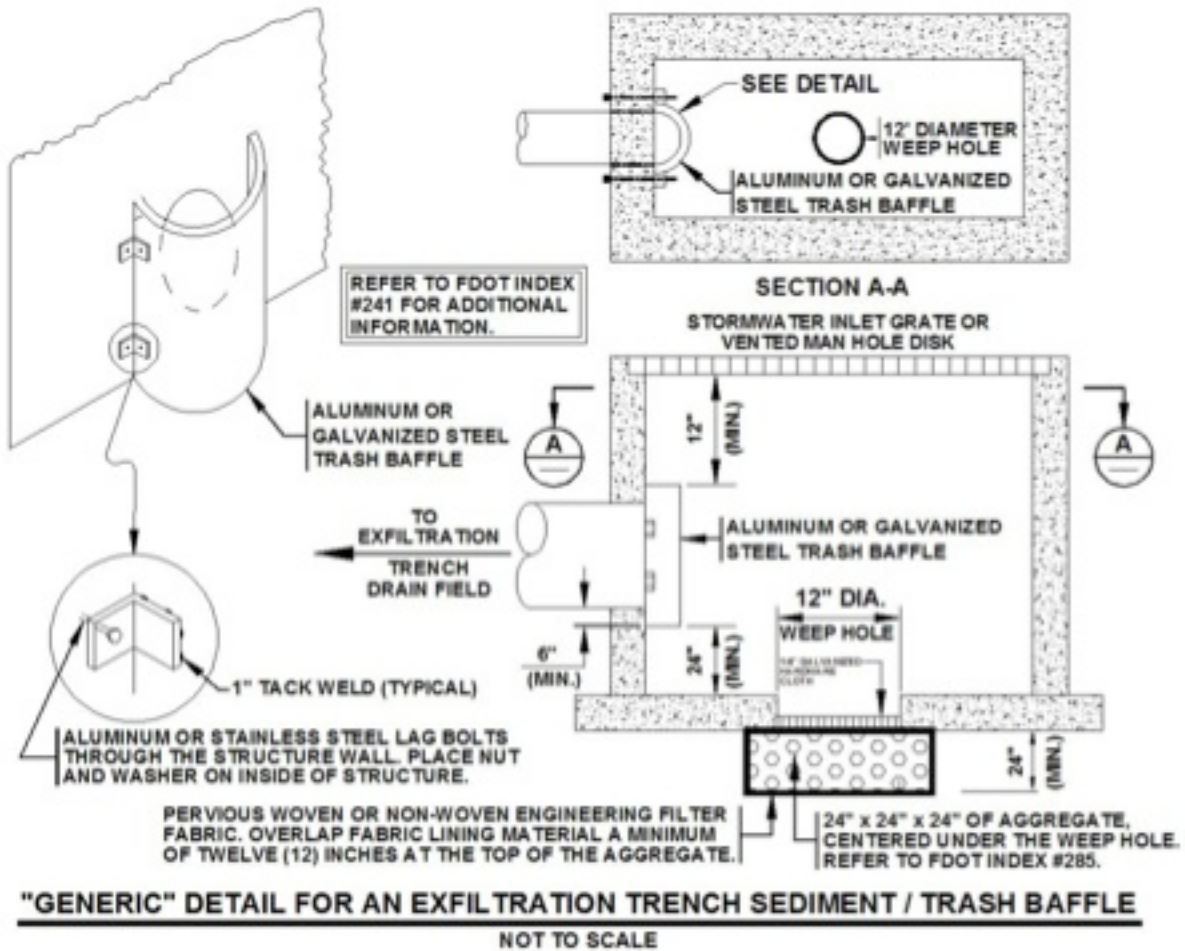
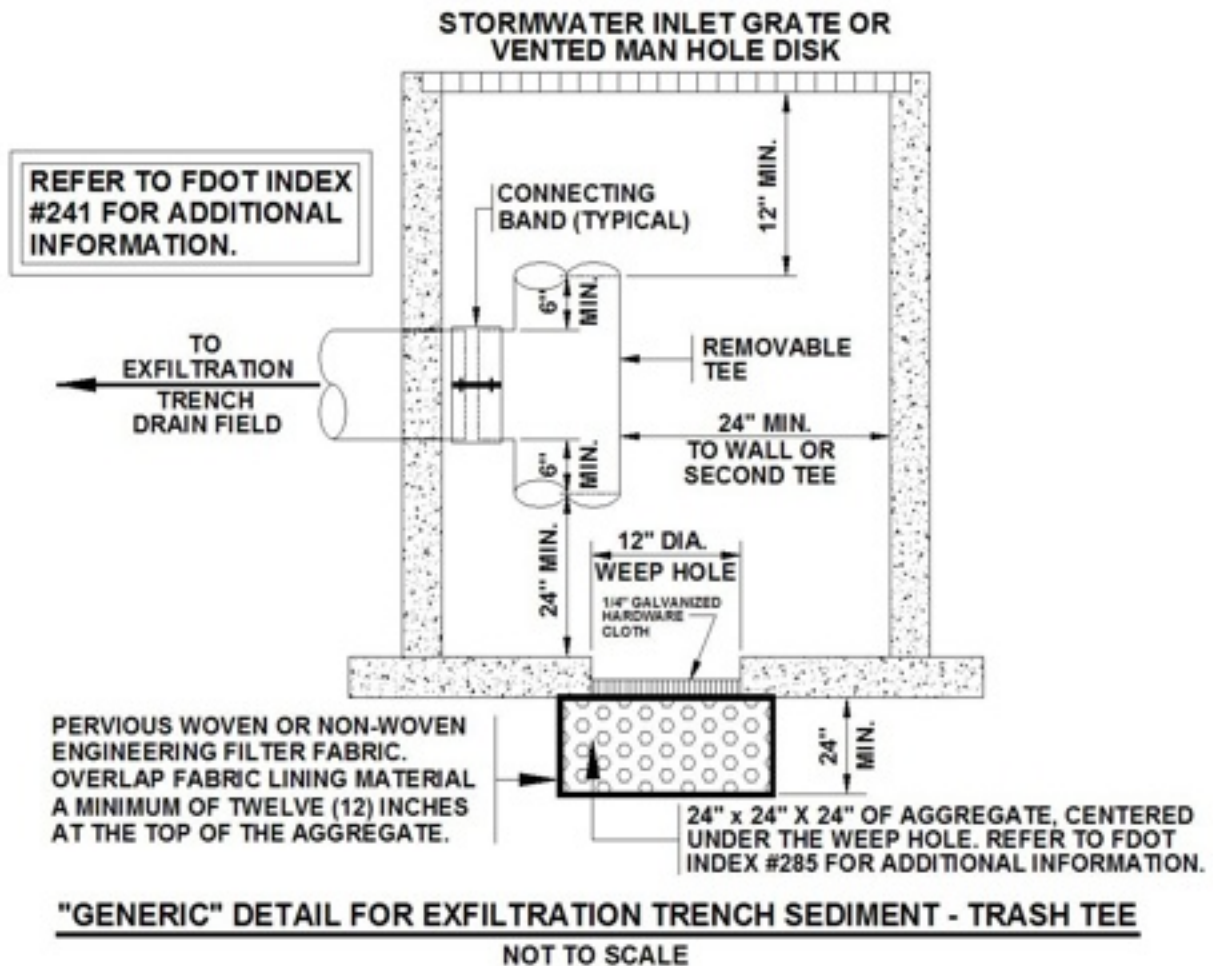

Figure 5.4.4. Generic Detail for a Typical Exfiltration Trench Trash Tee



5.4.6. Construction requirements

During construction, every effort should be made to limit the parent soil and debris from entering the trench. To extend the life of the system, use BMPs to reduce the amount of fine sediment entering the exfiltration trench during construction.

1. The location and dimensions of the exfiltration trench shall be verified onsite prior to trench construction. All design requirements including trench dimensions and distances to foundations, septic systems, wells, etc., need to be verified.
2. To minimize sealing of the soil surface, the trench shall be excavated with a backhoe rather than front-end loaders or bulldozers whose blades will seal the infiltration soil surface.
3. Excavated materials shall be placed a sufficient distance from the sides of the excavated area to minimize the risk of sidewall cave-ins and prevent the material from re-entering the trench.
4. The trench bottom and side walls shall be inspected for materials that could puncture or tear the filter fabric, such as tree roots, and assure they are not present.
5. The aggregate material shall be inspected prior to placement to ensure it meets size specifications and is washed to minimize fines and debris.
6. Inflows to the trench shall be temporarily blocked until the contributing drainage area is stabilized to prevent sediment from entering and clogging the trench.

7. An applicant may propose alternative construction procedures to assure that the permitted infiltration rate of the constructed exfiltration trench is met provided they are acceptable and approved by the County.

5.4.7. Inspections, Operation and Maintenance

A. Inspection Items:

- Monitor facility for sediment accumulation in the pipe (when used) and storage volume recovery (i.e., drawdown capacity). Observation wells and inspection ports should be checked following a storm event. Failure to percolate stored runoff to the design treatment volume level within 72 hours indicates binding of soil in the trench walls and/or clogging of geotextile wrap with fine solids. Reductions in storage volume due to sediment in the distribution pipe, also reduces efficiency. Minor maintenance measures can restore infiltration rates to acceptable levels short term. Major maintenance (total rehabilitation) is required to remove accumulated sediment in most cases or to restore recovery rate when minor measures are no longer effective or cannot be performed due to design configuration.
- Inspect appurtenances such as sedimentation and oil and grit separation traps or catch basins as well as diversion devices and overflow weirs when used. Diversion facilities and overflow weirs should be free of debris and ready for service. Sedimentation and oil/grit separators should be scheduled for cleaning when sediment depth approaches cleanout level. Cleanout levels should be established not less than 1 foot below the invert elevation of the chamber.

B. As-Needed To Prolong Service:

- Remove sediment from sediment or oil/grease traps, catch basin inlets, manholes, and other appurtenant structures and dispose of properly.
- Remove debris from the outfall or “Smart Box” (diversion device in the case of off-line facilities).
- Removal of sediment and cleaning of trench system. This process normally involves facilities with large pipes. Cleanout may be performed by suction hose and tank truck and/or by high-pressure jet washing.

C. As-Needed To Maintain the 72-Hour Exfiltration Rate:

- Periodic clean-out or rehabilitation of the system to remove any accumulated trash, sediment and other inflow debris and remediate any clogging of perforated pipes.
- Total replacement of the system. In some cases, the system may not be able to be rehabilitated sufficiently to restore the design storage and infiltration rate. In these cases, complete replacement of the system may be necessary. The applicant shall provide an estimate of the expected life expectancy of the exfiltration trench and an estimate of the cost to replace the trench.

5.5. Underground Storage and Retention Systems Design Criteria

5.5.1. Description

Underground storage and retention systems are retention systems that capture the Required Treatment Volume (RTV) in an underground storage system and “drainfield”. Examples include underground tanks or chambers, several that are commercially-available models. Generally, these systems consist of lightweight, high strength modular units with “open” bottoms to allow for soil infiltration (refer to Figure 5.5.1 below). These systems are sometimes used where land values are high, and the owner/applicant desires to minimize the potential loss of usable land with other types of retention Best Management Practices (BMPs). Underground retention systems are not intended to have human access for maintenance.

UNDERGROUND STORAGE AND RETENTION SUMMARY

Advantages/Benefits	Reduces stormwater volume, peak discharge rate, pollutant loadings, and heat island effect. Provides ground water recharge and enhanced site development potential.
Disadvantages/Limitations	Only permitted for projects to be operated by entities with single owners or with full-time maintenance staff. Do not construct within 75 feet of a public or private potable water supply well or within 15 feet of an onsite wastewater disposal and treatment system Site must have appropriate soil and SHGWT conditions for infiltration. Not appropriate on sites with potential hazardous or toxic materials.
Volume Reduction Potential	High
Pollutant Removal Potential	High for all pollutants, removal is directly related to the annual percent of stormwater retained and not discharged
Key design considerations	<u>SHGWT</u> at least 2 feet below bottom; recovery of treatment volume within 24 – 72 hours; pretreatment via swales or catch basins essential to prevent litter, trash, leaves, and other debris from entering exfiltration trench; a baffle, trash tee or other equivalent device must be installed at the end of the perforated/slotted pipe(s) in all access inlets and manholes
Key construction and maintenance considerations	Minimize soil compaction and sedimentation during construction; block Inflows to the system until the contributing drainage area is stabilized. Ensure design infiltration is met after construction; inspect during wet season to see if water is ponding and not infiltrating properly; restore infiltration capacity as needed to meet permit requirements

Figure 5.5.1. Generic Underground Retention System

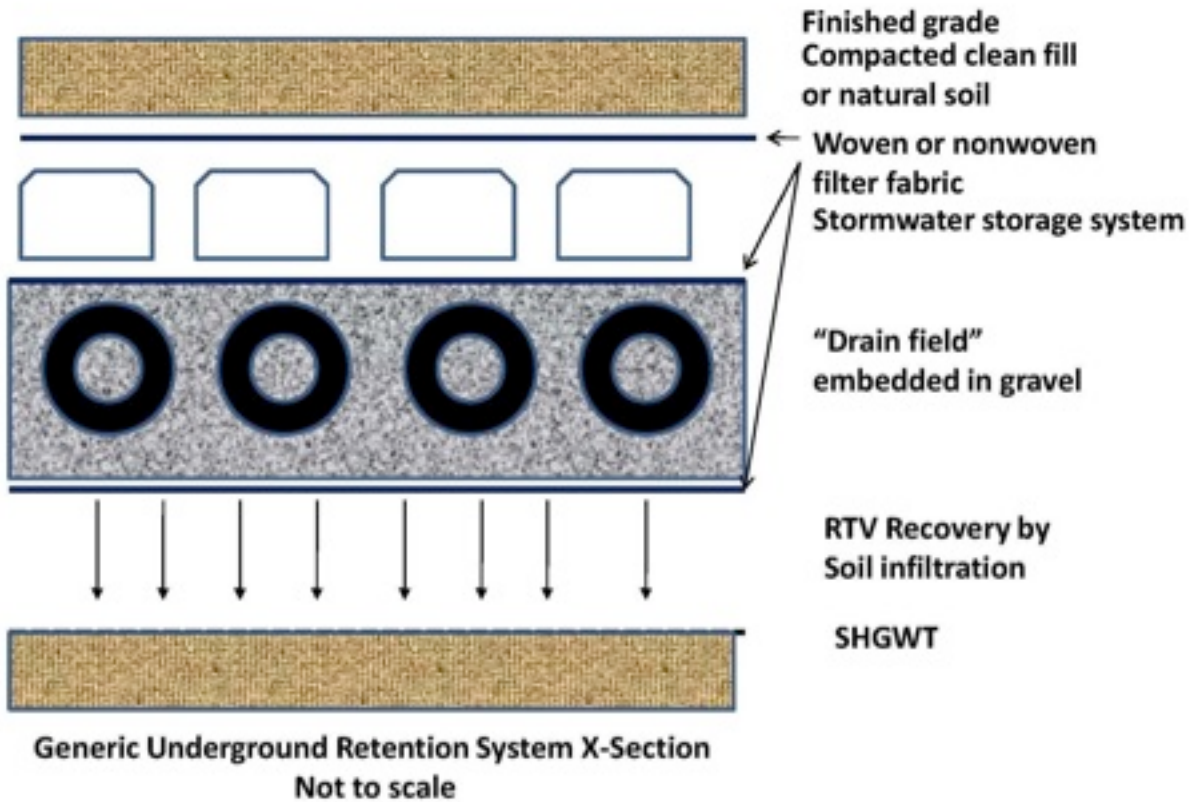

5.5.2. Required Treatment Volume

The Required Treatment Volume (RTV) necessary to achieve the desired treatment efficiency shall be routed to the underground retention system and percolated into the ground. Refer to [Section 5.3.2](#) for the requirements that apply to all retention BMPs.

5.5.3. Calculating Load Reduction Efficiency for a Given Retention Volume

Use [Table A1-1](#) to determine the treatment volume needed to achieve an 80% pollutant load reduction if underground retention systems are being used to fully achieve the required level of pollutant load reduction.

If underground retention basins are being used as part of a BMP treatment train to achieve some level of pollutant load reduction but not the total amount of the required nutrient load reduction, use [Table A2-1](#).

5.5.4. Design Criteria

1. The underground storage and retention system must have the capacity to retain the required treatment volume without a discharge and without considering soil storage.
2. The underground storage and retention system must recover the required treatment volume of stormwater within 72 hours, with a safety factor of two, assuming average Antecedent Runoff Condition (ARC 2). A recovery analysis is required that accounts for the mounding of ground water beneath the retention basin. Details related to safety factors, mounding analysis and supporting soil testing is provided in [Appendix B](#) of this Manual.

3. The seasonal high ground water table shall be at least two feet beneath the bottom of the underground storage and retention system.
4. Sustainable void spaces must be used in computing the storage volume in the aggregate reservoir. These aggregate void space values *shall be the greater* of the following:
 - 35% of aggregate volume; or
 - 80% of the measured testing lab values for the selected aggregate(s), if obtained and certified by a Florida licensed geotechnical professional.
5. Minimum perforated or slotted pipe diameter of twelve (12) inches.
6. Minimum aggregate reservoir trench width of three (3) feet.
7. To minimize the loss of the Required Treatment Volume (RTV), the underground retention system must be designed so that the invert elevation of the trench must be at least two feet above the seasonal high ground water table elevation unless the applicant demonstrates, based on plans, test results, calculations or other information, that an alternative design is appropriate for the specific site conditions.
8. To facilitate inspection/maintenance of the underground retention system, the terminal ends of the perforated/slotted pipe must either:
 - Terminate in an accessible drainage inlet or manhole;
 - Have an eight (8") inch minimum diameter inspection port installed at any terminal "dead end" of the perforated/slotted pipe; or
 - Have an observation well that allows checking of the recovery of the RTV.

Refer to [Figure 5.4.2](#) for additional information and recommendations. Alternatively, the applicant may propose a system that is manufactured with an equivalent functional component that would provide for inspection and maintenance.

9. To provide a collection space for trash and other inflow debris, a minimum 24-inch deep maintenance sump will be required for all system inlets and manholes. A minimum twelve inch (12") diameter weep hole shall be placed in the bottom of the maintenance sump to facilitate the infiltration of stormwater into the underlying soils after a rainfall event. Refer to [Figure 5.4.3](#) for additional information and recommendations. Alternatively, the applicant may propose a system that is manufactured with an equivalent functional component that would capture trash and other inflow debris and keep it out of the retention system.
10. To reduce the potential for trash, debris and oil/grease inflow into the underground retention system; a baffle, trash tee or other equivalent device must be installed at the end of the perforated/slotted pipe(s) in all access inlets and manholes. Refer to Figures 5.4.3 and [5.4.4](#) for additional information and recommendations. Alternatively, the applicant may propose a system that is manufactured with an equivalent functional component that would capture trash, debris, and oil/grease inflow into the underground retention system
11. The Required Treatment Volume (RTV) shall be initially retained in the perforated/slotted pipe and the surrounding aggregate reservoir.
12. Underground storage and retention systems shall not be constructed within 75 feet of a public or private potable water supply well or within 15 feet of an onsite wastewater disposal and treatment system.

5.5.5. Required Site Information

Design of an underground storage and retention system must carefully consider site conditions including soil, geology, and water table conditions. Specific data and analyses required for the design of an underground storage and retention system are set forth in [Appendix B](#).

5.5.6. Construction requirements

The following construction procedures are required to avoid degradation of underground retention system infiltration capacity due to construction practices:

1. The location of underground retention system shall be clearly marked at the site to prevent unnecessary vehicular traffic across the area causing soil compaction.
2. During construction, erosion and sediment controls shall be used to minimize the amount of soil, especially the amount of fine sediments, and debris entering the system.
3. During construction, inlet pipes shall be temporarily plugged, to prevent soil and debris from entering the system.
4. The underground retention system should not be placed into operation until the contributing drainage area is stabilized and the pretreatment sumps are constructed.

5.5.7. Inspections, Operation and Maintenance

1. General

Regular, routine inspection and maintenance is an important component of this type of underground system to ensure that it functions in a satisfactory manner. The maintenance intervals for an underground retention system are typically more frequent than standard “dry” retention ponds. The performance of the underground system will be related to the effectiveness of the up-gradient sediment/trash removal devices (refer to Figures 5.4.3 and 5.4.4), and the frequency of inspections and maintenance activities for all of the underground retention system’s components.

The guidelines outlined below are intended to provide a comprehensive schedule that gives reasonable assurance that the County requirements and recommendations are being met.

2. Indication of system failure:

Standing water over sub-grade soils at the bottom of the underground retention system 72 hours after a storm event typically indicates system failure. Long term system failures are generally the result of inadequate/improper O&M procedures within the up-gradient sediment / trash removal devices, and/or within the underground retention system itself.

3. Sub-grade Soil Maintenance

The sub-grade soils at the bottom of this system are the only mechanism to provide water quality treatment (soil infiltration of the RTV). Therefore, the designed hydraulic conductivity rates within this soil must be maintained. Inspection ports and access manholes/trench grates are provided to facilitate ongoing inspection and maintenance activities. Failure to repair inflow/outflow scour erosion damage, or to remove detrimental materials (i.e., trash, clays, lime rock debris, organic matter, etc.), will result in lower soil hydraulic conductivity rates, and subsequent system failure. Manual methods can be used for this required maintenance. However, the use of a vacuum truck for contaminate removal may be a more practical means of providing for the removal of these detrimental materials and sediments. Disposal of these contaminates shall be in an approved landfill facility.

4. Recommended inspection frequency

- *After a large storm event of greater than one (1) inch of rainfall:* To ensure the continued free flow of stormwater, inspect the system and remove accumulated trash and debris from the up-gradient sediment/trash removal devices, and the inflow and outflow points of the down-gradient underground retention system.
- *Every 6 months:* Perform a comprehensive inspection of the underground retention system for accumulated trash, debris and organic matter, and remove/dispose of these contaminates to ensure unimpeded stormwater flow. As appropriate, clean the surface of the sub-grade sands by raking, and check for accumulations in the various underground areas. If the sediment/contaminate accumulation is greater than two (2) inches, a vacuum truck and/or similar equipment may be necessary for removal operations. Removed contaminates shall be taken to an approved offsite landfill.

- *Annually, during September-November:* Monitoring of the drawdown time for the stormwater through the sub-grade sands shall be done to ensure recovery of the RTV within 72 hours after the last rainfall event. Monitoring and observation of the drawdown times can be done visually through the inspection ports or observation well after a storm event. If appropriate, post-construction hydraulic conductivity testing of the non-compacted soil floor shall be performed by the appropriate Florida licensed professional. Submit post-construction soil testing reports to the County.
 - Drawdown times that exceed 72 hours are indicative of sub-grade clogging, and will likely require the removal of contaminants and raking of the sub-grade soils. The actual depth of removal can be done visually by looking at the discoloration of the entrapped fine silts, hydrocarbons (greases, oils), and organic matter. If required, replacement sub-grade soils must meet the design specifications under the original permit authorization.
 - In addition to the sub-grade soils, other elements of the stormwater management system such as pipes, inlets, geotextile fabric, gravel, sediment/trash removal devices, etc., are to be inspected and repaired/replaced if needed.
5. Recommended Maintenance Activities
- Monitor facility for sediment accumulation in the pipe (when used) and storage volume recovery (i.e., drawdown capacity). Observation wells and inspection ports should be checked following a storm event. Failure to percolate stored runoff to the design treatment volume level within 72 hours indicates binding of soil within the system with fine solids. Reductions in storage volume due to sediment in the distribution pipe, also reduces efficiency. Minor maintenance measures can restore infiltration rates to acceptable levels short term. Major maintenance (total rehabilitation) is required to remove accumulated sediment in most cases or to restore recovery rate when minor measures are no longer effective or cannot be performed because of design configuration.
 - Inspect appurtenances such as sedimentation and oil and grit separation traps or catch basins as well as diversion devices and overflow weirs when used. Diversion facilities and overflow weirs should be free of debris and ready for service. Sedimentation and oil/grit separators should be scheduled for cleaning when sediment depth approaches cleanout level. Cleanout levels should be established not less than 1 foot below control elevation of the chamber.
6. As-Needed To Prolong Service:
- Remove sediment from sediment or oil/grease traps, catch basin inlets, manholes, and other appurtenant structures and dispose of properly.
 - Remove debris from the outfall or “Smart Box” (diversion device in the case of off-line facilities).
7. As-Needed To Maintain 72-Hour Infiltration Rate:
- Periodic clean-out/rehabilitation of the system to remove any accumulated trash, sediment and other inflow debris and remediate any clogging of perforated pipes, aggregates and geotextile fabrics.
 - Total replacement of the system. In some cases, the system may not be able to be rehabilitated sufficiently to restore the design storage and infiltration rate. In these cases, complete replacement of the system may be necessary. During replacement, any removed sediment, contaminated soil, coarse aggregate, and filter cloth shall be disposed of properly.

5.6. Rain Gardens (Bioretention Systems)

5.6.1. Description

Rain gardens are small retention basins that are integrated into a site’s landscaping. They also are called Bioretention Systems. A rain garden is a shallow, constructed depression that is planted with deep-rooted [Florida-Friendly](#) or native plants. It is located in the landscape or within parking lot islands to receive runoff from hard surfaces such as a roof, a sidewalk, a driveway, or parking area. Rain gardens slow down the rush of water from impervious surfaces, hold the water for a short period of time, and allow it to naturally infiltrate into the ground or evaporate. The combination of soil, microbes and vegetation provide filtration, sedimentation, adsorption, ion exchange of solids and metals as well as biological absorption and decomposition of organics and nutrients present in the stormwater.



Rain gardens have multiple functions. They recharge the local aquifer by increasing the amount of water that filters into the ground; reduce the amount of stormwater pollutants that enter storm sewers or nearby surface water bodies; provide habitat for birds, butterflies, and beneficial insects; and improve property value by adding curb appeal to the landscape. Rain gardens are a beautiful and colorful way for homeowners, businesses and municipalities to help ease stormwater pollution problems. They typically are planted with native plants, providing benefits to wildlife, aesthetic benefits to neighborhoods, increased property values, and psychological benefits of green spaces to urban residents. A rain garden also conserves municipal water resources by reducing the need for potable water irrigation.

If the soil is not permeable enough for retention, a second option is for the rain garden to be designed as a [biofiltration system](#) to function as a filter before water is conveyed downstream via an underdrain.

RAIN GARDEN (BIORETENTION) SUMMARY

Advantages/Benefits	Reduces stormwater volume and pollutant loadings; provides ground water recharge and enhanced site aesthetics; integrate into site’s landscaping.
Disadvantages/Limitations	Small contributing drainage area. Do not construct within 75 feet of a public or private potable water supply well or within 15 feet of an onsite wastewater disposal and treatment system. Site must have appropriate soil and SHGWT conditions for infiltration.
Volume Reduction Potential	Medium
Pollutant Removal	Medium for all pollutants, removal is directly related to the annual

Potential	percent of stormwater retained and not discharged but can be enhanced when soils are modified with BAM.
Key design considerations	SHGWT at least 2 feet below bottom; recovery of treatment volume within 24 – 72 hours; plant with Florida-Friendly plants appropriate for dry and wet conditions.
Key construction and maintenance considerations	Minimize soil compaction and sedimentation during construction; ensure design infiltration is met after construction; inspect during wet season to see if water is ponding and not infiltrating properly; restore mulch, remove weeds, and replant as necessary.

Figure 5.6.1. Typical Cross-Section of a Rain Garden

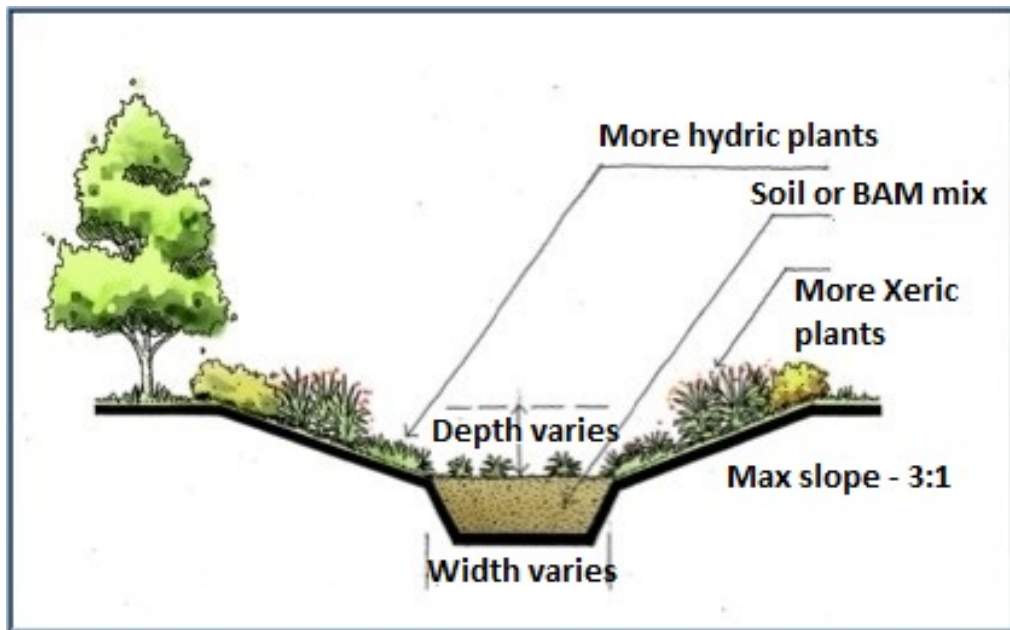

5.6.2. Required Treatment Volume

The Required Treatment Volume (RTV) necessary to achieve the desired treatment efficiency shall be routed to the rain garden and percolated into the ground. Refer to [Section 5.3.2](#) for the requirements that apply to all retention BMPs.

5.6.3. Calculating Load Reduction Efficiency for a Given Retention Volume

Use [Table A1-1](#) to determine the treatment volume needed to achieve an 80% pollutant load reduction if rain gardens are being used to fully achieve the required level of pollutant load reduction.

If rain gardens are being used as part of a BMP treatment train to achieve some level of pollutant load reduction but not the total amount of the required nutrient load reduction, use [Table A2-1](#).

5.6.4. Design Criteria

Follow the design criteria for Retention Basins in Section 5.3.4 and the following specific design criteria for rain gardens.

1. **Maximum contributing drainage area** - Rain gardens shall be used only when the contributing drainage area is less than 3 acres.
2. **Ponding depth** - Rain gardens shall have a minimum ponding depth of four inches and a maximum depth of 10 inches.
3. **Location** - Rain garden shall be at least 10 feet away from a structure to prevent seepage or flooding. Do not locate the garden over a septic field. Try to choose a naturally occurring low spot in the landscape or position the rain garden where gutter downspouts or sump pump outlet can be used to direct rainwater into the rain garden. Try to choose a location in the sun, either full or partial.
4. **Measure drainage area and treatment volume.** - Determine the contributing drainage area and its runoff characteristics, then use Table A2-1 to determine the treatment volume and associated load reduction.
5. **Topography** – Rain gardens are not recommended in areas where slopes are 10% or greater. Detailed engineering and geotechnical analysis must be completed prior to site clearing and implementation.
6. **Depth of Water Table** – Rain gardens are not suitable if there is less than 2 feet of separation between the seasonal high water table and the bottom of the rain garden, unless an alternative design can be shown to be appropriate for the specific site.
7. **Create a landscaping design** - Whether a rain garden is large or small the same basic principles apply. By planning the rain garden on paper first, one can create the best appearance possible for your rain garden.
8. **Choose the plants** – [Florida-friendly plants](#) are suggested for rain garden installations because they are best adapted for the area. Choose plants (flowers and grasses) that will grow well in both wet and dry areas because the rain garden will temporarily fill with rainwater from time to time. Rain gardens rely on plants that will survive dry spells but then soak up excess stormwater during Florida’s rainy months, preventing the water from running across your landscape. Include different types of plants in the rain garden to create a complete and cohesive look that will provide year-round interest. Suggested plants for Escambia County rain gardens are listed below; however, other plant species deemed appropriate may be used. If the rain garden is large enough, trees also may be used.

Suggested Rain Garden Plants for Escambia County		
	<i>Common Name</i>	<i>Botanical Name</i>
Flowers	African Iris	Dietes iridioides
	Blue Flag Iris*	Iris virginica
	Canna Lily	Canna spp.
	Goldenrod*	Solidago spp.
	Milkweed	Asclepias spp.
	Shrimp Plant	Justicia brandegeana
	Swamp Flower*	Helianthus angustifolius
Grasses & Shrubs	Florida gamma grass*	Tripsicum floridana
	Muhly grass*	Muhlenbergia capillaries
	Wiregrass*	Aristida stricta var. beyrichiana
	Virginia Willow*	Itea virginica

Ground Cover	Holly Fern	Cyrtomium falcatum
	Periwinkle	Vinca major
	St. Bernard's Lily	Anthericum sanderii
Notes: native plants designated by an asterisk (*)		

Figure 5.6.2. Schematic and Photo of Rain Garden

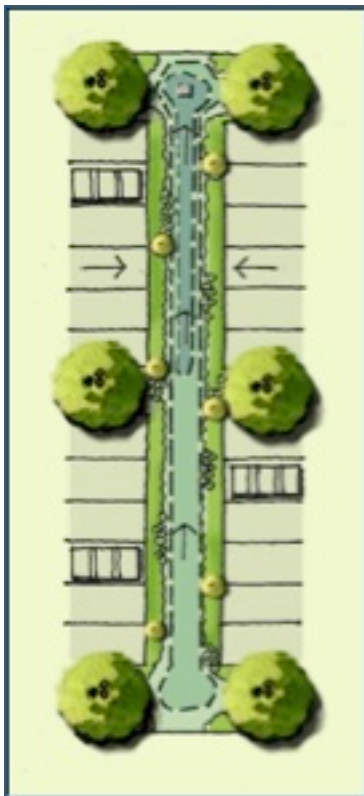

5.6.5. Construction of the Rain Garden

- Lay out the garden** - Lay out the shape and boundary of the rain garden based on the design. Before digging contact your local organization that locates underground utilities.
- Excavate the garden** - If appropriate, remove and reuse existing turf grass. Excavate to a depth of 18 to 24 inches. Use the soil to build a berm around the rain garden edges if necessary.
- Prepare the soil** - Install the desired soil/media mixture that is appropriate for the plants. Use of compost or [BAM](#) is optional. If used, mix in well.
- Plant the flowers and grasses** - Follow the approved design and install plants in the approximate positions. Step back and look at the garden and the design. Plants should be placed about 1 foot apart from each other.
- Mulch the garden** - Use coarse, fibrous, shredded woodchips that won't float or blow away. Apply the mulch about 2-3 inches deep. This will help to keep the moisture in and the weeds out. Avoid cypress mulch because it is made by chopping down rare, old-growth cypress in wetlands.

6. **Water and ensure conveyance inflow** - After the rain garden is planted, water every other day for 2 weeks if it doesn't rain until the garden looks to be growing on its own. Ensure that the conveyance system is delivering stormwater as desired and designed.

5.6.6. Inspection and Maintenance

1. Inspect rain gardens at the beginning and the end of each rainy season. Remember rain gardens are not completely maintenance-free. After the rain garden is planted and established it may seldom need watering except in the dry season and it should never need any type of fertilizer or pesticide.
2. The soil's infiltration capacity must be inspected after a rain event to determine whether the treatment volume is being recovered as designed. This is best done toward the end of the rainy season.
3. Inspect for any erosion and repair as necessary.
4. Remove accumulated sediment, trash, and other litter.
5. It is important to weed, clean-up and re-mulch the rain garden, as needed, in the early Spring and Fall. Remove invasive plants and other weeds. Check the health of desirable plants and replace if necessary. Trim or thin excessive plant growth and remove decaying plant material.
6. During the first growing season, the most important maintenance is watering and weeding. A young garden will need about an inch of water per week until it is established.
7. All rain gardens need constant weeding and replenishing of mulch. As the garden matures weeds will be pushed out by the growing plants. The mulch will need to be raked periodically and replenished or freshened every Spring.
8. Each Spring clean-up the rain garden by removing any dead material and replenishing the mulch. In the fall it is important to remove some of the dead vegetation. You might wish to leave some of the material and seed bearing plants for bird habitat in the winter however.

5.7. Vegetated Swales

5.7.1. Description

Swales have been used for conveyance of stormwater along roads for decades. However, swales can also be used for stormwater treatment when properly designed and maintained to provide retention and infiltration of stormwater, especially as part of a BMP Treatment Train.

Swales are defined in Chapter 403.803(14), Florida Statutes, as follows:

“Swale” means a manmade trench which:

- Has a top width to depth ratio of the cross-section equal to or greater than 6:1, or side slopes equal to or flatter than 3 feet horizontal to 1-foot vertical;
- Contains contiguous areas of standing or flowing water only following a rainfall event;
- Is planted with or has stabilized vegetation suitable for soil stabilization, stormwater treatment, and nutrient uptake; and
- Is designed to take into account the soil erodibility, soil percolation, slope, slope length, and drainage area so as to prevent erosion and reduce pollutant concentration of any discharge.”

Typically, swales are online retention systems and their treatment effectiveness is directly related to the amount of the annual stormwater volume that is infiltrated. Swales designed for stormwater treatment can be classified into three categories:

- Swales with swale blocks or raised driveway culverts (linear retention swales)
- Swales without swale blocks or raised driveway culverts (conveyance swales)
- Swales incorporated into landscaping (an elongated rain garden)

VEGETATED SWALE SUMMARY

Advantages/Benefits	Used as part of a BMP treatment train, sometimes for conveyance. Reduces stormwater volume, peak discharge rate, pollutant loadings, and heat island effect. Provides ground water recharge and enhanced site aesthetics. Can be integrated into the landscaping.
Disadvantages/Limitations	Do not construct within 75 feet of a public or private potable water supply well or within 15 feet of an onsite wastewater disposal and treatment system. Site must have appropriate soil and SHGWT conditions for infiltration. Not appropriate on sites with potential hazardous or toxic materials.
Volume Reduction Potential	Moderate to High depending on swale blocks
Pollutant Removal Potential	Moderate to High for all pollutants, removal is directly related to the annual percent of stormwater retained and not discharged.
Key design considerations	Minimum infiltration rate through the vegetation and soil is at least one inch per hour; SHGWT at least 2 feet below bottom; recovery of treatment volume within 24 – 72 hours; sides and bottoms must be stabilized with vegetation or other approved materials; bottom at least 2 feet wide for easier mowing.

<p>Key construction and maintenance considerations</p>	<p>Minimize soil compaction and sedimentation during construction; ensure design infiltration is met after construction; inspect during wet season to see if water is ponding and not infiltrating properly; restore infiltration capacity as needed to meet permit requirements</p>
--	--

Figure 5.7.1. Typical Cross-section of a Conveyance Swale without Swale Blocks

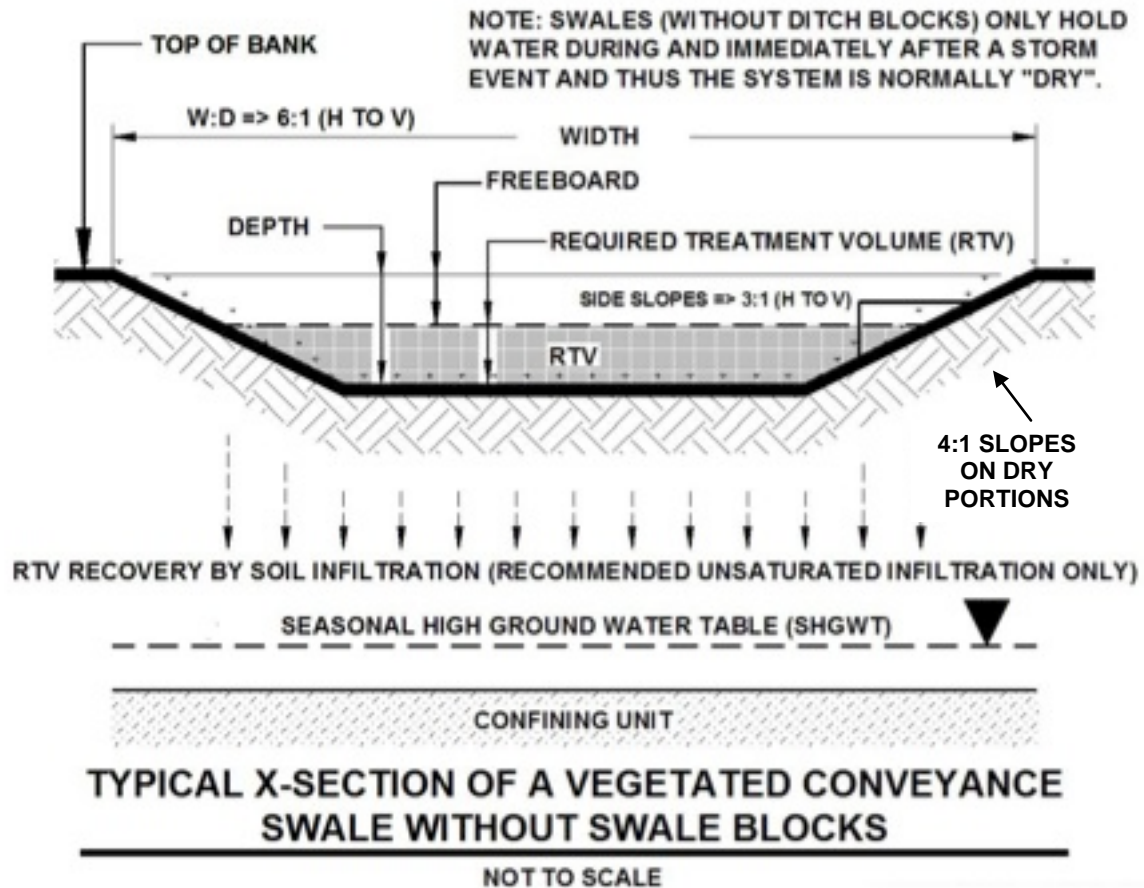

5.7.2. Swales with Swale Blocks or Raised Driveway Culverts (Linear Retention)

A swale with swale blocks or raised driveway culverts essentially is a linear retention system in which the treatment volume is retained and allowed to percolate. The treatment volume necessary to achieve the required treatment efficiency shall be routed to the swale and percolated into the ground before discharge. Linear retention swales are designed following the requirements for retention systems in [Section 5.3](#) and the design criteria specific to swales in [Section 5.7.7](#) of this Manual. This type of swale system is recommended when multiple inflows occur to a swale.



5.7.3. Swales without Swale Blocks or Raised Driveway Culverts (Conveyance Swales)

Conveyance swales are designed and constructed to properly convey and infiltrate stormwater runoff as it travels through the swale. Conveyance swales may be useable in some projects as part of a BMP treatment train to provide pre-treatment of runoff before its release into another BMP depending upon the site conditions, the location of inflows, and the land use plan. These swales are designed to infiltrate a defined quantity of runoff (the treatment volume) through the permeable soils of the swale floor and side slopes into the shallow ground water aquifer immediately following a storm event (Figure 5.7.1).



Turf or other acceptable vegetation is established to prevent erosion, promote infiltration and stabilize the bottom and side slopes. Soil permeability and water table conditions must be such that the swale can percolate the required runoff volume. The swale holds water only during and immediately after a storm event, thus the system is normally “dry.” These types of swales are “open” conveyance systems. This means there are no physical barriers such as swale blocks or raised driveway culverts to impound the runoff in the swale prior to discharge to the receiving water. In these types of swales, the inflow of stormwater occurs at the “top” of the swale system and the retention volume and associated stormwater treatment credit is based on the infiltration that occurs as the stormwater moves down the swale.

5.7.4. Required Treatment Volume for Conveyance Swales

The Required Treatment Volume (RTV) necessary to achieve the desired treatment efficiency shall be routed to the swale and percolated into the ground. The required nutrient load reduction will be determined by the applicable Performance Standard in [Section 4.3](#), or by the NFWFMD ERP requirements. The RTV specified in the NFWFMD Applicant’s Handbook is:

- For swale systems that discharge to Class III receiving water bodies, the swales shall be designed to percolate 80% of the runoff from the 3-year, 1-hour design storm during the storm event as influenced by the time of concentration, assuming average antecedent conditions.
- Swale systems that directly discharge to OFWs, shall be designed to percolate all of the runoff from the 3-year, 1-hour storm.
- Swale systems that incorporate swale blocks shall be designed to percolate the Required Treatment Volume as set forth in [Section 5.3.2](#).

5.7.5. Calculating Load Reduction Efficiency for a Given Retention Volume

Use [Table A1-1](#) to determine the treatment volume needed to achieve an 80% pollutant load reduction if linear retention swales are being used to fully achieve the required level of pollutant load reduction.

If linear retention swales are being used as part of a BMP treatment train to achieve some level of pollutant load reduction but not the total amount of the required nutrient load reduction, use [Table A2-1](#).

5.7.6. Calculating the Swale Length for Swales without Blocks

The average flow rate through the swale and the length of swale needed to percolate a given volume of stormwater can be calculated using the two equations below.

Equation 5.7.1. Calculating the average flow rate:

This is calculated using the rational formula with the peak rate divided by 2 (average of triangular hydrograph).

$$Q = 0.5 CIA \qquad \text{Equation 5.7.1}$$

Where:

Q = Average flow rate

C = runoff coefficient

i = rainfall intensity (inches/hour) for the time of concentration

A = area of the swale being used for infiltration

Equation 5.7.2. Swale length for Trapezoidal Shaped Swales

$$L = \frac{43,200 Q}{\left\{ B + 2 \left(\frac{\left(1.068 n Q (1 + Z^2)^{\frac{1}{3}} \right)}{S^{\frac{1}{2}} Z^{\frac{2}{3}} 2 [(1 + Z^2)^{\frac{1}{2}} - Z]} \right)^{\frac{3}{8}} (1 + S^2)^{\frac{1}{2}} \right\} i}$$

Where:

L = Length of swale (ft)

B = Bottom width of swale (ft)

Q = Average flow rate (cfs) from **Equation 5.7.1**

n = Manning’s Roughness Coefficient

Z = Side slope (horizontal distance for a one foot vertical change)

S = Longitudinal slope

i = Limiting infiltration rate of swale (inches/hour)

5.7.7. Design Criteria for Swales

1. Conveyance swales will be designed to infiltrate the required volume of stormwater needed to achieve the desired level of nutrient load reduction before discharging to the downstream BMP. Linear retention swales with swale blocks shall be designed to infiltrate the required treatment volume as for retention systems as specified in [Section 5.3.2](#) of this Manual.
2. The seasonal high ground water table shall be at least two feet below the bottom of the swale unless the applicant demonstrates based on plans, test results, calculations or other information that an alternative design is appropriate for the specific site conditions.
3. The minimum infiltration rate through the vegetation and soil shall be at least one inch per hour.
4. The lateral slope across the bottom of the swale shall be flat to assure even sheet flow and prevent channelized flow and erosion.
5. Longitudinal slopes shall not be so steep as to cause erosive flow velocities.

6. It is recommended that the bottom of the swale be at least two feet wide to facilitate mowing.
7. Off-street parking or other activities that can cause rutting or soil compaction is prohibited.
8. Swales shall not be constructed within 75 feet of a public or private potable water supply well or within 15 feet of an onsite wastewater disposal and treatment system.

5.7.8. Soil Requirements and Testing Requirements

Swales shall be constructed on Hydrologic Soil Group (HSG) A or B soils and swale system design shall consider antecedent moisture conditions. Geo-technical testing of the underlying soil will be required to establish the depth to the Seasonal High Ground Water Table (SHGWT), the limiting infiltration rate (constant rate with time), and identification of the location of close-to-surface impermeable materials or layers that may require re-location of the swale. Details related to safety factors, recovery/mounding analysis and supporting soil testing is provided in [Appendix B](#).

5.7.9. Construction and Stabilization Requirements

The following construction procedures are required to avoid degradation of the swale's infiltration capacity due to construction practices:

1. The location and dimensions of the swale system shall be verified onsite prior to its construction. All design requirements including swale dimensions and distances to foundations, septic systems, and wells need to be verified.
2. The location of swales shall be clearly marked at the site to prevent unnecessary vehicular traffic across the area causing soil compaction.
3. Excavation shall be done by lightweight equipment to minimize soil compaction. Tracked, cleated equipment does less soil compaction than equipment with tires.
4. Ensure that lateral and longitudinal slopes meet permitted design requirements and will not erode due to channelized flow or excessive flow rates.
5. Final grading and planting of the swale should not occur until the adjoining areas draining into the swale are stabilized. Any accumulation of sediments that does occur must be removed during the final stages of grading. The bottom should be tilled to produce a highly porous surface.
6. Ensure that measures are in place to divert runoff while vegetation is being established on the side slopes and bottom of the swale. If runoff can't be diverted, vegetation shall be established by staked sodding or by the use of erosion control blankets or other appropriate methods.
7. Ensure that the vegetation used in the swale is consistent with values used for Manning's "n" in the design calculations.
8. An applicant may propose alternative construction procedures to assure that the design infiltration rate of the constructed and stabilized swale system basin is met provided it is acceptable and approved by the County.

5.7.10. Inspections, Operation and Maintenance Requirements

Maintenance issues associated with swales primarily are related to clogging of the porous soils. This reduces or prevents infiltration thereby slowing recovery of the stormwater treatment volume and often resulting in standing water. Clogging can result from erosion and sedimentation and the resulting sealing of the bottom or side slope soils. It can also occur from excessive loading of oils and greases or from excessive algal or microorganism growth.

To determine if a swale is properly functioning or whether it needs maintenance requires an inspection be done during and soon after a storm. The inspection should determine if the swale is recovering its storage volume within its permitted time frames, generally 24 to 72 hours after a storm. If this is not occurring and results in standing water, then the cause of clogging must be

determined and appropriate actions undertaken beginning with those specified in the system's Operation and Maintenance Plan. Additionally, swales in areas with high SHGWT also will have standing water.

A. Inspection Items:

- Inspect swale for storage volume recovery within the permitted time, generally less than 72 hours. Failure to percolate the required treatment volumes indicates reduction of the infiltration rate and a need to restore system permeability
- Inspect and monitor sediment accumulation on the bottom of the swale or at inflows to prevent clogging of the swale or the inflow pipes.
- Inspect vegetation of bottom and side slopes to assure it is healthy, maintaining coverage, and that no erosion is occurring within the swale.
- Inspect the swale for potential mosquito breeding areas such as where standing water occurs after 72 hours or where cattails or other invasive vegetation becomes established.
- Inspect swale to determine if filling, excavation, construction of fences, or other objects are obstructing the surface water flow in the swales.
- Inspect the swale to determine if it has been damaged, whether by natural or human activities.

B. Maintenance Activities As-Needed To Prolong Service:

- If needed, restore infiltration capability of the swale to assure it meets permitted requirements.
- Remove accumulated sediment from swale and inflow or outflows and dispose of properly. Please note that stormwater sediment disposal may be regulated under [Chapter 62-701, F.A.C.](#) Sediment removal should be done when the swale is dry and when the sediments are cracking.
- Remove trash and debris, especially from inflow or outflow structures, to prevent clogging or impeding flow.
- Maintain healthy vegetative cover to prevent erosion of the swale bottom or side slopes. Mow grass as needed and remove grass clippings to reduce nutrient loadings.
- Eliminate mosquito-breeding habitats.
- Remove fences or other obstructions that may have been built in the swale system.
- Repair any damages to the swale system so that it meets permitted requirements.

5.8. Vegetated Natural Buffers

5.8.1. Description

Vegetated Natural Buffers (VNBs) are areas with natural vegetation suitable for sediment removal, nutrient uptake, and soil stabilization that are set aside between developed areas and a receiving water or wetland for stormwater treatment purposes. Typically, they are a [retention BMP](#). They also can be used as a prefilter for other BMPs. Under certain conditions, VNBs are an effective best management practice for the control of stormwater pollutants in overland flow by providing opportunities for filtration, deposition, infiltration, absorption, adsorption, decomposition, and volatilization.

VNBs are most commonly used as an alternative to swale/berm systems installed between backyards and the receiving water. Buffers are intended for use to avoid the difficulties associated with the construction and maintenance of backyard swales on land controlled by individual homeowners. Potential impacts to adjacent wetlands and upland natural areas are reduced because fill is not required to establish grades that direct stormwater flow from the back of the lot towards the front for collection in the primary stormwater management system. In addition, impacts are potentially reduced since buffer strips can serve as wildlife corridors, reduce noise, and reduce the potential for siltation into receiving waters.

Vegetative natural buffers are not intended to be the primary stormwater management system for residential developments. They are most commonly used only to treat those rear-lot portions of the development that cannot be feasibly routed to the system serving the roads and fronts of lots. A schematic of a typical VNB and its contributing area is presented in Figure 5.8.1. The use of a VNB in combination with a primary stormwater management system for other types of development shall only be allowed if the applicant demonstrates that there are no practical alternatives for those portions of the project, and only if the VNB and contributing areas meet all of the requirements in this section of the Manual.

VEGETATED NATURAL BUFFER SUMMARY

Advantages/Benefits	Reduces stormwater volume, pollutant loadings, and heat island effect. Provides ground water recharge and enhanced site aesthetics.
Disadvantages/Limitations	Used to treat rear roof and rear yard runoff, especially for waterfront lots. Do not construct within 75 feet of a public or private potable water supply well or within 15 feet of an onsite wastewater disposal and treatment system. Site must have appropriate soil and SHGWT conditions for infiltration.
Volume Reduction Potential	Low to Moderate depending on infiltration rate, site conditions, and flow length
Pollutant Removal Potential	Low to Moderate for all pollutants, removal is directly related to the annual percent of stormwater retained and not discharged.
Key design considerations	Legal reservation of the VNB required; must have shallow sheet flow; minimum width of 25 feet; minimum length equal to the length of the contributing runoff area with maximum length of 300 feet; minimum infiltration rate through the vegetation and soil is at least one inch per hour; SHGWT at least 2 feet below bottom; recovery of treatment volume within 24 – 72 hours; sides and bottoms must be stabilized with natural or Florida-Friendly vegetation

<p>Key construction and maintenance considerations</p>	<p>Minimize disturbance of vegetation during construction; ensure design infiltration is met after construction; inspect during wet season to see if water is ponding and not infiltrating properly; restore infiltration capacity as needed to meet permit requirements; maintain vegetation as necessary.</p>
--	---

Figure 5.8.1. Plan View Schematic of Typical Vegetative Natural Buffer



5.8.2. Required Treatment Volume

The Required Treatment Volume (RTV) necessary to achieve the desired treatment efficiency shall be routed to the vegetated natural buffer and percolated into the ground. However, the NWFWMD ERP design criteria do not include a RTV. Instead, they require:

- For systems that discharge to receiving water bodies other than OFWs, the VNB must be designed to provide at least 200 seconds of travel time by overland flow through the buffer for the 2-year, 24-hour storm event.
- Systems that directly discharge to OFWs must be designed to provide at least 300 seconds of travel time by overland flow through the buffer for the 2-year, 24-hour storm event.

Alternatively, a VNB can be designed with a RTV to be permitted as a retention BMP. In such cases, use the RTV in [Section 5.3.2](#). For those projects discharging to [impaired waters](#) or water bodies with an adopted [TMDL](#), use Tables A2-1 to determine the treatment volumes to achieve a variety of load reduction efficiencies based on the percentage of directly connected impervious area (DCIA) and the weighted curve number for non-DCIA areas.

5.8.3. Calculating Load Reduction Efficiency for a Given Retention Volume

Use [Table A1-1](#) to determine the treatment volume needed to achieve an 80% pollutant load reduction if underground retention systems are being used to fully achieve the required level of pollutant load reduction.

If underground retention basins are being used as part of a BMP treatment train to achieve some level of pollutant load reduction but not the total amount of the required nutrient load reduction, use [Table A2-1](#).

5.8.4. Design Criteria

1. Vegetated Natural Buffers shall be designed to infiltrate the required treatment volume as specified above or to meet the NFWFMD travel times.
2. The contributing area is defined as the area that drains to the VNB. Only rear-lots of residential areas are allowed to contribute runoff to a VNB and then only if routing the runoff from such areas to the primary [stormwater management system](#) serving the development is not practical.
3. The maximum width (dimension parallel to the flow direction) of the contributing area is 300 feet. No fertilizer shall be applied in the contributing area unless soil and leaf tissue analyses indicate a need for fertilizer to ensure healthy plant growth. Only [Florida-friendly fertilizers](#) shall be applied by certified commercial applicators.
4. The seasonal high ground water table shall be at least two feet below the bottom of the vegetated natural buffer unless the applicant demonstrates based on plans, test results, calculations or other information that an alternative design is appropriate for the specific site conditions.
5. The minimum infiltration rate through the vegetation and soil shall be at least one inch per hour.
6. The minimum buffer width (dimension parallel to flow direction) shall be 25 feet to provide adequate area for infiltration. The maximum VNB width shall be 100 feet to ensure sheet flow conditions and the integrity of the treatment system. Factors affecting the minimum width of the VNB include infiltration rate, ground slope, rainfall, cover and soil characteristics, depth to water table and overland flow length. Infiltration is the primary means of treatment in vegetated natural buffers
7. The maximum slope of VNB shall not be greater than 15%.
8. The length of the VNB (measured perpendicular to the runoff flow direction) must be at least as long as the length of the contributing runoff area (see Figure 5.8.1).
9. Runoff from the adjacent contributing area must be evenly distributed across the buffer strip to promote overland sheet flow. If the flow regime changes from overland to shallow concentrated flow, the buffer is effectively "short-circuited" and will not perform as designed.
10. The VNB area will be an existing undeveloped area that contains existing natural vegetation suitable for infiltrating stormwater and soil stabilization. The existing vegetation, except exotic species, must not be disturbed during or after the construction of the project. If the VNB requires some plantings, the proposed list of [Florida-friendly plants](#) must be submitted to the County for review. Maintenance shall assure that the VNB contains less than 10 percent coverage by exotic or nuisance plant species.

11. Erosion control measures as specified in Part IV of ERP [Applicant's Handbook Volume I](#) must be used during development of the contributing area so as to prevent erosion or sedimentation of the vegetated natural buffer.
12. Vegetated natural buffers shall not be constructed within 75 feet of a public or private potable water supply well or within 15 feet of an onsite wastewater disposal and treatment system.
13. The vegetated natural buffer and any required wetland buffer can be the same area provided that the functions and regulatory requirements for each are met.
14. The Property Association Documents and Conditions Covenants and Restrictions (CC&R's) will require that the contributing area must be stabilized with permanent vegetative cover that is consistent with the Florida-friendly Landscaping program and which is fertilized only with [Florida-friendly fertilizers](#) based on soil and leaf tissue testing.
15. A legal reservation, in the form of an easement or other limitation of use, must be recorded which provides preservation of entire area of the Vegetated Natural Buffer in its natural state. The reservation must also include access for maintenance of the VNB unless the operation and maintenance entity wholly owns or retains ownership of the property.

5.8.5. Required Site Information

Successful design of a Vegetated Natural Buffer system depends heavily upon conditions at the site, especially information about the soil, geology, and water table conditions. Specific data and analyses required for the design of a retention system are set forth in [Appendix B](#).

5.8.6. Construction Requirements

The following construction procedures are required to protect the Vegetated Natural Buffer during planting, if needed, and to avoid degradation of the VNB due to construction of the adjacent contributing area:

1. The location and dimensions of the VNB shall be verified onsite prior to any construction. All design requirements including VNB dimensions and distances to foundations, septic systems, wells, etc. need to be verified.
2. The VNB shall be clearly marked at the site to prevent equipment or vehicular traffic from entering the VNB (if a natural area) or to minimize compaction from any equipment entering the VNB during planting or establishment.
3. Ensure that the VNB buffer length, width, and slopes meet permitted design requirements.
4. Ensure that the VNB will not erode due to channelized flow or excessive flow rates.
5. Ensure that measures are in place to divert runoff from the VNB while the adjacent contributing area is being cleared and established. The adjacent contributing area shall be stabilized as quickly as possible by sodding or by the use of erosion control blankets or other appropriate methods.
6. Ensure that the natural vegetation in the VNB is healthy, that the adjacent contributing area meets Florida-friendly landscaping requirements, and that all exotic plants are removed as specified in the permitted design.

5.8.7. Inspections, Operation and Maintenance

Maintenance issues associated with Vegetated Natural Buffers are related to integrity of the VNB and damage to the natural or planted vegetation or the infiltration capabilities within the VNB. To determine if the VNB is properly functioning or whether it needs maintenance requires that an inspection be done during and soon after a storm. The inspection should determine if the VNB is providing sheet flow and infiltration of the required treatment volume within its permitted time frames, generally 24 to 72 hours after a storm. If this is not occurring, then the

cause of must be determined and appropriate actions undertaken beginning with those specified in the system's Operation and Maintenance Plan.

VNBs must be inspected annually by the operation and maintenance entity to determine if there has been any encroachment or violation of the terms and condition of the VNB as described below. Reports documenting the results of annual inspections shall be filed with the County every three years, or upon discovery of any encroachment or violation of design parameters, whichever occurs first.

A. Inspection Items:

- Inspect VNB for storage volume recovery within the permitted time, generally less than 72 hours. Failure to percolate the required treatment volumes indicates reduction of the infiltration rate and a need to restore system permeability.
- Inspect VNB to assure that inflow is via sheetflow, for areas of channelized flow through or around the buffer, and for areas with erosion or sediment accumulation indicating channelized flow or that stabilization of the adjacent contributing area is needed.
- Inspect VNB for damage by foot or vehicular traffic or encroachment by adjacent property owners.
- Inspect VNB for any signs of erosion or sedimentation.
- Inspect VNB for the health and density of vegetation, and for the occurrence of exotic or nuisance plant species.

B. Maintenance Activities As-Needed To Prolong Service:

- If needed, restore infiltration capability of the VNB to assure it meets permitted requirements.
- Repair any areas where channelized flow is occurring and restore sheetflow.
- Repair any areas with erosion and carefully remove accumulated sediments if needed to assure the health and functioning of the VNB
- Stabilize eroding parts of the adjacent contributing area as needed to prevent erosion and sedimentation.
- Repair any damage to the VNB by foot or vehicular traffic and remove any fences or other materials that have been placed in the VNB by adjacent property owners.
- Maintain the VNB vegetation and, if necessary, replant the VNB with approved Florida-friendly vegetation as needed to assure sheet flow and prevent erosion and sedimentation. Remove any exotic or nuisance species from the VNB.

All repairs to the VNB must be made as soon as practical in order to prevent additional damage to the buffer. Repaired areas must be re-established with approved Florida-friendly or native vegetation.

5.9. Pervious Pavement Systems

5.9.1. Description

Pervious pavement systems include the subsoil, the sub-base, and the pervious pavement (Figure 5.9.1). They can include several types of materials or designed systems such as pervious concrete, pervious aggregate/binder products, pervious paver systems, and modular paver systems. Pervious asphalt and pervious pavements using crushed and recycled glass will not be allowed unless product-specific information and verification testing results are provided to demonstrate sufficient structural capability and hydraulic performance. Recent studies on the design, longevity, and infiltration characteristics of pervious pavement systems are available on the University of Central Florida’s website <https://stormwater.ucf.edu>.

Pervious pavement systems are [retention systems](#). They should be used as part of a treatment train to reduce stormwater volume and pollutant load from parking lots, or similar types of areas. As with all infiltration BMPs, the treatment efficiency is based on the amount of the annual runoff volume infiltrated which depends on the available storage volume within the pavement system, the underlying soil permeability, and the ability of the system to readily recover this volume.

PERVIOUS PAVEMENT SUMMARY

Advantages/Benefits	Reduces site imperviousness, stormwater volume, peak discharge rate, pollutant loadings, temperature, and heat island effect. Provides ground water recharge. Increases development potential of site.
Disadvantages/Limitations	More expensive than traditional pavement and more difficult to install and maintain. Limited to low traffic areas with limited structural load. Possible ADA issues for handicapped. Do not construct within 75 feet of a public or private potable water supply well or within 15 feet of an onsite wastewater disposal and treatment system. Site must have appropriate soil and SHGWT conditions for infiltration. Not appropriate on sites with potential hazardous or toxic materials.
Volume Reduction Potential	Moderate to High depending on area with pervious pavement
Pollutant Removal Potential	Moderate to High for all pollutants removal is directly related to the annual percent of stormwater retained and not discharged
Key design considerations	Must use certified installer. Must use on areas with flat or minimal slope. Must incorporate perimeter edge restraint. Must use in-situ infiltration measurements. Must have minimum 2”/hr infiltration rate through the entire system. SHGWT at least 2 feet below bottom; recovery of treatment volume within 24 – 72 hours;
Key construction and maintenance considerations	Minimize soil compaction and sedimentation during construction; ensure design infiltration is met after construction; inspect during wet season to see if water is ponding and not infiltrating properly; use regular vacuum sweeping to minimize clogging and maintain infiltration capacity as needed to meet permit requirements; must maintain at least 2”/hr percolation rate; areas with high levels of wind-blown sediments (e.g., near the beach) may create maintenance issues.

FIGURE 5.9.1. Typical Pervious Pavement Cross Section

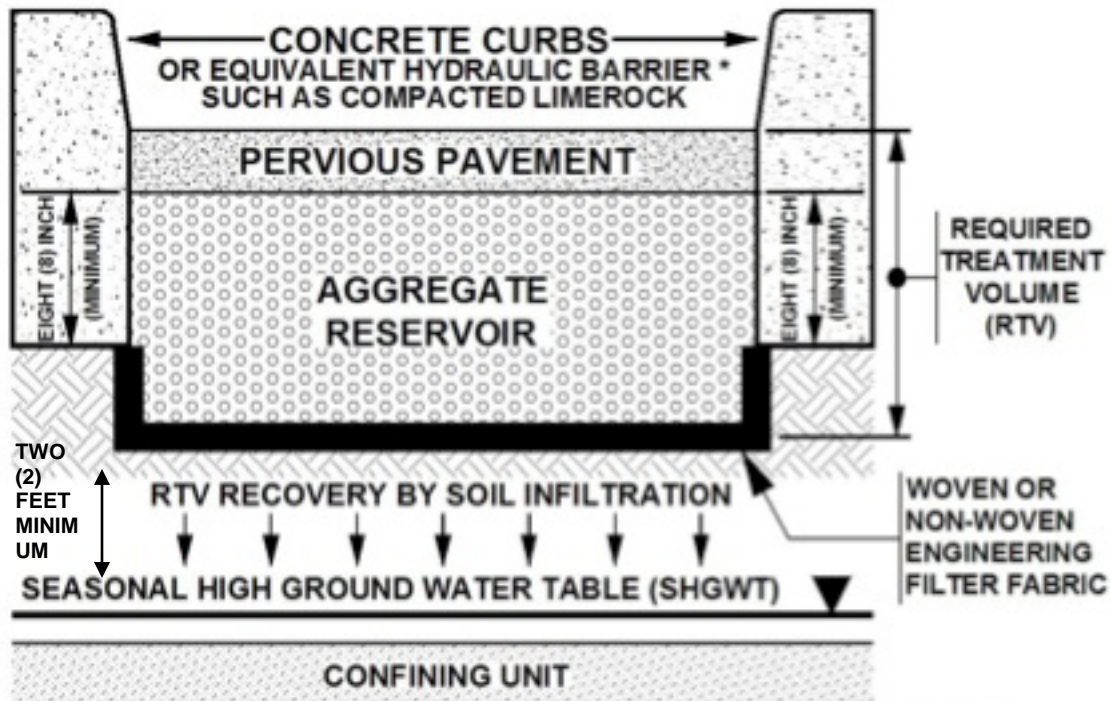

* THE PURPOSE OF THE PERIMETER CONCRETE CURBING (OR EQUIVALENT BARRIER) IS TWOFOLD. FIRST, CONCRETE CURBING (IF UTILIZED) CAN ALLOW NUISANCE PONDING ABOVE THE PERVIOUS PAVEMENT. SECOND, CONCRETE CURBING WILL REDUCE HORIZONTAL SCOUR EROSION SHOULD THE SYSTEM FAIL.

TYPICAL PERVIOUS PAVEMENT CROSS SECTION

NOT TO SCALE

5.9.2. Applicability

Pervious pavement systems can be used for many impervious applications (i.e. sidewalks, driveways, on-street parking) but they primarily are used in parking lots, especially the parking stalls. Typically, pervious pavements are used in areas with low-traffic volume, low truck traffic, and low number of turning areas. To address these concerns, pervious pavements often are integrated with traditional impervious pavements such as within a parking lot where the parking stalls are pervious pavements. The designer must consider the limitations of the pervious pavement system application in determining its proper application. In addition, the designer must consider various site conditions and potential challenges including:

1. Poorly draining soils such as those with shallow Seasonal High Ground Water Tables (SHGWTs), shallow confining units (i.e., clays/hardpans), organic mucks, etc.
2. In areas subject to high traffic volumes, regardless of wheel loads. It is recommended that:
 - The number of vehicles using a pervious pavement parking stall should not exceed one hundred (100) vehicles per day for most pervious pavement systems.
 - Traditional Class I concrete, brick pavers, or an appropriate asphalt section should be used in areas subject to high traffic volumes such as the primary driving areas within a parking lot.

- Regardless of wheel loads, pervious pavement should not be used on areas of frequent turning movements (public roadways, drive thru lanes, around gas pumps, adjacent to dumpster pads, driveway entrances, etc.). It is recommended that traditional Class I concrete, brick pavers or an appropriate asphalt section be used in these areas.
3. If pervious pavement is proposed for areas with heavy wheel loads or other non-recommended conditions, then the applicant shall be required to use alternate methods of pavement design. This may include using imported (hydraulically clean) soils, structural/permeable geo-fabrics, thicker pervious pavement sections, etc. above the parent soil. Hydraulically clean soils will be defined as those that are free of materials (clays, organics, etc.) that will impede the soil's saturated vertical and horizontal hydraulic conductivity.
 4. Pervious pavements shall not be used in areas with high potential for hazardous material spills that could seep into the underlying ground water. Examples of these areas include (but are not limited to) auto maintenance facilities, auto parts stores that are subject to on-site installation of hazardous materials by customers or store personnel, chemical plants, etc.
 5. Certain pervious pavement systems may create the potential for tripping hazards that needs to be considered when designing areas used by pedestrians or the handicapped.
 6. Any underground treatment systems should not be located directly under pervious pavement.

5.9.3. Required Treatment Volume

The Required Treatment Volume (RTV) necessary to achieve the desired treatment efficiency shall be routed to the pervious pavement system and percolated into the ground. Refer to [Section 5.3.2](#) for the requirements that apply to all retention BMPs.

5.9.4. Calculating Load Reduction Efficiency for a Given Retention Volume

Use [Table A1-1](#) to determine the treatment volume needed to achieve an 80% pollutant load reduction if pervious pavement systems are being used to fully achieve the required level of pollutant load reduction.

If pervious pavement systems are being used as part of a BMP treatment train to achieve some level of pollutant load reduction but not the total amount of the required nutrient load reduction, use [Table A2-1](#).

5.9.5. Design Criteria

Pervious pavement system design has two major components: structural and hydraulic. The pervious pavement system must be able to support the traffic loading while also (and equally important) functioning properly hydraulically. This section does NOT discuss structural designs of pervious pavement systems. Stormwater permit applicants (and their engineering consultants) should consult the product manufacturer's pavement design standards to ensure that pervious pavements will be structurally stable, and not be subject to premature deterioration failure.

Below are the types of practices, specifications, recommendations, tools and potential conditions for applicants to consider for the approval of pervious pavement systems. This is not intended to cover all potential designs. Professional judgment must be used in the design and review of proposed pervious pavement systems.

1. Pervious pavement systems must have the capacity to retain the required treatment volume without a discharge and without considering soil storage.

2. The applicant must provide reasonable assurances that **a contractor, trained and certified by the product manufacturer, will install** the proposed pervious pavement system. To meet this requirement, the applicant must supply documentation of the appropriate contractor certification as part of the site plan process. If the pervious pavement contractor is not known at the time of site plan submittal, a special condition shall be placed in the site plan approval to require submittal of the contractor's certification prior to construction commencement.
3. The seasonal high ground water table shall be at least two feet beneath the bottom of the pervious pavement system unless the applicant demonstrates, based on plans, test results, calculations or other information, that an alternative design is appropriate for the specific site conditions. The "system" is defined as the pervious pavement itself, the underlying storage reservoir, if used (i.e., pea rock, #57 stone, etc.), and the geo-fabric that wraps the underlying storage reservoir (refer to Figures [5.9.1](#) through [5.9.4](#) for additional information).
4. The pervious pavement system must provide the capacity for the recovery of the required treatment volume of stormwater within 72 hours, with a safety factor of two, assuming average Antecedent Runoff Condition (ARC 2). In a pervious pavement system, the stormwater is drawn down by natural soil infiltration and dissipation into the ground water table, as opposed to underdrain systems which rely on artificial methods like perforated or slotted drainage pipes. A drawdown or recovery analysis is required that accounts for the mounding of ground water beneath the pervious pavement system. Details related to safety factors, recovery/mounding analysis and supporting soil testing is provided in [Appendix B](#) of this Manual.
5. The minimum vertical hydraulic conductivity of the pervious pavement system shall not be less than 2.0 inches per hour. The percolation rate of the subgrade soils can be as low as 0.5 inch/hour when the pervious pavement system includes a reservoir of at least 6 inches of rock below the pavement.
6. Pervious pavement systems shall not be constructed within 75 feet of a public or private potable water supply well or within 15 feet of an onsite wastewater disposal and treatment system.
7. The in-situ (or imported) subgrade soil (below the pervious pavement system) shall be compacted to a maximum of 92% - 95% Modified Proctor density (ASTM D-1557) to a minimum depth of 24 inches. For proposed pervious pavements within redevelopment projects, the existing pavement section and its compacted base shall be removed. The underlying soils are to be scarified to a minimum 16 inch depth, re-graded, filled with hydraulically clean soils (if applicable) and proof rolled to a maximum compaction of 92% - 95% Modified Proctor density (ASTM D-1557).
8. Other than pedestrian walks, bicycle paths and driveway ingress or egress areas, the maximum slope for pervious pavements is 1/8 inch per foot (1.04%) although zero % slope is preferred. The primary issue of concern is the hydraulic ability of the pervious pavement system to percolate the Required Treatment Volume (RTV) into the underlying sub-soil.
9. Except for pervious walks and bike paths, curbing, edge constraint or other equivalent hydraulic barrier will be required around the pervious pavement to a minimum depth of eight (8) inches beneath the bottom of the pavement and to the depth necessary to prevent scouring from the horizontal movement of water below the pavement surface depending on the adjacent slopes. Refer to [Figures 5.9.1](#) through [5.9.4](#) for additional information. Another option is to create check dams within the aggregate reservoir that will reduce runoff velocity and the potential for scour.

The horizontal movement of water can cause scour failure at the edge of the pervious pavement system, or mask the hydraulic failure of the system due to plugging of the deeper voids in the pervious pavement or aggregate reservoir. The cross sectional construction

drawings of the pervious pavement system and its relationship to the slopes of adjacent areas must include a demonstration that the depth of the curbing, edge constraint or other equivalent hydraulic barrier is sufficient to prevent erosion and scour. As an option, the delineated areas of nuisance ponding can be shown on the supporting stormwater application sketches or drawings.

To minimize scour, the velocity of flow at the flood control design condition shall be between 2 and 5 feet per second.

10. To provide an indicator that the pervious pavement system has failed or needs maintenance, the system shall be designed to allow a minimum ponding depth of one (1) inch and a maximum ponding depth of two (2) inches prior to down-gradient discharge with the exception of pervious walks and bicycle paths (see Figures 5.9.1 through 5.9.4). The permitted construction plans shall delineate the areas of pervious pavement that may be subject to nuisance ponding. As an option, the delineated areas of nuisance ponding can be shown on the supporting ERP application sketches or drawings.
11. The pervious pavement system must be designed to have an overflow at the nuisance ponding elevation to the down-gradient stormwater treatment or attenuation system or outfall (see Figures [5.9.2](#) through [5.9.4](#)).
12. Erosion and sediment controls on adjacent landscaped areas must be kept in place until all of the contributing area is stabilized. Runoff from adjacent landscaped areas must NOT be directed onto pervious pavement system areas unless the Applicant demonstrates that the offsite areas that drain onto the pervious pavement will not increase sediment, silt, sand, or organic debris that increases the potential for clogging the pervious pavement. The design must minimize the likelihood of silts and sands from plugging the pavement void spaces (see [Figures 5.9.7](#) through [5.9.9](#)).
13. With the exception of non-vehicular pervious pavements (e.g. pervious walks, bicycle paths, courtyards, plazas, patios), the installation of Embedded Ring Infiltrometer Kit (ERIK) is required (see Figures [5.9.5](#) and [5.9.6](#)). A minimum one (1) ERIK in-situ infiltrometer will be required for each section of pervious pavement installed. For larger sections, a minimum of two (2) in-situ ERIK infiltrometers per acre of pervious pavement are required. ERIK Infiltrometers shall be placed in the lowest part of the pervious parking area where ponding will occur if the pavement fails to infiltrate properly. The location of the ERIK infiltrometers shall be shown on the construction plans or other supporting sketches or drawings for the project.
14. Documentation of ERIK infiltrometer construction, and post-construction testing, shall be required with submittal of the construction completion certification. Test results shall be provided in report form, certified by the appropriate Florida Registered Professional. The construction completion certification shall not be accepted if the vertical hydraulic conductivity is less than 2.0 inches per hour or is less than the permitted design percolation rate in any of the required ERIK infiltrometers, as appropriate.
15. For proper maintenance of most pervious pavement systems, periodic vacuum sweeping is recommended. At a minimum, vacuum sweeping is required annually but frequency depends on traffic volume and runoff contributions from adjacent landscaping. If ERIK tests indicate a vertical hydraulic conductivity rate less than 2.0 inches per hour, or is less than the permitted design percolation rate, or when nuisance ponding occurs, vacuum sweeping is required. Vacuum sweeping is required for areas that are subject to wind transported soils (near sand dunes or other coastal areas) or other conditions where excessive soil or other debris deposition is expected to occur (from adjacent landscaping mulch and leaf litter, from areas with high leaf fall, fugitive sands and lime rock fines from adjacent construction sites).

16. A remediation plan shall be submitted to the County for implementation by the permittee should vacuum sweeping fail to improve the vertical hydraulic conductivity to a rate greater than 2.0 inches per hour, or equal to or greater than the permitted design percolation rate, or resolve the nuisance ponding. The remediation plan shall be prepared and submitted to the County for review and approval. Maintenance records shall be retained by the permittee and made available to the County as part of the required O&M re-inspections and certifications.
17. Entrances to pervious pavement areas shall be posted by signs to inform users they are entering a pervious pavement area and that any vehicles with heavy wheel loads or with muddy tires should not enter.
18. Water quality credit for non-vehicular pervious pavements:
This section applies only to pervious pavement walks, bicycle paths, courtyards, plazas, and patio areas. To encourage the use of pervious pavement, the following credits are established these non-vehicular pervious pavements:
 - For soils with SHGWT depths of 0" to 18" below the bottom of the pervious pavement system, 80% of the non-vehicular pervious pavement areas can be subtracted from the total contributing area when computing the project's required treatment volume.
 - For soils with SHGWT depths greater than 18" below the bottom of the pervious pavement system, 100% of the non-vehicular pervious pavement areas can be subtracted from the total contributing area when computing the project's required treatment volume.

To receive this credit, non-vehicular pervious pavements must be placed over native upland soils (excluding wetlands), appropriate clean fill, or soil media described in [Section 5.15](#). For redevelopment projects, they must be placed over rehabilitated soils as described in 7 above.

For non-vehicular pervious pavements that are properly designed, constructed, and maintained pursuant to this Section of the manual, vacuum sweeping, remediation plans and ongoing O&M re-inspections and certifications will not (normally) be required.

5.9.6. Required Site Information

Successful design of a pervious pavement system depends heavily upon conditions at the site, especially information about the soil, geology, and water table conditions. Specific data and analyses required for the design of a pervious pavement system are set forth in [Appendix B](#).

5.9.7. Construction requirements

The following construction procedures are required to assure that the pervious pavement is properly prepared and installed such that the desired infiltration rate is obtained:

1. The location and dimensions of the pervious pavement shall be verified onsite prior to its construction. All design requirements including pervious pavement dimensions and distances to foundations, septic systems, and wells need to be verified.
2. The location of pervious pavement areas shall be clearly marked at the site to prevent unnecessary vehicular traffic across the area causing soil compaction.
3. Excavation shall be done by lightweight equipment to minimize soil compaction. Tracked, cleated equipment does less soil compaction than equipment with tires.
4. Once the subgrade elevation has been reached, the area shall be inspected for materials that could puncture or tear the filter fabric, such as tree roots, and assure they are not present.
5. The in-situ (or imported) subgrade soil (below the pervious pavement system) shall be compacted to a maximum of 92% - 95% Modified Proctor density (ASTM D-1557) to a minimum depth of 24 inches.

6. The specified filter fabric shall be installed in accordance with the design specifications.
7. The aggregate material shall be inspected prior to placement to ensure it meets size specifications and is washed to minimize fines and debris. It should be spread uniformly to the appropriate thickness.
8. The pervious pavement material shall be installed by a contractor, trained and certified by the product manufacturer, to install the proposed pervious pavement system according to approved design specifications. When pervious pavements are being used, the mix shall be tested to assure it meets specifications before it is accepted and poured.
9. Stormwater shall not be directed onto the pervious pavement from adjacent contributing areas until after they are stabilized to prevent sediment from entering and clogging the pervious pavement.
10. Before the pervious pavement is placed into operation, signs shall be installed at all entrances advising users that they are entering a pervious pavement parking lot and that vehicles with heavy wheel loads or muddy tires should not enter.
11. An applicant may propose alternative construction procedures to assure that the design infiltration rate of the pervious pavements is met.

5.9.8. Inspection, Operation and Maintenance

Maintenance issues associated with pervious pavements are related to clogging of the porous surfaces which reduces or prevents infiltration thereby slowing recovery of the stormwater treatment volume and often resulting in standing water and the designed nuisance flooding.

To determine if the pervious pavement is properly functioning or whether it needs maintenance requires that either an inspection be within 72 hours of a storm and that the ERIK devices be used to test the infiltration rate as specified below.

A. Inspection Items:

- Inspect pervious pavement for storage volume recovery within the permitted time, generally less than 72 hours. Determine if nuisance flooding is occurring in those areas of the parking lot that were designed to flood if the pervious pavement was failing. Nuisance flooding indicates that the required treatment volume is not infiltrating because of a reduction of the infiltration rate and a need to restore system permeability
- Use the ERIK infiltrometers at least once every two (2) years to test if the vertical hydraulic conductivity is less than 2.0 inches per hour or is less than the permitted design percolation rate in any of the required ERIK infiltrometers. If any of the ERIK infiltrometers have rates less than the permitted rate, maintenance activities shall be undertaken to restore the permeability of the pervious pavement. The results of the ERIK infiltrometer testing shall be submitted to the County.
- Inspect all edge constraints and overflow areas to determine if any erosion is occurring and repair as needed.

B. Maintenance Activities As-Needed To Prolong Service:

- Vacuum sweeping will be conducted annually and whenever the vertical hydraulic conductivity is less than 2.0 inches per hour or is less than the permitted design percolation rate in any of the required ERIK infiltrometers. Vacuum sweeping will be done on an as-needed basis on pervious pavements located in areas that are subject to wind transported soils (near sand dunes or other coastal areas) or other conditions where excessive soil or other debris deposition is expected to occur (from adjacent landscaping mulch and leaf litter, from areas with high leaf fall, fugitive sands and lime rock fines from adjacent construction sites, etc.).
- A remediation plan shall be submitted to the County should vacuum sweeping fail to improve the vertical hydraulic conductivity to a rate greater than 2.0 inches per hour, or equal to or greater than the permitted design percolation rate, or resolve the nuisance

ponding. The remediation plan shall be prepared and submitted to the County for review and approval.

- Repair erosion near edge constraints or overflows and assure that the contributing drainage area is stabilized and not a source of sediments.

Figure 5.9.2. Pervious Pavement System Cross Section #1

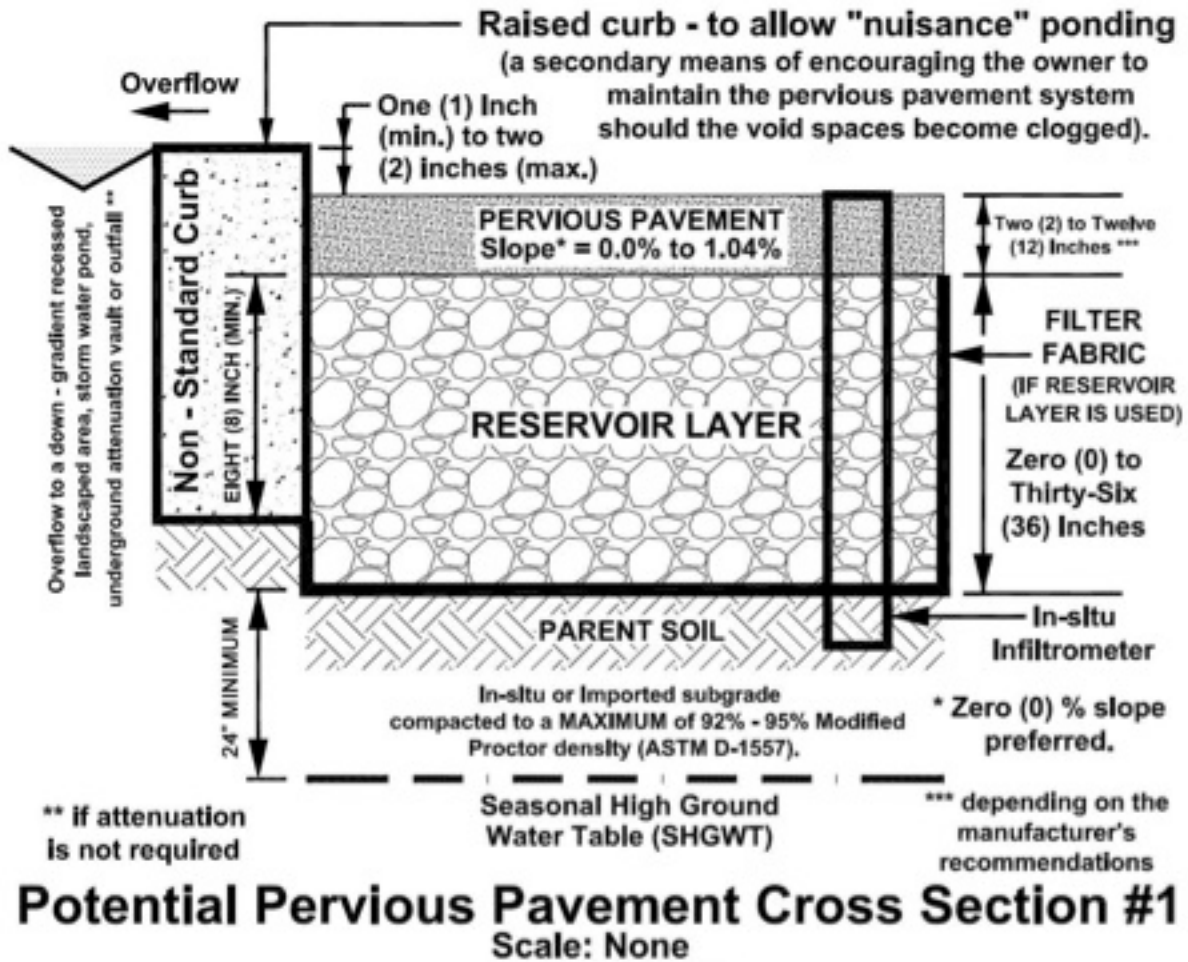

Figure 5.9.3. Pervious Pavement System Cross Section #2

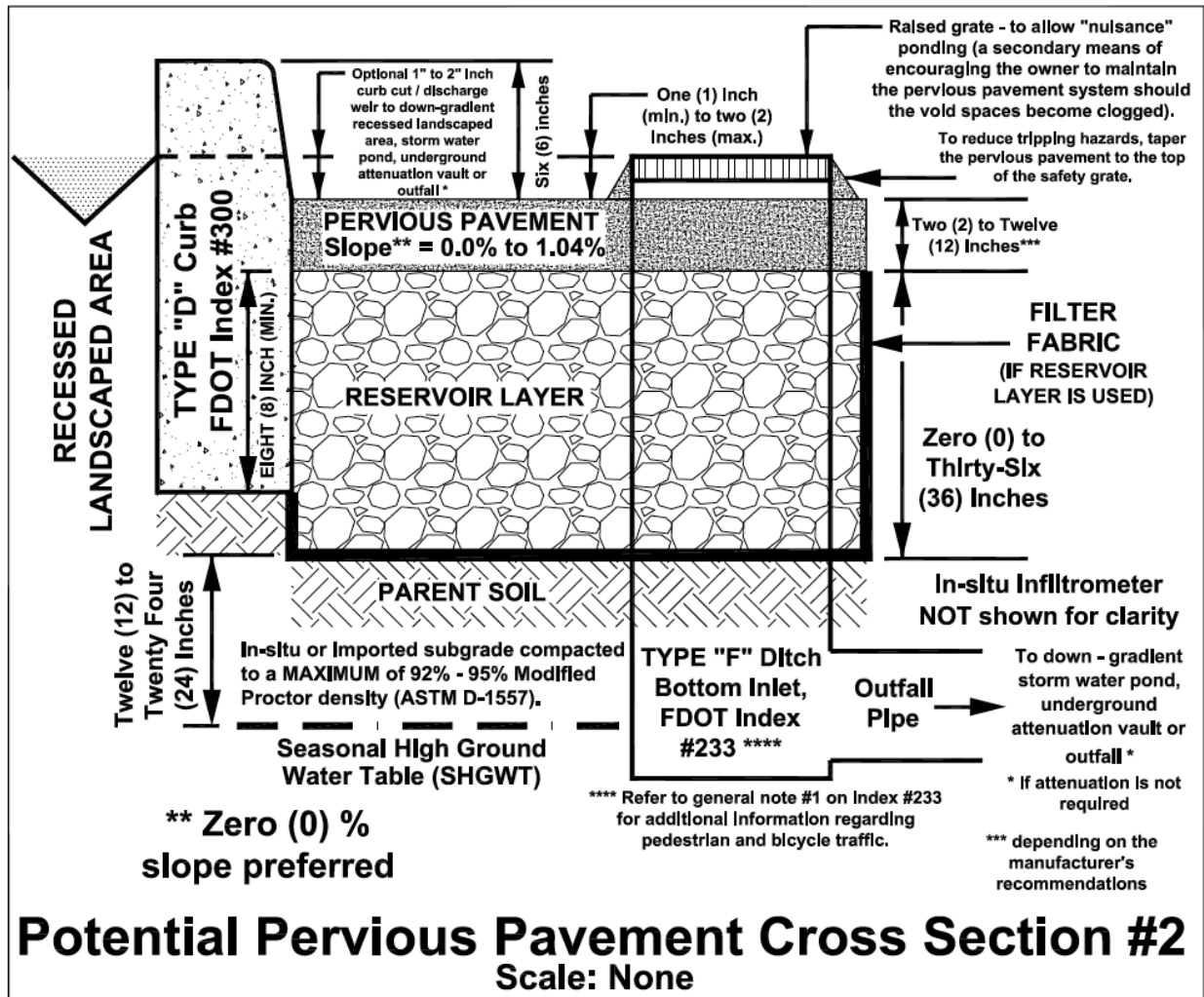

Figure 5.9.4. Typical Pervious Pavement System Cross Section #3

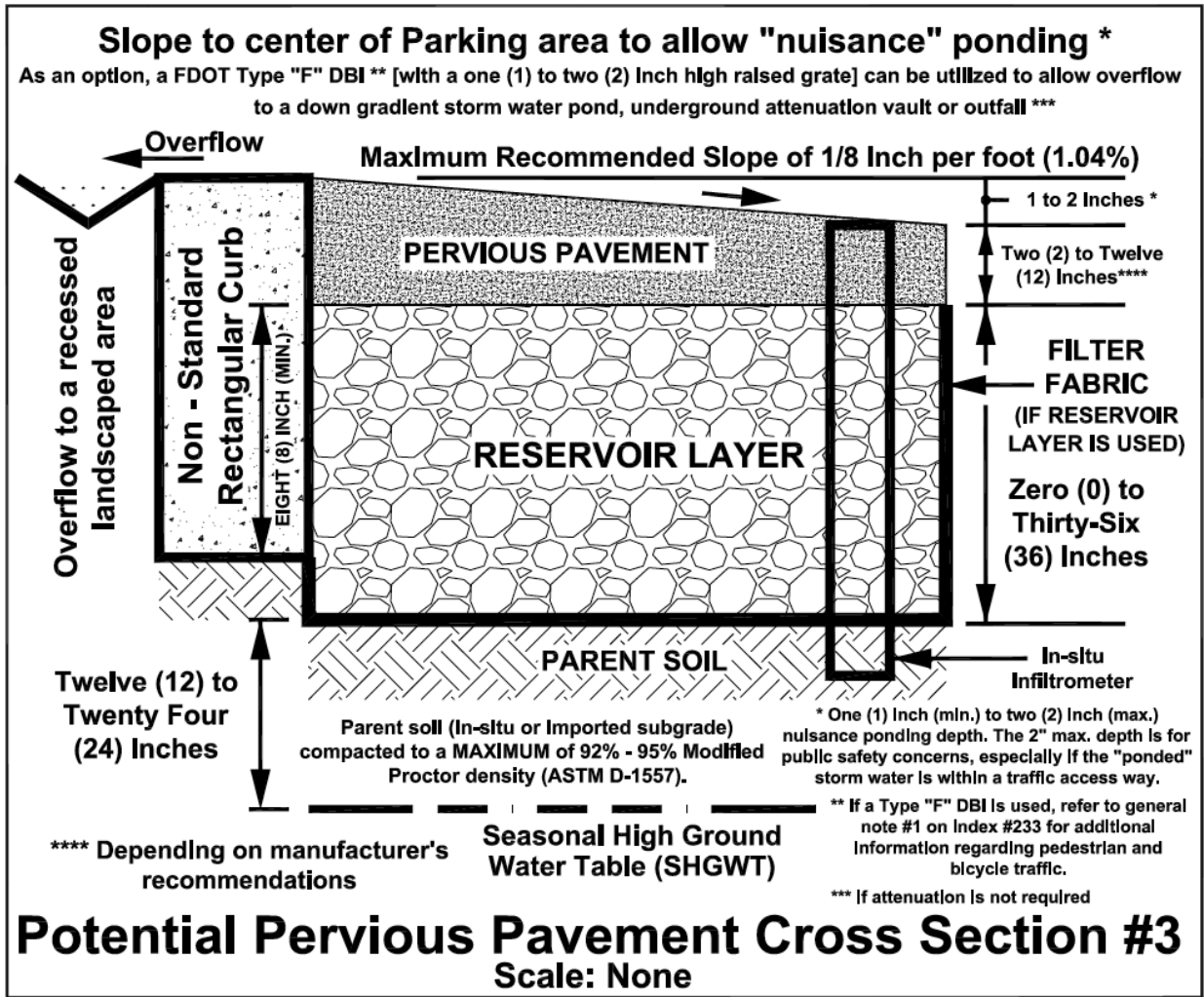

Figure 5.9.5. Plan View of ERIK In-Situ Infiltrometer - (Embedded Ring Infiltration Kit)

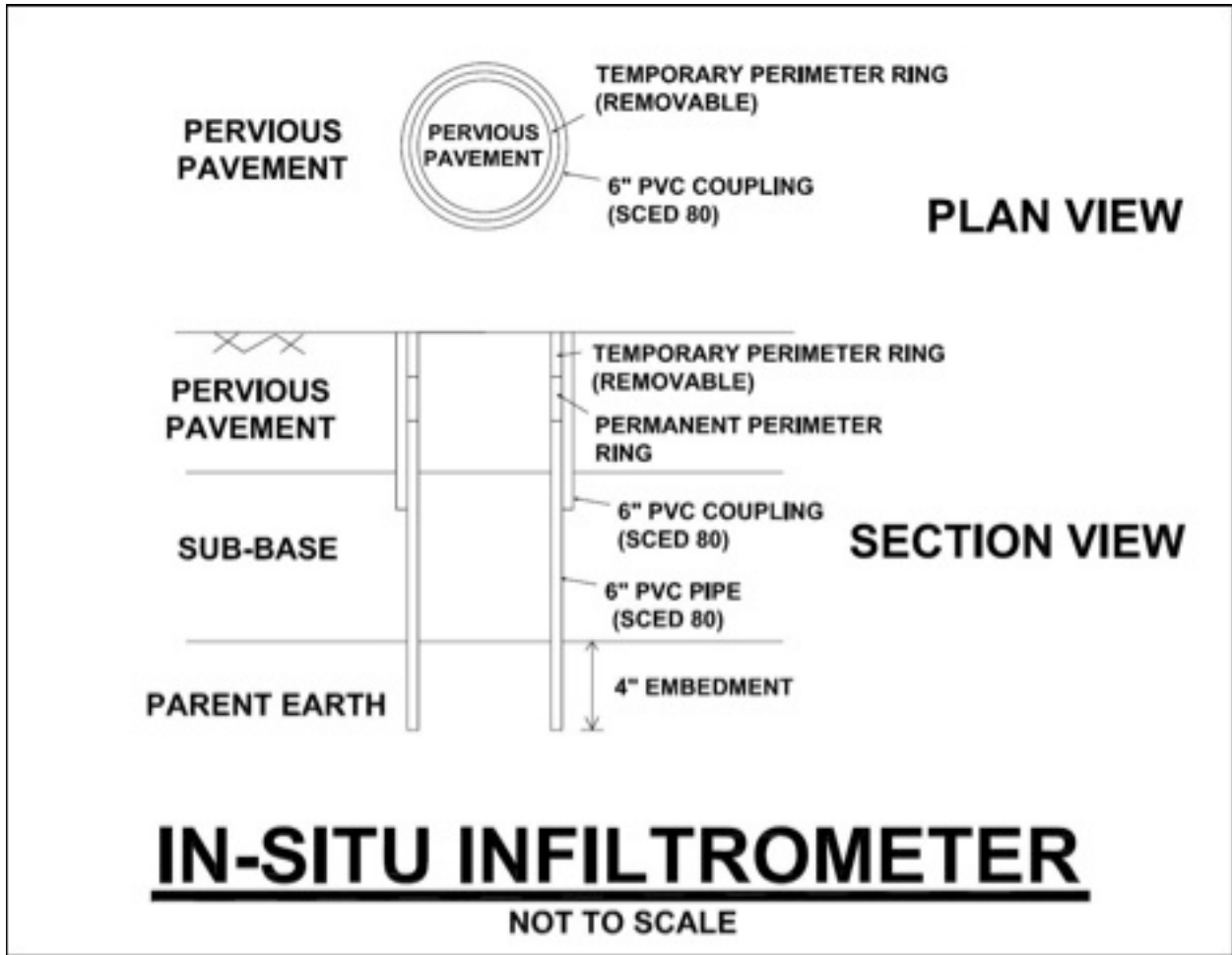

Figure 5.9.6. ERIK Measuring Tube

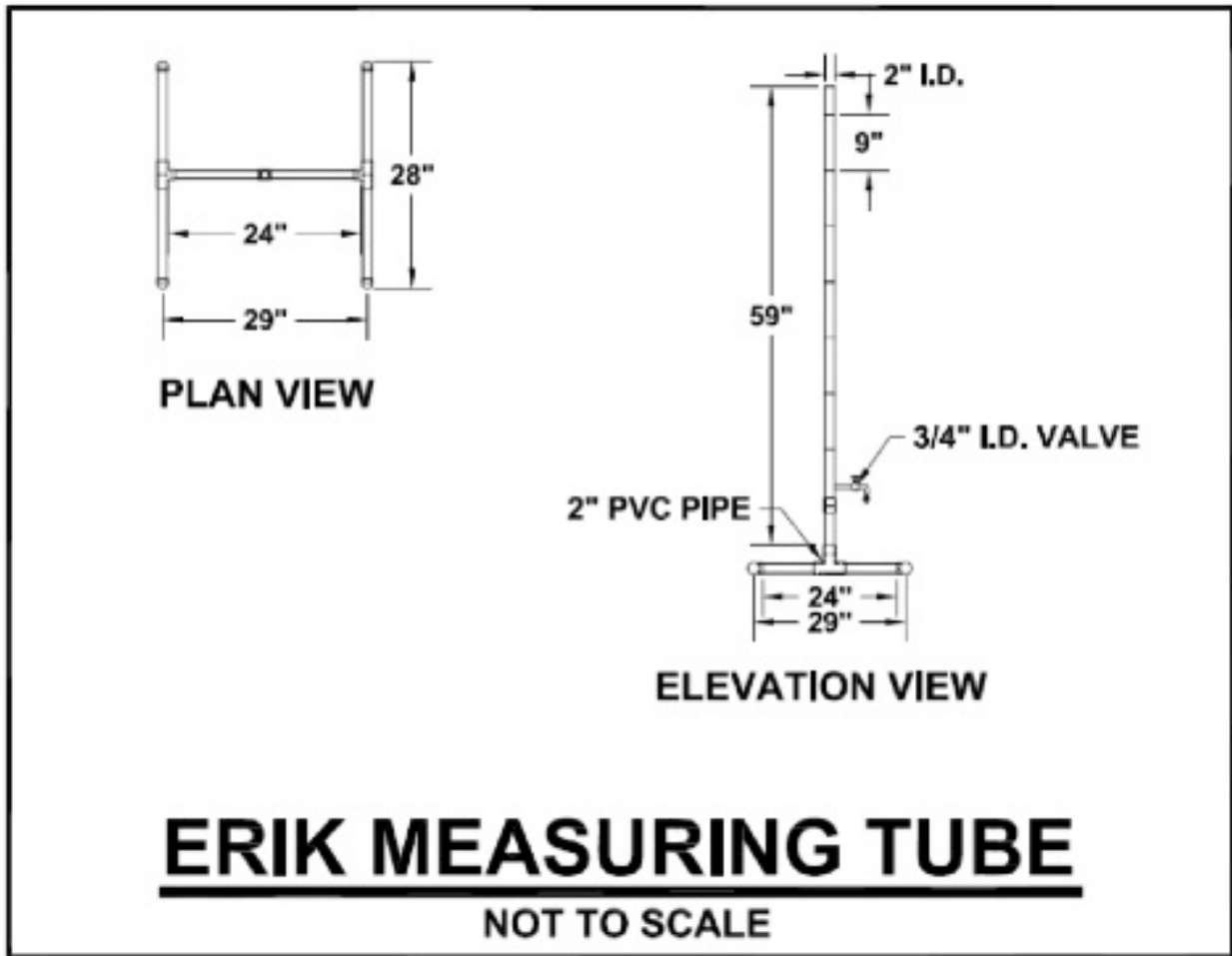
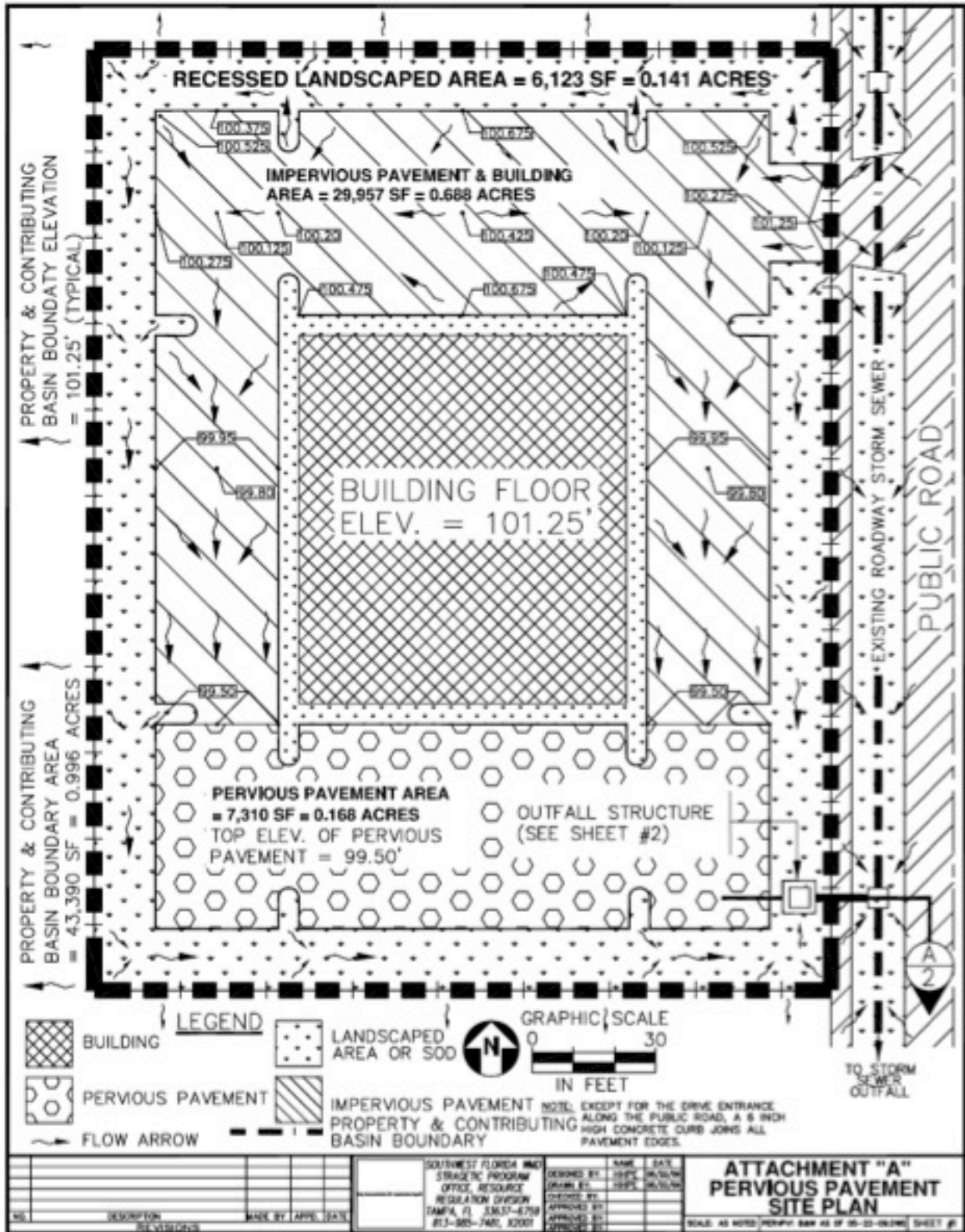

Figure 5.9.7. Pervious Pavement Site Plan



5.9.10. Pervious Pavement Examples in Escambia County

During the development of the Manual, the authors visited LID BMP sites within Escambia County to obtain pictures and inspect the BMPs. This section includes photos of pervious pavement sites and a summary of the Juanita Williams Park pervious pavement project including lessons learned.

Juanita Williams Park

This 2-acre neighborhood park on Bayou Chico consists of a covered pavilion, playground, 1/4 mile walk path, security lights, benches, grills, picnic area and small indoor facility suitable for a community gathering spot. It located at 505 Edgewater Drive within an older residential subdivision.

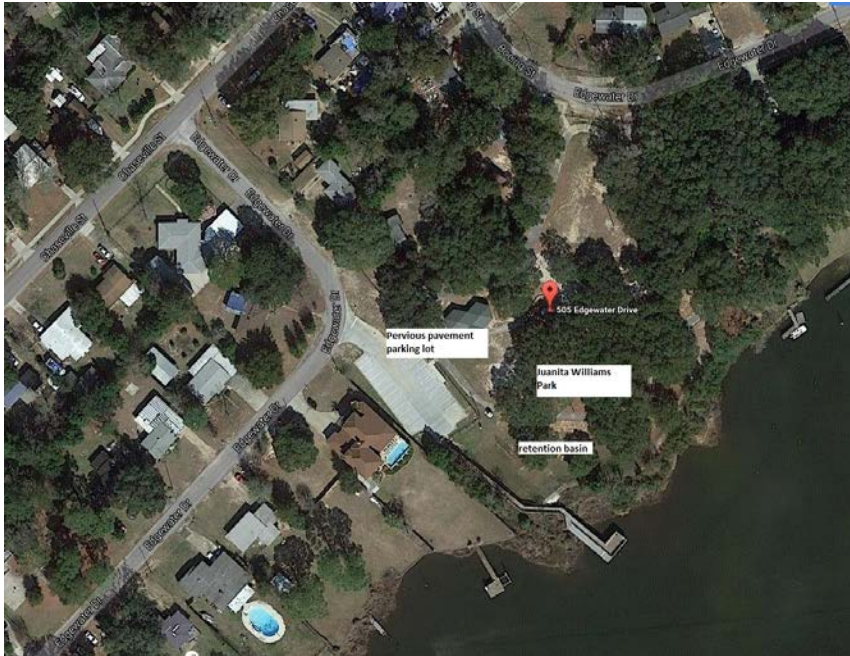

The project was undertaken to remove and replace an existing 8,770-sf gravel/dirt parking lot. Since Bayou Chico is an impaired water body, the County needed to ensure that the post-development nutrient loading was less than the pre-development nutrient loading. Additionally, the County wanted to demonstrate the use of pervious pavement as an LID BMP

The site improvements included constructing a full depth pervious concrete pavement section within the

limits of the existing curb and gutter, re-striping the new parking lot surface with thermoplastic paint, construction of a concrete sidewalk, construction of curb and gutter, and installation of traffic control signs.

The project construction included:

- removal of the existing gravel/dirt surface within the limits of the existing curb and gutter to a minimum depth of 12-inches below existing grade.
- removal of unsuitable materials to a depth greater than 12-inches below existing grade where needed to achieve the design requirements of the parking lot sub-grade.
- removal of 35-lf of existing curb and gutter and 50-sy of miscellaneous concrete area.
- Installation of curb and gutter.
- Installation of gravel sub-base
- compaction of subgrade to meet plan specifications.
- installation of pervious pavement.
- curing of pervious pavement.
- striping of parking lot with thermoplastic paint.
- Installation of signage.
- Installation of sidewalk.

Lessons learned from the project: The primary lesson is to do a better job of determining how much stormwater volume will flow onto the pervious parking lot from Edgewater Drive and planning it. In particular, the stormwater from Edgewater Drive needs to be better distributed across the entire pervious parking lot instead of flowing down the center line. This can be accomplished by putting in a low V-shaped diversion similar to the speed bars used before stop signs. Additionally, an ERIK device should have been installed near the overflow to the retention basin to allow easy measurement of the infiltration rate.

Project photos:

Pre-development Parking lot



Excavating site



Curb installed fill underway



Under soil installed



Filter fabric gravel subbase



Subbase complete



Pervious concrete pour begins



Rolling the concrete



Pour, roll, and cure concrete

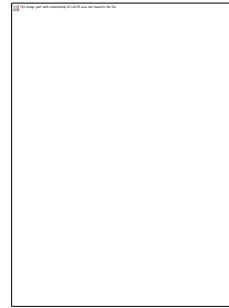

Curing the pervious concrete

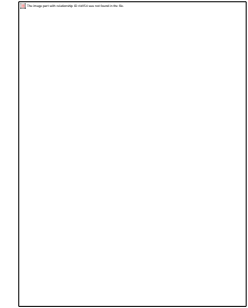

Pervious parking lot complete



Connection to Edgewater Drive



July 2016

Completed parking lot, stormwater running onto pervious parking lot from Edgewater Dr.



Other pervious concrete examples in Escambia County

Pervious pavers on Perdido Key



Turf blocks at Perdido Visitor Center



Turf block at Global Learning Center



Grass parking at local church



5.10. Greenroof with Cistern Systems

5.10.1. Description

A greenroof with cistern stormwater treatment system is a vegetated roof followed by storage in a cistern (or other similar device) for the filtrate that is reused for irrigation. [Section 5.10.4](#) describes the two classes of greenroofs: intensive and extensive. A greenroof and cistern system is a LID retention and harvesting BMP. Its effectiveness is directly related to the annual volume of roof runoff that is captured, retained, and reused. The filtrate from the greenroof is

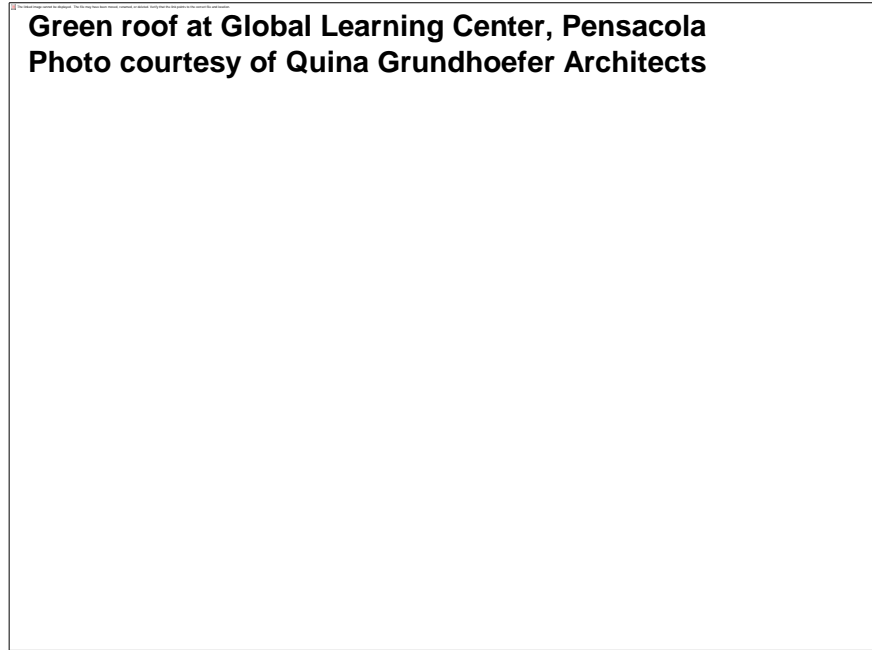

collected in a cistern or, if the greenroof is part of a BMP Treatment Train, the filtrate may be discharged to a downstream BMP such as a wet detention pond. A cistern is sized for a specific amount of filtrate and receives no other stormwater. Other pond storage must also provide capacity to detain a specified quantity of filtrate.

The retained water is used to irrigate the roof since experience in Florida has shown that irrigation must be provided to maintain the plants. A back up source of water for irrigation is

necessary during the dry season. Excess filtrate and excess runoff can be discharged into other stormwater treatment systems, infiltrated into the ground, or used for irrigation or other non-potable purposes.

The greenroof and cistern system functions to attenuate, evaporate, and lower the volume of discharge and pollutant load coming from the roof surface. Greenroof systems have been shown to assist in stormwater management by attenuating hydrographs, neutralizing acid rain, reducing volume of discharge, and reducing the annual mass of pollutants discharged. They are most applicable to commercial or public buildings, but have been successfully used on residences.

Concentrations of pollutants discharged from a greenroof with pollution control media have been shown to be approximately the same as would be anticipated from a conventional roof. Thus, the concentration and mass must be managed. If no pollution control media are used, greenroof concentrations are greater than those from conventional roofs. In addition, with fertilization of the plants, increased nutrients are expected and storage for the filtrate is required.

GREENROOF/CISTERN SUMMARY

Advantages/Benefits	Reduces site imperviousness, stormwater volume, peak discharge rate, pollutant loadings, temperature, and heat island effect. Increases insulation of roof reducing energy use for heating and cooling. A six inch extensive roof provides insulation equivalent to about R-7 with energy cost savings of 10-15%. Increases
---------------------	---

	efficiency of solar cells. Increases life of roof to over 50 years. Can be an aesthetic amenity or an area for gardening. Provides ground water recharge and water reuse. Increases development potential of site.
Disadvantages/Limitations	More expensive than traditional roofs and more difficult to install. Typically used on flat roofs. Must meet roof structural integrity and have handicap access if public access is allowed.
Volume Reduction Potential	Moderate to High depending on roof area and storage volume
Pollutant Removal Potential	Moderate to High for all pollutants depending on annual average retention volume and whether BAM is used in the media.
Key design considerations	Must be located on building roof. Treatment system includes waterproofing layer, root barrier layer, drainage layer, pollution control layer, filter fabric, growth media layer and vegetation with irrigation and storage for greenroof filtrate. Must have source of backup water supply. Must have minimum 2"/hr infiltration rate through the entire system. recovery of treatment volume within 24 – 72 hours;
Key construction and maintenance considerations	Ensure waterproofing components are installed properly by doing a water leak test. Install drainage layer, pollution control media, and growth media. Install and test irrigation system. Install and water plants until established. Weed and trim plants as needed.

5.10.2. Required Treatment Volume

Like all retention BMPs, the nutrient removal effectiveness is directly related to the annual volume of roof runoff that is retained and for greenroofs that is the volume stored within the greenroof and cistern system. However, since supplemental water inputs are needed for irrigation, some of which returns to the cistern, the cistern must be sized larger than the retention treatment volume. Nevertheless, the method can be used for nutrient load reduction.

The Required Treatment Volume (RTV) necessary to achieve the desired treatment efficiency will be captured by the greenroof and cistern system, then used for irrigation of the greenroof plants or other landscaping. Refer to [Section 5.3.2](#) for the requirements that apply to retention BMPs. Alternatively, use the graphs in [Section 5.10.9](#) to determine retention volumes and treatment effectiveness.

For those projects that will ultimately discharge to Verified [Impaired Waters](#) or water bodies with an adopted [TMDL](#), use [Tables A2-1](#) to determine the treatment volumes to achieve a variety of load reduction efficiencies based on the percentage of directly connected impervious area (DCIA) and the weighted curve number for non-DCIA areas.

5.10.3. Calculating Load Reduction Efficiency for a Given Retention Volume

Use [Table A1-1](#) to determine the treatment volume needed to achieve an 80% pollutant load reduction if pervious pavement systems are being used to fully achieve the required level of pollutant load reduction.

If pervious pavement systems are being used as part of a BMP treatment train to achieve some level of pollutant load reduction but not the total amount of the required nutrient load reduction, use [Table A2-1](#).

As an alternative, the design curves in [Section 5.10.9](#) can be used to determine the treatment volume.

5.10.4. Classification of Greenroof Surfaces

There are two types of greenroofs described in this Manual. An extensive greenroof is one where the root zone (pollution control layer and growth media layer) is less than 6 inches in depth. Intensive greenroofs have root zones greater than or equal to 6 inches and are typically intended for public or private access. There are two distinct functions for greenroofs, one is passive and the other is active. Passive greenroofs are intended only for maintenance access and typically require less maintenance, while an active roof is used for public and private access

Figure 5.10.1a. Extensive Greenroof Section (Usually Passive Function)

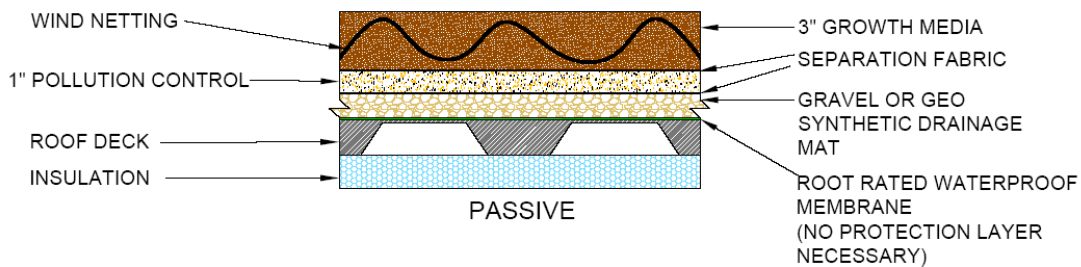

The root zone is comprised of the growth media and the pollution control media. A permeable fabric is used on both sides of the pollution control media to separate it from the soil or growth media layer above and a drainage layer below. A membrane, impervious to water and plant roots, is placed under the drainage layer to isolate the green roof system from the structural members of the building.

Greenroofs can be built on any type of roof deck with a minimum slope of one inch per foot if there is adequate structural support provided. Extensive roofs weigh approximately 10 – 35 lbs./ft² when wet while intensive roofs weigh approximately 45-100 lbs./ft² when wet. Accordingly, as part of the application, a structural engineer must certify that the roof can safely handle the weight load of the greenroof. There are several components that are required for greenroofs as described in the following sections of this Manual. Figures 5.10.1a and 5.10.1b provide typical greenroof details for the different types of roofs and various component details.

Figure 5.10.1b. Intensive Greenroof Section (Usually Active Function)

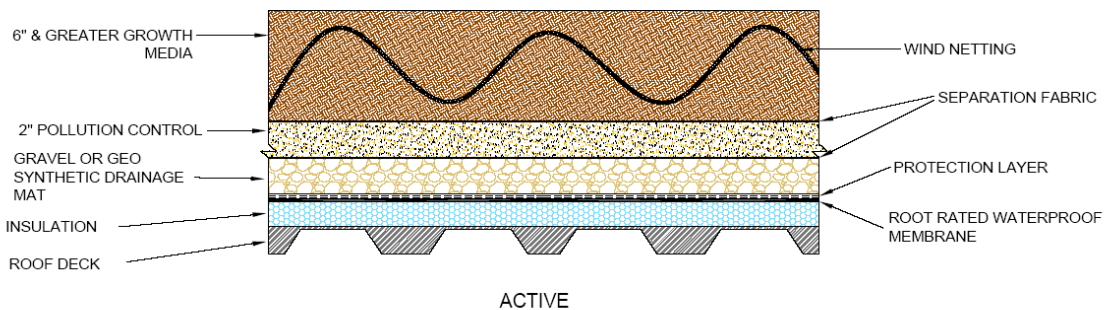

5.10.5. Design Criteria

1. **Minimum Retention** - Greenroof with cistern systems shall be designed to capture and use the required treatment volume for irrigation without discharge except into downstream BMPs if used as part of a BMP treatment train.
2. **Structural Integrity** – A structural engineer must certify that the roof can support the weight load of the greenroof system. Design must comply with [the American National Standards Institute \(ANSI\) VF-1, Fire Design Standard for Vegetative Roofs](#).
3. **Waterproof Membrane** - A waterproof membrane layer must be incorporated into the roof system to protect the structure from moisture damage. There are several options for this layer such as, polypropylene or polyethylene membrane, polyvinyl chloride, or spray applied elastomeric waterproofing membrane as well as others. The applicant must check with the membrane manufacturer to ensure that the membrane is rated as a **root protection material**. All permitted design specifications and manufacturer’s installation directions shall be followed to ensure that the proposed product will function as intended with greenroof overburden.
4. **Drainage Layer** - The major function of the drainage layer is to facilitate lateral movement of the filtrate to the point of drainage to ensure no standing water is present. The drainage layer can consist of several different materials such as gravel, recycled products, or geo-synthetic drainage mats. It is important to note that whatever material used shall not depress or elevate the pH of the filtrate more than 1.5 pH units from neutral (5.5 to 8.5). When using aggregate as drainage layer materials, it must contain no more than 7% “fines” (particles passing sieve number 200) by mass. The drainage material must be able to structurally support the intended greenroof overburden, as well as maintenance activities, without deflection such that drainage is blocked or restricted. A non-woven geotextile separation fabric must be installed on top of the drainage layer to prevent clogging of the drainage layer. This fabric shall have a thickness to pass the drainage water and void spaces such that the pollution control media does not fill the surface void area of the drainage layer and cause clogging. The hydraulic conductivity of the fabric must exceed 1.5 inches per hour.
5. **Pollution Control Media** - Greenroofs used for stormwater treatment credit must use a pollution control media layer. The pollution control layer is at least 1 inch in depth. This layer is to include materials known to adsorb pollutants such as phosphorus, nitrogen, metals or other pollutants of concern for the installation site. Pollution control media shall meet all of the following specifications.
 - All soil media mixes must display no acute toxicity at the applied media mix.
 - Unit Weight is no more than 45 pounds per cubic foot when dry.
 - No more than 5% of the particles passing the #200 sieve.
 - Over 50% mineral by volume and contains no shale.
 - At least 1 inch in thickness.
 - Water holding capacity is at least 30%, and as measured by porosity.
 - Permeability is at least 1.5 inches per hour. Permeability is vertical hydraulic conductivity at the specified unit weight noted above.
 - Organic content is no more than 10% by volume.
 - pH is between 6.5 and 8.0.
 - Soluble salts are less than 3.5 g (KCL)/L.
 - Sorption capacity exceeds 0.005 mg OP/mg media.
6. **Growth Media** - The growth media is intended to be the main support coarse for the vegetation. The growth media is installed on top of the separation fabric. Growth media shall meet all of the following specifications.
 - Unit Weight is no more than 45 pounds per cubic foot when dry.’

- No more than 10% of the particles passing the #200 sieve.
 - Contains no shale.
 - At least 3 inches in thickness.
 - Water holding capacity is at least 30%, and as measured by porosity.
 - Permeability is at least 1.5 inches per hour. Permeability is vertical hydraulic conductivity at the specified unit weight noted above.
 - Organic content is no more than 10% by volume.
 - pH is between 6.5 and 8.0.
 - Soluble salts are less than 3.5 g (KCL)/L.
7. **Preventing wind uplift** – To assure that a greenroof built in Florida remains operable, the greenroof must be designed to prevent wind uplift. A three-dimensional netting made of polyamide (nylon) filaments connected together woven into the growth media layer or other equivalent method is acceptable. As an alternative, a parapet of sufficient height can be used. For buildings less than 100 feet tall, a parapet height of 36 inches can be used in place of wind netting.
8. **Vegetation** – [Florida-friendly](#) or native vegetation is recommended on greenroofs used for stormwater treatment. Low maintenance plants and drought tolerant plants are recommended but not mandatory because of the use of stored stormwater for irrigation. However, plants tolerant to high levels of direct sunlight and high temperatures are necessary for the success of a healthy greenroof plants. Care should be made to ensure that the available root zone of the greenroof is sufficient for the intended plants. When designing an intensive greenroof, larger plants with more rigorous maintenance schedules are acceptable. Plants must achieve at least 80% cover of the greenroof area within one year of planting. When the vegetation density is less than 80%, new plants shall be added. Table 5.10.1 includes plants that have been successfully used on greenroofs in the different parts of Florida. Other plants are acceptable and applicants are encouraged to consult landscape architects and native nursery personnel for appropriate plants. Note for plants used on greenroofs in coastal areas, salt tolerance is an important consideration. Some examples of plants used along the coast are Simpson stopper, Snake plant, Muhly grass, Inkberry, and Beach sunflower.

Table 5.10.1. Plants that have been successfully used on greenroofs in Florida

<i>PLANT</i>	<i>NORTH FL</i>	<i>CENTRAL FL</i>	<i>SOUTH FL</i>
Muhly grass	X	X	X
Butterfly Weed		X	X
Blanket Flower	X	X	X
Sunshine mimosa		X	X
Perennial peanut	X	X	X
Snake weed		X	X
Asiatic Jasmine	X	X	X
Simpson Stopper		X	
Black Eyed Susan	X	X	
Beach Sunflower	X	X	X

9. **Irrigation** - Irrigation is required on all greenroofs in Florida to assure plant survival and to recover the required treatment volume. A rain sensor is required to monitor rainfall and the need for irrigation. Drip irrigation applied at the growth media surface is required, usually with one foot on-center spacing. Irrigation pumps must be installed with an alarm system to signal any mechanical problems. Irrigation will vary by season and a rain shut-off sensor is required. Flow meters shall be installed as a means of documenting when irrigation occurs and the volume of water used for irrigation. The addition of make-up water will be required during parts of the year depending on local rainfall patterns and records must be kept to document how much make-up water is added. The recommended source of make-up water is stormwater or gray water, whenever available. An in-line filter is recommended to reduce the maintenance problems and cost of irrigation line replacement. Depending upon the greenroof retention volume and design, irrigation shall occur three to four times per week with a maximum total application of one (1.0) inch per week if filtrate or stormwater are available.
10. **Roof Drain** - The greenroof must drain into a storage device, typically a cistern. The slope of the roof must be at least $\frac{1}{4}$ inch per foot. The primary drain can be an interior drain or gutter drain. A one-foot barrier must be maintained around the drain to prevent vegetation and debris from clogging drain as well as providing easy inspection. This barrier can be an aluminum break or a washed river stone section. An overflow shall also be provided to ensure drainage in the event that a clog occurs in the primary drain.
11. **Cistern or Other Water Storage Area** - The cistern or other water storage area serves to store filtrate for use as irrigation. Filtrate volumes in excess of those required for irrigating the greenroof can be used to either irrigate ground level landscaping or can be directed to other retention BMPs that allow for infiltration. If there is a discharge to a wet detention system, then the greenroof efficiency must be calculated using the BMP Treatment Train equations. Cistern or other storage placement can be below ground or above ground. If an above ground cistern is used it must be UV stable, dark in color, and must be placed in areas of low to no direct sunlight. Direct sunlight may cause irrigation water temperature to get too hot for plants.

5.10.6. Design Criteria for Management of the Filtrate

There are two common designs for management of the filtrate. The first design is to collect filtrate from a greenroof in a cistern. The cistern has no other water inputs except for supplemental makeup water. It is also not open to the atmosphere. Water in the cistern is used to irrigate the greenroof, or other nearby landscaping, or can be used for other non-potable purposes. Cistern annual volume reduction equations and graphs as a function of cistern storage were developed and are used to estimate retention as a function of the storage volume. For this design management of filtrate, the yearly mass reduction is equal to the yearly volume reduction. Cistern design curves are provided in [Section 5.10.9](#) of this Manual for greenroofs and for irrigation rates commonly used in Florida. The design curves provide the amount of cistern storage required for a specified annual retention of rainfall or reduction in discharge from the greenroof and cistern system.

The second design condition is when the greenroof filtrate is discharged from the roof into a conveyance system or into another BMP such as a wet detention pond. For this case, the removal of the nutrient is proportional to the removal effectiveness of the pond. However, note that the flow to the pond without a cistern is reduced by 44%.

5.10.7. Construction requirements

1. To assure proper construction of the greenroof/cistern system the following construction procedures are required:

2. Construct the greenroof in accordance with permitted design plans and specifications.
3. Be sure that all greenroof waterproofing components are properly installed before placing any of the media on the greenroof.
4. Be sure all equipment and plants are properly sited per design drawings and installed properly.
5. Construct the irrigation system in accordance with all permitted design specifications and irrigation system design standards.
6. Assure that all irrigation components are properly sited and that irrigation spray heads are working properly and not spraying irrigation water onto impervious areas.

5.10.8. Inspections, Operation and Maintenance

Maintenance issues associated with greenroof with cistern systems are related to the health of the plants, the drainage capabilities of the system, and proper functioning of the irrigation system.

Greenroof with cistern systems must be inspected annually by the operation and maintenance entity to determine if it is operating as designed and permitted. Reports documenting the results of annual inspections shall be filed with the County every three years.

A. Inspection Items:

- Inspect operation of the greenroof/cistern system to assure that rainfall is flowing properly through the greenroof and into the cistern.
- Inspect the plants on the greenroof to assure they are healthy and growing. Assure plants are covering at least 80% of the surface area of the greenroof and that plant species not on the approved plant list are not becoming established.
- If an intensive greenroof, inspect it for damage by foot traffic or other human uses of the greenroof.
- Inspect the operation of the pumping system and the irrigation system to assure they are working properly.

B. Maintenance Activities As-Needed To Prolong Service:

- Repair any components of the greenroof drainage system which are not functioning properly and restore proper flow of stormwater or filtrate.
- Maintain the plants on the greenroof on an as needed basis to assure healthy growth and meet the required 80% coverage of the greenroof. Weeding to remove plants not on the approve design plant list will be needed on a regular basis. Whenever plant coverage is less than 80%, new plants shall be established as soon as possible.
- Repair any damage to the greenroof by foot traffic or other human uses.
- Repair or replace any damaged components of the pumping and irrigation system as needed for proper operation.

C. Record Keeping

The owner/operator of a greenroof/cistern system must keep a maintenance log of activities that is available at any time for inspection or recertification purposes. The log will include records related to the use of the filtrate water for irrigation to demonstrate that the permitted nutrient load reduction is being achieved. A flow meter to measure the quantity and day/time of irrigation is required. Visual observations of the success of plant growth and cover, including photo documentation is also required. The maintenance log shall include the following:

- Irrigation volume measured using a flow meter specifying the day and amount;
- Cistern overflow volumes and makeup water volumes;
- Observations of the irrigation system operation, maintenance, and a list of parts that were replaced;
- Pruning and weeding times and dates to maintain plant health and 80% coverage;

- A list of dead, dying, or damaged plants that are removed and replaced;
- Maintenance of roof mechanical equipment;
- Dates on which the greenroof was inspected and maintenance activities conducted; and
- Dates on which fertilizer, pesticide, or compost was added and the amounts used.

5.10.9. Greenroof with Cistern - Harvesting Design Curves and Equations

A cistern or similar storage device is used with a greenroof to store the water and then the stored water is reused on the greenroof for irrigation. By doing this, the direct discharge to surface water is reduced. [Wanielista and Hardin \(2006\)](#) showed that a cistern designed to collect 5 inches of rainfall from a greenroof with pollution control media composed of a blend of tire crumb, was able to remove at least 90% of the mass of Soluble Reactive Phosphorus (SRP) and 98% of the mass of Nitrate Nitrogen. These removals were measured over one year and depend on the rainfall conditions in that year. The size of the cistern is dependent on local rainfall conditions and the rate of water used from the cistern.

Figure 5.10.2. Greenroof With Cistern Harvesting Design Curve for Niceville, Florida Area
 (Based on 1" irrigation/week using 46 years of data)

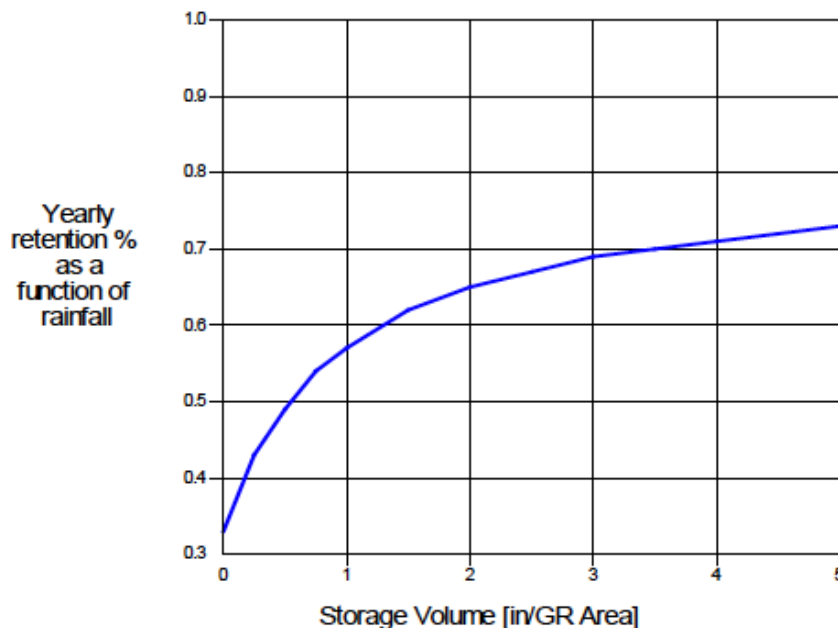

In the Niceville region, a greenroof with no cistern will retain 33% of the annual yearly runoff volume. The greenroof and cistern functions to attenuate, evaporate, and lower the volume of discharge coming from a roof surface. The greenroof system will also neutralize acid rain, reduce mass of pollutants, and attenuate hydrographs. The storage discharge design of the cistern determines the attenuation. A greenroof with cistern will achieve higher stormwater volume and load reductions (greater than 70%) than if used without a cistern (~ 40%). When used with a cistern, the cistern discharge will have less pollutant mass than discharge without a cistern. Design graphs have been developed for many locations in the State (Hardin, 2006 and Hardin and Wanielista, 2007). The greenroof with cistern harvesting design curves and equations for Escambia County (based on Niceville’s curve) are shown in Figures 5.10.2 and 5.10.3

Figure 5.10.3. Greenroof With Cistern Harvesting Equation for Niceville, Florida Area
 (Based on 1" irrigation/week using 46 years of data and with a cistern)

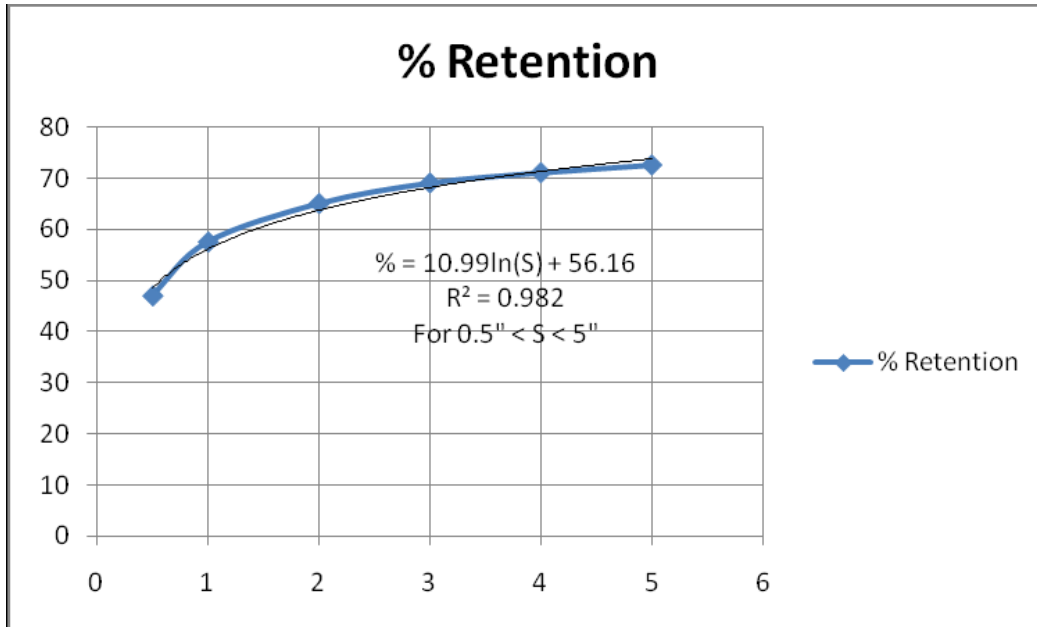

The design curves and equations are based on cistern storage values of between one-half inch (0.5") and five inches (5.0"). The upper storage limit of five inches was set because there is marginal improvement in pollutant removal above five inches. For example, in Pensacola, the yearly retention of a green roof with cistern system is:

$$\% \text{ RETENTION} = 10.99 \ln(S) + 56.16$$

If cistern storage is 2", this becomes:

$$\% \text{ RETENTION} = 10.99 \ln(2) + 56.16 = (10.99 * 0.69315) + 56.16 = 7.27 + 56.16 = 63.43\%$$

This is considerable larger than the 33% retention by the green roof alone greatly increasing the average annual retention volume and pollutant load reduction.

5.11. Rainwater Harvesting

5.11.1. Description

The term “rainwater harvesting” most commonly refers to water collected from roofs that is stored and reused. Rain is a free source of relatively clean, soft water. As rain falls onto surfaces such as concrete, pavement, and grass it contacts more contaminants than it would from dry fallout on a roof. Harvesting rainwater from roof runoff is an easy, inexpensive way to disconnect impervious surfaces and capture water before it has contacted many potential contaminants. The purpose of capturing and reusing stormwater is to replace the use of potable water. Usually harvested rainwater is reused for outdoor irrigation, and the cost of using it in new developments has been estimated to be about 5-25% of the cost of potable water. Harvested rainwater can be used for a variety of uses ranging from outdoor irrigation and car washing to indoor uses including toilet flushing, clothes washing, irrigation of indoor planters, hose bibs, car washing, and potable use. However, most of these indoor uses require approval of the Escambia County Health Department and Planning Department.

Escambia County receives approximately 65 to 66 inches of rainfall per year. Based on this, a typical 2000 square foot roof can produce 81,000 to 82,000 gallons of water, adequate for residential grey water use and reasonable irrigation needs. The American Rainwater Catchment Systems Association (ARCSA) certifies professionals in design and construction of rainwater harvesting systems, and offers workshops at 3 levels of expertise. They have a web site at <http://www.arcsa.org/>

There are four types of rainwater harvesting systems:

- Small residential systems that store rainwater in rain barrels for supplemental irrigation.
- Large residential or commercial systems that store rainwater in a cistern for irrigation, vehicle washing, dust control, or other outdoor, non-potable uses.
- Large residential or commercial systems that store rainwater in a cistern as a source of indoor graywater uses such as toilet flushing, urinal flushing, Heating Ventilating and Air Conditioning (HVAC) make-up water, laundry wash water, and outdoor non-potable uses.
- Residential or commercial systems that store rainwater in a cistern as a source of potable water.

RAINWATER HARVESTING SUMMARY

Advantages/Benefits	Reduces site DCIA, stormwater volume, pollutant loadings; reduces potable water use and reuses rainwater for irrigation and other nonpotable purposes; provides ground water recharge and water reuse.
Disadvantages/Limitations	May require a pump, flow meter, and filtration system, depending on the determined uses of harvested rainwater.
Volume Reduction Potential	Moderate to High depending on roof area and storage volume
Pollutant Removal Potential	Moderate to High for all pollutants, directly related to the average annual volume captured and retained on-site.
Key design considerations	Only for managing roof runoff. Calculate roof area and annual stormwater volume; determine use for harvested rainwater (irrigation, graywater, potable); determine harvesting rate, volume, irrigation method, and equipment; obtain additional requirements for graywater or potable use from Escambia County Health

	Department; recovery of treatment volume within 24 – 72 hours;
Key construction and maintenance considerations	Ensure underground cisterns or storage vaults are protected against buoyant forces;

1. **Type 1. Non-potable Residential System with a Rain Barrel** - The first type of system is a small residential system that stores rainwater in rain barrels. These systems allow homeowners to retrofit their homes to reduce runoff and the amount of potable water consumed for irrigation. Many sources of information on designing and installing these systems are available on the internet:

- <https://www.scgov.net/AirAndWaterQuality/Pages/RainBarrel.aspx>
- <http://www.swfwmd.state.fl.us/conservation/rainbarrel/>
- <http://sarasota.ifas.ufl.edu/FYN/Rainbarrel.shtml>

Information and rain barrels also are available at home centers. **The use of rain barrels for rainwater harvesting is not an acceptable BMP for meeting ERP requirements.** However, it is a good way for homeowners to reduce stormwater pollution and potable water use for irrigation.

2. **Type 2. Non-potable System for Outdoor Use with a Cistern** - The second type of system is a large commercial or residential system that uses a cistern or other permanent storage tank to store water for irrigation and/or other nonpotable uses. In these systems:

- Rainwater is collected by gutters and scuppers and routed through downspouts to a cistern.
- The downspouts are equipped with a device to divert the first flush of water away from the cistern and to screen out large material such as leaves.
- Cisterns typically are larger than 80 gallons and may provide aboveground or underground storage. If the cistern is underground, it must be constrained against buoyant forces.
- The irrigation system will likely require additional filtration and screening to prevent valves and spray heads from clogging.
- The harvested rainwater will require a pumping system to distribute the water. The components for this type of system are shown in the adjacent figure.

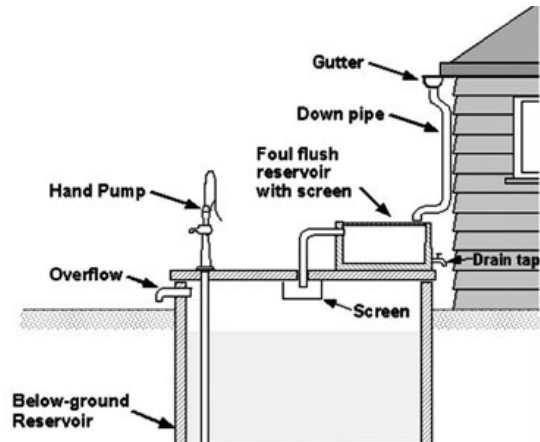

3. **Type 3. Non-potable System for Indoor and Outdoor Use with a Cistern** - The third type of system is a large residential or commercial system that stores rainwater and graywater in a cistern for indoor uses such as toilet flushing, urinal flushing, HVAC make-up water, laundry wash water, and other outdoor uses. In these systems:

- Rainwater is collected by gutters and scuppers and routed through downspouts to a cistern. Graywater is collected by internal plumbing and routed to the cistern.
- The downspouts are equipped with a device to divert the first flush of water away from the cistern and to screen out large material such as leaves.

- Cisterns are larger than 80 gallons and may provide aboveground or underground storage. If the cistern is underground, it must be constrained against buoyant forces.
- The harvested rainwater will require a pumping system to distribute the water.
- Indoor graywater (flushing and laundry) systems require disinfection, pre-filtering and fine filtering to between 5 and 20 microns.

This type of system has a potential for inadvertent human contact or consumption. Therefore, the system has additional requirements from the Escambia County Health and Building Departments. The components for this type of system are shown below.

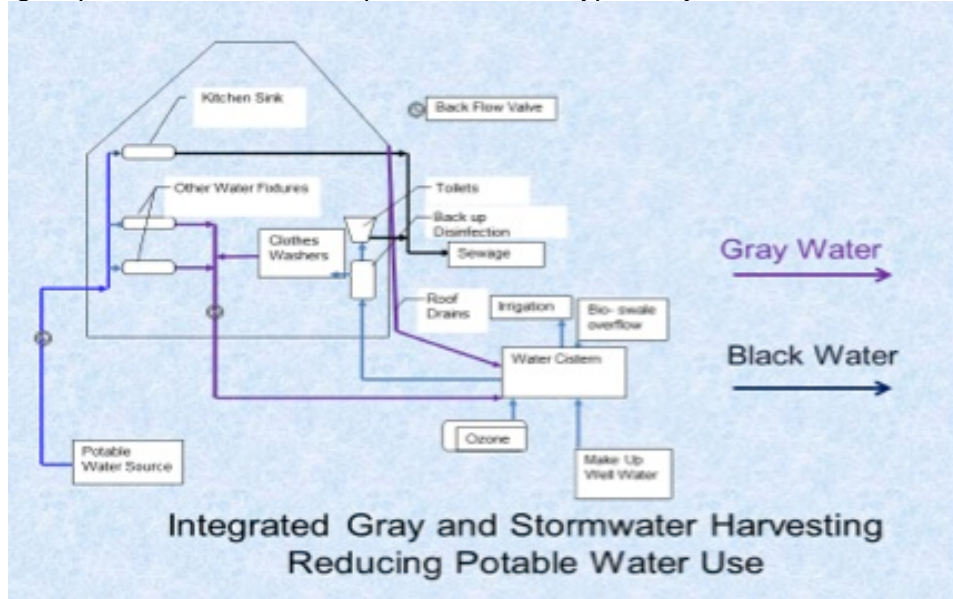

5.11.2. Applicability and Siting Considerations

A Rainwater Harvesting System is primarily designed to store and supply roof rainwater for use in lieu of high-quality potable water. They can be used on commercial, residential, and industrial areas. The cistern storage volume provides stormwater benefits along with nonpotable water that can be used for numerous purposes. Due to the relatively small volume of roof runoff and the extreme variations in storm intensity and duration, rainwater harvesting does not provide peak discharge rate attenuation. While rain is a relatively clean source of water, the initial runoff from a roof can contain dust, fecal material, and particulate matter that accumulate on the roof. This initial runoff is diverted from the cistern by the first-flush diverter. Rainfall is a source of nitrogen from atmospheric deposition. Harvesting rainfall results in a reduction in the nitrogen load as well as other pollutants. To achieve a desired average annual load reduction, the cistern must be designed with the target annual average volume reduction, harvesting rate, and water use rate, in mind.

The roof must have gutters or drains with the appropriate screens to collect the rainwater. The site must have adequate space for a cistern and may need to be anchored to a structure. There must be a use for the harvested rainwater. A makeup water source may be required for periods of low rainfall. Stormwater and graywater (including air conditioner condensate) are the first choices for irrigation systems. Make-up water within an occupied space will likely be potable water. Potable water supplies must be separated using a backflow prevention device. An air gap is preferred.

5.11.3. Required Treatment Volume

Since a Rainwater Harvesting System is only used to capture roof runoff, a relatively small part of the overall runoff in a development, **it functions as a component of a [BMP Treatment Train](#)**. Accordingly, it will only provide part of the required pollutant load reduction. The rainwater harvesting storage volume may be determined by calculating the volume of water necessary to sustain the desired water use: irrigation, graywater, or potable water supply. The applicant will size the cistern to satisfy the water-use demand. Using the calculated cistern volume, the applicant may then calculate the harvesting rate normalized to the roof catchment area. This volume is used to determine a runoff-capture efficiency using the curve provided in Figure 5.11.1. It should be noted that **Figure 5.11.1 is a Rate Efficiency Volume (REV) curve for a constant daily water demand in Escambia County**. If the daily demand is expected to vary by more than 10%, either the lowest expected daily demand must be used on Figure 5.11.1 or the average annual reduction in runoff from the roof must be demonstrated using a continuous simulation based on at least 20 years of rainfall data.

Figure 5.11.1. Rate Efficiency Volume (REV) Curve for a Rainwater Harvesting System in Escambia County with Constant Daily Demand

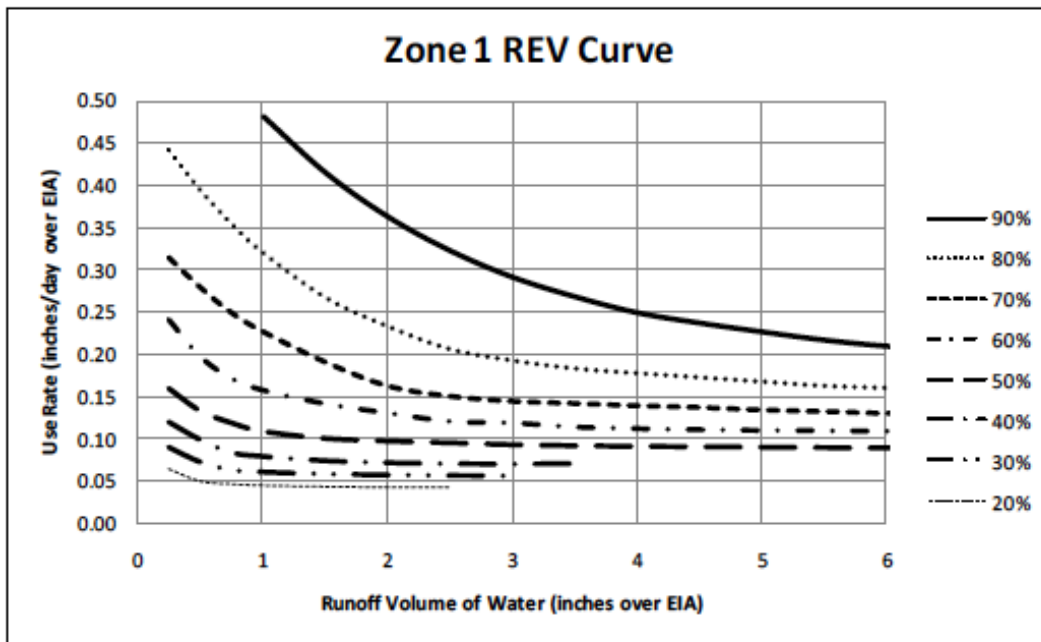

5.11.4. Design Criteria

The following criteria are considered minimum standards for the design of a rainwater harvesting system for stormwater credit in Escambia County. The applicant should consult with the appropriate WMD, the [Florida Building Code for Plumbing](#) (Florida, 2014), or its successors, and the Escambia County Health Department to determine if there are any variations to these criteria or additional standards that must be followed.

1. Catchment System

- The gutters, downspouts, drains, and pipes for the collection system must be directed to a cistern.
- Gutters and drains must be protected and covered with a removable screen to prevent debris from clogging drains.

- For every inch of rain that falls on a roof area of 1,000 square feet, approximately 600 gallons of rainwater may be collected. One inch of rain falling on a square foot surface yields approximately 0.6 gallons of water. As a result of water loss in the system, it is estimated that about 75% of the harvested rainfall can be captured or 0.46 gallons.
- The first flush of rainwater, equivalent to the first gallon of runoff per 100 square feet of roof area, must be discarded after each rain event to ensure only the cleanest water is stored in the cistern. This is accomplished by installing a first flush diverter before the cistern, typically within the downspout. The diverted rainwater is routed to a vegetated area such as a rain garden. Several manufacturers offer proprietary first-flush diverters; some of these diverters use a vortex to separate debris while reducing the need for maintenance. A schematic of a simple first-flush diverter is shown below.

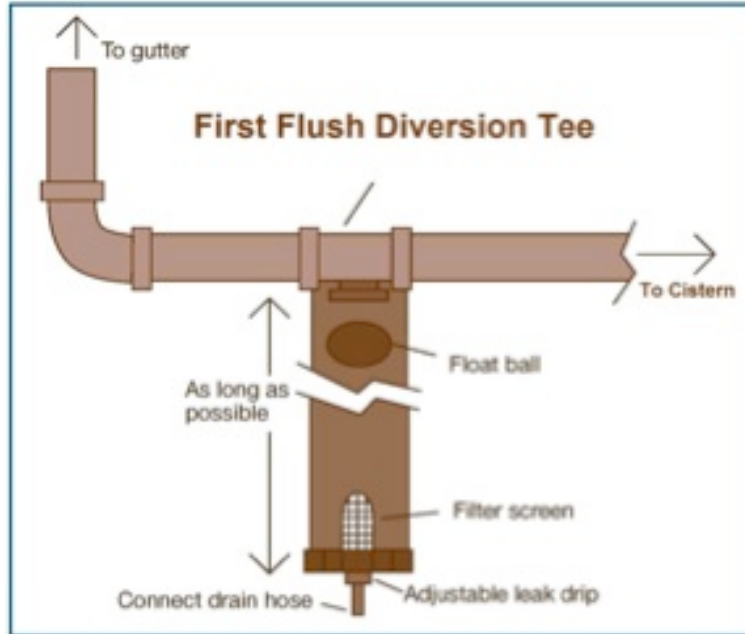

2. Filtering System

- Irrigation systems require pre-filtering to remove particles that may affect valve and sprinkler operation. The filtering system should be designed in accordance with the requirements of the irrigation system.
- Indoor graywater (flushing and laundry) systems require pre-filtering and fine filtering to between 5 and 20 microns.

3. Cistern

- The cistern may be installed below or above ground. If aboveground storage is used, it must be UV stable. The cistern must inhibit algal growth without biocides or toxic substances. This criterion may be met simply with an opaque tank.
- The installation must follow the Florida Building Code for Plumbing and the [Florida Building Code for Electrical](#).
- Prevention of unintentional entry by humans or vermin must be part of the design. Also inspection and cleaning access with venting and appropriate safety signs must be provided.
- The water supply line (e.g., irrigation line or graywater line) must be metered and have a filter.
- An overflow drain is required. It must be sized to accommodate the 100-year/ 24-hour design storm flows. The appropriate downstream erosion controls must be made.

- The cistern size (dedicated water volume) must be determined based on the water use.
 - An auxiliary back-up water supply must be provided. Graywater (including air conditioner condensate) is preferred for irrigation systems, but other sources should be considered. If reclaimed water is used, it must be fully used during the intended irrigation cycle and proper signage should be added.
4. Irrigation system
 - Irrigation water is supplied from a cistern.
 - Irrigation rates and timing must comply with current watering restrictions.
 - Rain sensors or soil moisture sensors for irrigation shut off must be provided.
 - Watering restrictions are applicable to irrigations systems supplied with rainwater.
 - Backflow prevention devices on any auxiliary back-up source must be provided.
 5. Graywater system
 - Asphalt shingles and cedar shakes may not be used as a roofing material for the catchment area for a graywater or potable water system. These materials can leach potentially toxic materials such as copper oxide and petroleum products. (Texas, 2007)
 - Harvested rainwater is supplied from a cistern for graywater use within an occupied space.
 - Filters are required between the pump and the connection to the plumbing system to provide pre-filtering and fine filtering to between 5 and 20 microns.
 - Backflow prevention devices on any auxiliary back-up source must be provided.
 - The Escambia County Health Department and the Escambia County Development Services must approve all Rainwater Harvesting Systems that connect to a plumbing system within an occupied space. These systems may have additional design and maintenance requirements.
 6. Discharge Requirements - A Rainfall Harvesting System typically will have two discharges: the water diverted from the first flush and the cistern overflow. The appropriate erosion control must be made downstream of both discharges. Where possible, the first-flush water must be discharged to a rain garden or other landscaped area.
 7. Safety Considerations - Safety considerations to be addressed for all rainwater harvesting designs include but are not limited to the following:
 - Access to the pump and cistern must be controlled.
 - Safety features may include fencing and signage depending on the site and use of water.
 - Depending on the end use, electrical back-up when there is no power is recommended as part of emergency operations.
 - All pipes that transport water for harvesting must be labeled as 'Non-potable. Do not drink.' unless the system is approved by the Escambia County Health Department for potable use.
 - Large cisterns and vaults may require entry for maintenance and inspection. Entry of vaults for inspections is a potentially unsafe activity due to anoxic conditions. This may require an OSHA Confined Entry permit and breathing apparatus.
 - These systems must provide appropriate safety equipment for a confined space.
 - The Rainwater Harvesting System must be separated from the potable water supply with a backflow prevention device, preferably consisting of an air gap.
 8. Additional Design Considerations - A Rainfall Harvesting System may include the following, depending on the system's design:
 - Lighting and electrical outlets.
 - Signage with education and safety language.
 - A leak detection system for the cistern.

9. Additional Permitting Considerations
 - The rainwater harvesting system may require a NFWFMD water use permit.
 - The rainwater harvesting system may require a permit from the Escambia County Health Department.
 - The rainwater harvesting system will require a permit from the Escambia County Development Services to include electrical, plumbing, and structure anchoring.

5.11.5. Construction Requirements

Rainwater harvesting systems typically are used in conjunction with rain gardens and secondary water uses such as irrigation. To assure proper construction of the stormwater harvesting system the following construction procedures are required:

1. Install the Catchment System including the gutters, screens, diverter, and cistern.
2. Construct the rain garden or landscaping area that will receive the first flush discharge and ensure that it is stabilized with appropriate vegetation before operation begins.
3. Construct the associated irrigation system in accordance with all permitted design specifications and irrigation system design standards. If appropriate, construct the components of the nonpotable or potable uses for rainwater in accordance with all design and code specifications.
4. Assure that all irrigation components are properly sited and that irrigation spray heads are working properly and not spraying irrigation water onto impervious areas.
5. Test all components of the system to ensure there are no leaks or other malfunctions.

5.11.6. Inspection, Operation, and Maintenance

Maintenance issues associated with Rainwater Harvesting Systems are related to the proper functioning of the filter system and of the pump and irrigation system. Rainwater Harvesting Systems must be inspected regularly by the operation and maintenance entity to determine if it is operating as designed and permitted. Reports documenting the results of annual inspections shall be filed with the County every two years.

A. Inspection Items:

- Inspect operation of the Rainwater Harvesting System to assure that the pump, flow meter, and filter system are operating properly and achieving desired flow volumes.
- Inspect the operation of the Rainwater Harvesting System to assure proper operational and, with respect to the irrigation system, inspect the pump, timer, distribution lines, and sprinkler heads to assure they are working properly.

B. Maintenance Activities As-Needed To Prolong Service:

- Repair any components of the Rainwater Harvesting System that are not functioning properly and restore proper flow and filtration of stormwater.
- Repair or replace any damaged components of the Rainwater Harvesting System and irrigation system as needed for proper operation.

C. Record Keeping

The owner/operator of a Rainwater Harvesting System must keep a maintenance log of activities that is available at any time for inspection or recertification purposes. The log will include records related to the operation of the Rainwater Harvesting System and the use of the harvested rainwater for irrigation or other approved purposes to demonstrate that the permitted nutrient load reduction is being achieved. A totalizing flow meter to measure the quantity and day/time of pumping and irrigation is required. The maintenance log shall include the following:

- Rainwater volume harvested using a flow meter specifying the day, time, and volume;

- Rainwater volume irrigated or otherwise used using a flow meter specifying the day, time, and volume used;
- Observations of the Rainwater Harvesting System operation, maintenance, and a list of parts that were replaced;
- Observations of the irrigation system operation, maintenance, and a list of parts that were replaced; and
- Dates on which the Rainwater Harvesting System and irrigation (or other use systems) were inspected and maintenance activities conducted.

5.12. Stormwater Harvesting Systems

5.12.1. Description

Stormwater harvesting systems use treated stormwater for beneficial purposes thus reducing the stormwater volume and mass of pollutants discharged from a retention or wet detention system. It is most often used with wet detention as part of a BMP treatment train. The harvested stormwater can be used for numerous uses including irrigating lawns and landscape beds, irrigating green roofs, washing vehicles, industrial cooling and processing, and toilet flushing. To properly design a stormwater harvesting system that will result in a predictable average annual mass removal, water budgets are required. A water budget is an accounting of water movement on to, within, and off of an area. The development of a water budget for stormwater harvesting is done to quantify the reduction in offsite discharge for a given period of time. Individual components of storage volume, rate of use, and discharge can be accounted for in the water budget. Calculation of these components requires knowledge of many variables, such as: watershed characteristics, water use volumes and rates, desired percentage of stormwater runoff to be used, maximum volume of stormwater runoff storage, rainfall data, and evaporation data.

The results of long-term simulations of stormwater harvesting ponds over time are presented as Rate-Efficiency-Volume (REV) curves. The REV curves are used to design stormwater harvesting systems to improve the nutrient removal effectiveness of wet detention ponds allow them to meet the performance standards described in [Section 4.3](#) of this Manual. Stormwater harvesting curves (REV curves) are provided in [Section 5.12.7](#) of this Manual.

Important assumptions that must be understood when using the REV curves include:

- Net ground water movement into or out of the pond is assumed to be zero over the period of simulation.
- The use rate is kept constant for each month in a year, and presented on the REV curves as an average rate per day and over the equivalent impervious area (EIA).
- Irrigation is limited to twice per week with no irrigation after rainfalls equal to or greater than the daily irrigation amount.
- Irrigation on lands within the drainage basin of the wet detention system from which stormwater is being harvested will result in a lower volume and pollutant loading reduction.
- The effectiveness results are long term averages based on historical rainfall records. The average values for each year will be different because of annual rainfall volumes and distribution.
- Soil storage in the irrigated area and plant ET are not limiting irrigation application rates.

It should be noted that a supplemental water supply is needed in the dry season when the pond harvested volume is typically depleted. Also, if the stormwater harvesting system design does not meet one of the above assumptions, the applicant can develop a site specific water budget analysis to meet the required performance standard and design criteria.

STORMWATER HARVESTING SYSTEM SUMMARY

Advantages/Benefits	Reduces the volume of stormwater discharged from a wet detention system thereby increasing treatment effectiveness; reduces potable water use and reuses stormwater for irrigation and other nonpotable purposes; provides ground water recharge and water reuse.
---------------------	---

Disadvantages/Limitations	Requires a pump, flow meter, and filtration system, depending on the determined uses of harvested stormwater; need area to be irrigated or other use of the water; may require a Consumptive Use Permit (CUP).
Volume Reduction Potential	Moderate to High depending on use for harvested stormwater, size of irrigation area, and irrigation rate and schedule.
Pollutant Removal Potential	Moderate to High for all pollutants
Key design considerations	Determine use for harvested stormwater (irrigation, graywater, potable); determine equivalent impervious area, harvesting rate, volume, irrigation method, and equipment; use Rater-Efficiency-Volume (REV) curve to specify storage volume and harvesting rate; filter harvested stormwater through horizontal wells or equivalent filter systems; obtain additional requirements for graywater or potable use from Escambia County Health Department; recovery of bleed-down volume within 24 – 30 hours;
Key construction and maintenance considerations	Ensure proper construction of retention or wet detention system; assure that all components of the harvesting and reuse system are properly sited and operational; ensure irrigation spray heads do not direct water onto impervious surfaces; inspect all components of system on regular basis to ensure proper operation; maintain pumping and irrigation records as required.

5.12.2. Treatment required

The required nutrient load reduction will be determined by the applicable Performance Standard in [Section 4.3](#), or by the NFWFMD ERP requirements. The nutrient removal credits associated with stormwater harvesting are calculated using the REV Curves and the BMP Treatment Train Equations set forth below. The BMPTRAINS software may be used to evaluate the nutrient removal load reduction credits.

5.12.3. Equivalent Impervious Area

When designing stormwater harvesting systems, the runoff characteristics of the watershed must be calculated. The overall runoff coefficient (C) for an area composed of different surfaces can be determined by weighting the runoff coefficients for the surfaces with respect to the total areas they encompass, and is based on the rainfall volume used to calculate the maximum volume for use.

$$C = \frac{C_1 A_1 + C_2 A_2 + \dots + C_N A_N}{A_1 + A_2 + \dots + A_N} \quad \text{Equation 5.12.1}$$

where: C_N = Runoff coefficient for surface N
 A_N = Area of surface N

This weighted runoff coefficient (C) is termed the effective runoff coefficient and is representative of the entire watershed.

The equivalent impervious area (EIA) is equal to the product of the total area of the watershed (A) and the effective, or weighted, runoff coefficient (C) for the watershed:

$$EIA = CA \quad \text{Equation 5.12.2}$$

where: EIA = Equivalent impervious area (acres)
 C = Effective runoff coefficient for the watershed
 A = Area of watershed (acres)

The area of the EIA is defined as the area of a completely impervious watershed that would produce the same volume of runoff as the actual watershed. For example, a 20 acre watershed with an effective runoff coefficient (C) of 0.5 would have an EIA of 10 acres (20 ac x 0.5). If one inch of rain fell on this 10 acre impervious area, the runoff volume would be 10 ac-in (10 ac x 1 in). If the same amount of rain fell on the actual watershed the runoff volume would not change:

$$20 \text{ ac} (1 \text{ in}) (0.5) = 10 \text{ ac-in}$$

The EIA will be expressed in acres when using this methodology. The use of the EIA serves to generalize the model so that it can be applied to a watershed of any size and runoff characteristics or as applied to a volume of water used. The product of inches of water used and the area is a volume term. The EIA for a watershed shall include the area of the pond when using this methodology.

Figure 5.12.1 Typical Cross Section of a Stormwater Harvesting System

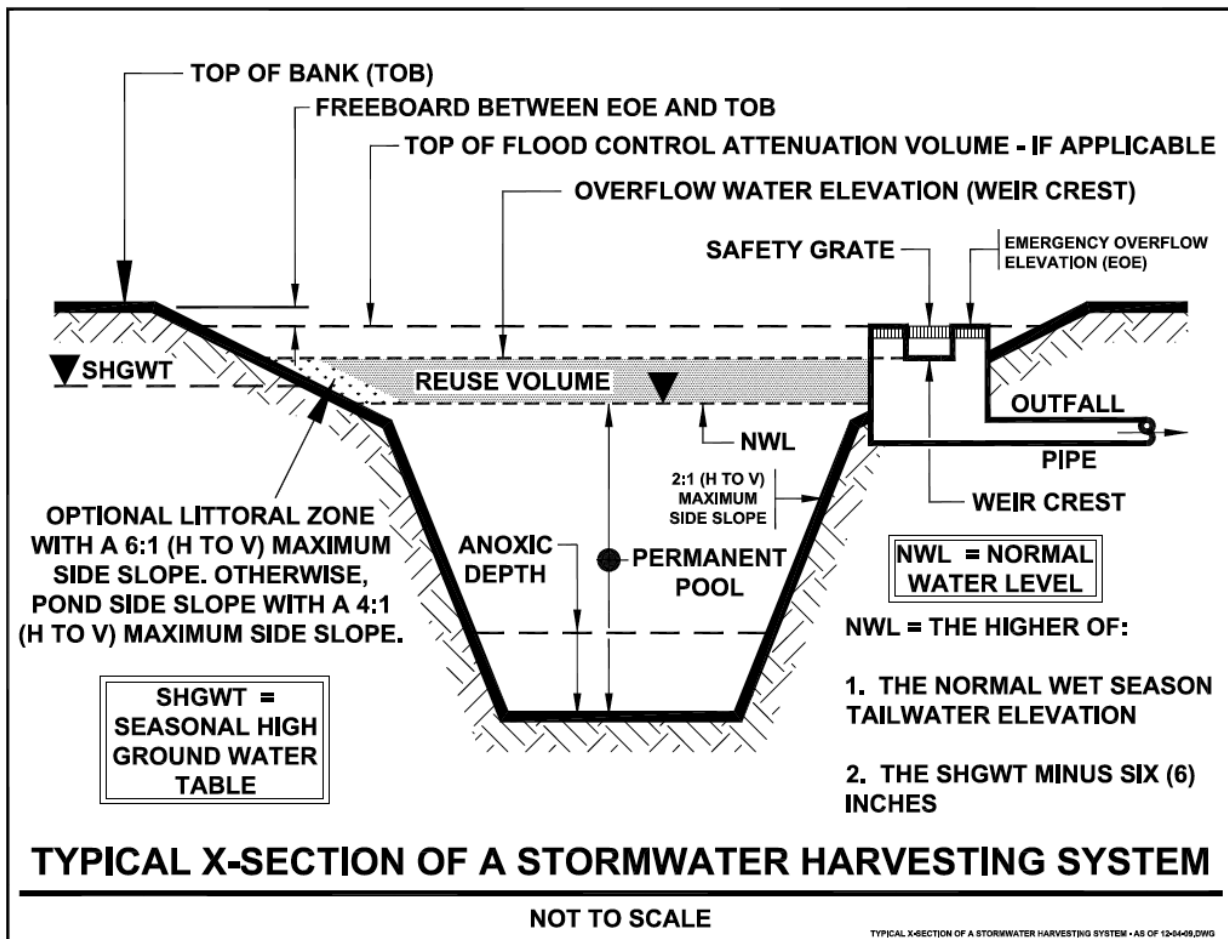

5.12.4. Design Criteria

1. The wet detention design criteria in Section 8 of the NFWFMD’s [Applicant’s Handbook Volume II](#), with the exception of 8.1-1, 8.4-1,8.4-2 and 8.4-3, are applicable to stormwater harvesting systems.
2. The stormwater harvesting system shall be designed using the Rate-Efficiency-Volume (REV) Curves and methodology set forth in [Section 5.12.7](#) of this Manual.
3. **Runoff Storage Volume** - The runoff storage volume (V) is similar to the “bleed down volume” or the temporary storage volume in a wet detention pond (Figure 5.12.1). The major difference between a stormwater harvesting pond and a wet detention pond is the operation of the temporary storage volume. For typical wet detention systems, the bleed-down volume is discharged to adjacent surface waters using a flow limiting structure. On the other hand, in a stormwater harvesting pond the runoff storage volume is not discharged to adjacent surface waters but is used for some beneficial purpose.

Runoff storage volumes are expressed in units of inches over the *EIA*. The values can be converted to more commonly used units such as acre-feet or cubic feet using simple conversions. It should also be noted that in most cases, stormwater harvesting can provide for most of the water needed but the runoff storage volume will not be sufficient to supply all the water needed over a year, especially in dry periods. Thus a backup supply should be planned. A back up supply is one that provides for less than the majority of water needed. If water is taken from the permanent pool of the wet detention system for irrigation, the applicant must demonstrate that the lowering of the permanent pool will not adversely affect surface waters or wetlands.

4. **Minimum Quality of Harvested Stormwater** – Treated harvested stormwater that is used for irrigation is withdrawn from the stormwater treatment system in a manner that minimizes turbidity, bacteria, pathogens and algal toxins. This can be done by filtering the stormwater to be harvested through a minimum of four (4) feet of native soils or clean sands. This can be accomplished by withdrawing water through a horizontal well configuration located directly adjacent or under the stormwater harvesting pond or by the use of a mechanical sand or disc filter. See Figures 5.12.2 and 5.12.3 for a detailed schematic of approved withdrawal systems.

Figure 5.12.2. Schematic for a Typical Stormwater Harvesting Pond



(from FDOT BD 521-03, Regional Stormwater Facilities, December 2007)

Figure 5.12.3. Schematic for a Two Typical Stormwater Harvesting Withdrawal Systems

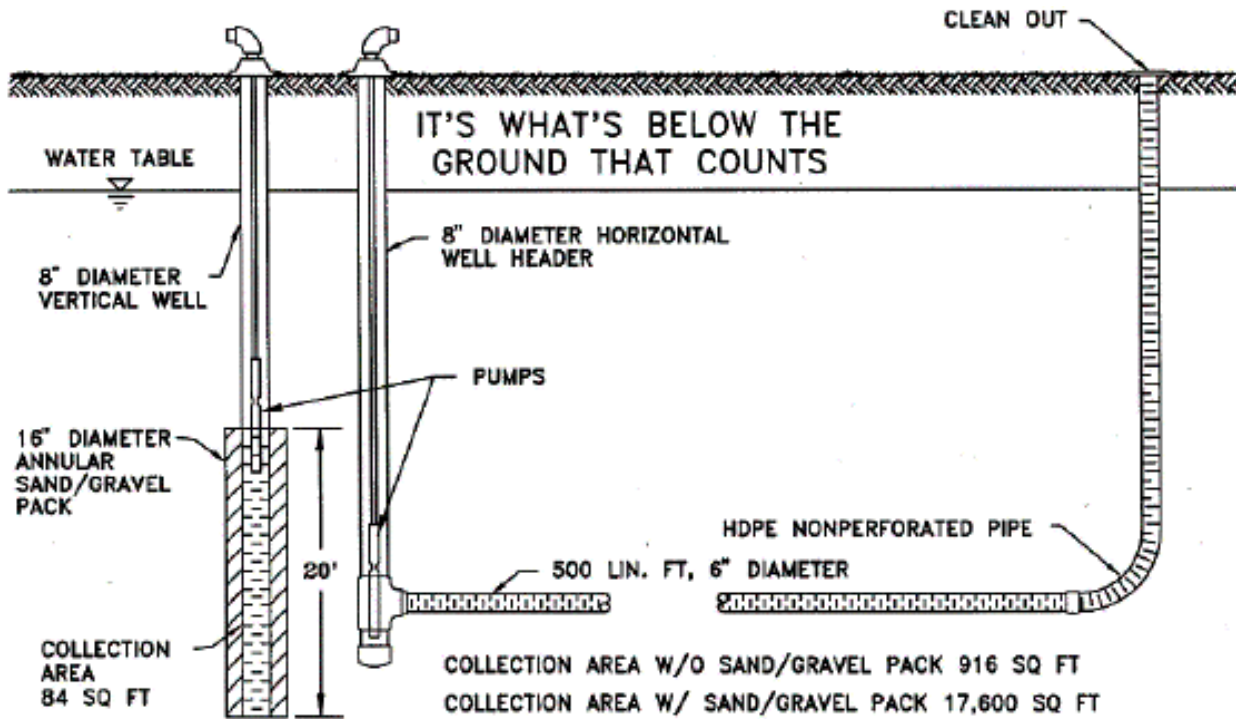

5. Withdrawal of irrigation water from the stormwater harvesting pond in this manner effectively removes algae, turbidity, and other solids that may clog spray heads and materials that may be considered a risk to human health when converted to an aerosol condition. Acceptable alternatives include in-pipe treatment filtration or a mechanical filter used to remove detained water from ponds. If an applicant proposes to use an alternative to horizontal wells, an affirmative demonstration must be made by the applicant, based on plans, test results, calculations or other information, that the alternative design is appropriate for their specific site conditions, will effectively remove turbidity, pathogens, and algae toxins to prevent adverse impacts.
6. **Acceptable Use Rates of Harvested Stormwater** - In addition to water quality considerations, stormwater harvesting systems shall be designed and operated in such a manner to prevent adverse impacts to wetlands or surface waters. A common application of the treated stormwater involves an area to be irrigated. For instance, an apartment complex may irrigate natural vegetation, turf grass, and other landscaped common areas. The average yearly demand of turf grass irrigation systems in Florida is usually less than one inch per week on the average over a year. The designer shall consult a landscape irrigation specialist for the design of the irrigation system and the recommended irrigation rates. **Applicants are advised that a WUP or CUP may be required for stormwater harvesting systems and that the use rates and design shall be consistent with WUP or CUP requirements.**
7. **Rate of Use and Metering of the Harvested Stormwater** - The rate of use (R) is a variable over time and must be recorded. On the REV curves, the rate of use units is expressed as an average inches per day over the EIA. The values can be converted to more practical units such as gallons per day or acre feet per week using simple conversions. A meter or other reporting device must monitor the use rate. The records of use must be documented in a logbook to demonstrate that the required pollutant load reductions (achieved through reduced volume of discharge) are being met.

8. The NFWFMD Applicant’s Handbook Section 12 also lists design criteria for stormwater harvesting systems that are compatible with the requirements in this section. However, the NFWFMD requires a littoral zone. Discussions with NFWFMD staff indicate that they are flexible on this requirement since stormwater harvesting reduces nutrient loading and the water is used mainly for irrigation.

5.12.5. Construction requirements

Stormwater harvesting systems typically are used in conjunction with wet detention basins. Therefore, the first step in constructing a stormwater harvesting system is to construct the wet detention basin in compliance with all permitted design specifications. To assure proper construction of the stormwater harvesting system, first follow the construction procedures for wet detention systems below then those for the stormwater harvesting component.

The following construction procedures are required to assure proper construction of the wet detention pond:

1. The location and dimensions of the wet detention system shall be verified onsite prior to its construction. All design requirements including detention pond dimensions and distances to foundations, septic systems, and wells need to be verified.
2. Once excavation of the wet detention pond begins, the soil types need to be verified to ensure that they are suitable for the system.
3. If the wet detention system is being created by construction of an embankment, rather than solely through excavation, special attention during construction must be focused on the embankment’s construction, especially of any pipes that are part of the discharge structure that are built through the embankment.
4. To minimize the potential that an embankment will fail, inspection of the structure throughout its construction are needed to assure that components such as anti-seep collars or diaphragms and soil compaction are done properly.
5. All elevations need to be verified in the field as construction occurs to assure that they are consistent with permitted plan specifications.
6. All inlets and outlets shall be stabilized as set forth in the permitted plans to prevent erosion, scour, and sedimentation.

Follow the procedures below to ensure proper construction of the stormwater harvesting components of the system:

- Construct the stormwater harvesting system and the associated irrigation system in accordance with all permitted design specifications and irrigation system design standards.
- Assure that all irrigation components are properly sited and that irrigation spray heads are working properly and not spraying irrigation water onto impervious areas.
- Ensure that all flow meters and recording systems are operational.

5.12.6. Inspections, Operation and Maintenance

Maintenance issues associated with stormwater harvesting systems are related to the proper functioning of the horizontal well or filter system and of the pump and irrigation system. Stormwater harvesting systems must be inspected regularly by the operation and maintenance entity to determine if it is operating as designed and permitted. Reports documenting the results of annual inspections shall be filed with the County every two years.

A. Inspection Items:

- Inspect operation of the stormwater harvesting system to assure that the pump, flow meter, and filter system are operating properly and achieving desired flow volumes.

- Inspect the operation of the stormwater harvesting system to assure proper operational and, with respect to the irrigation system, inspect the pump, timer, distribution lines, and sprinkler heads to assure they are working properly.
- B. Maintenance Activities As-Needed To Prolong Service:
- Repair any components of the stormwater harvesting system which are not functioning properly and restore proper flow and filtration of stormwater.
 - Repair or replace any damaged components of the stormwater harvesting and irrigation system as needed for proper operation.
- C. Record Keeping

The owner/operator of a stormwater harvesting system must keep a maintenance log of activities that is available at any time for inspection or recertification purposes. The log will include records related to the operation of the stormwater harvesting system and the use of the harvested stormwater for irrigation or other approved purposes to demonstrate that the permitted nutrient load reduction is being achieved. A totalizing flow meter to measure the quantity and day/time of pumping and irrigation is required. The maintenance log shall include the following:

- Stormwater volume harvested using a flow meter specifying the day, time, and volume;
- Stormwater volume irrigated or otherwise used using a flow meter specifying the day, time, and volume used;
- Observations of the stormwater harvesting system operation, maintenance, and a list of parts that were replaced;
- Observations of the irrigation system operation, maintenance, and a list of parts that were replaced; and
- Dates on which the stormwater harvesting and irrigation (or other use systems) were inspected and maintenance activities conducted.

5.12.7. Rate-Efficiency-Volume (REV) Curves

The REV curves relate the use rate (R), the yearly discharge volume average efficiency (E), and the runoff storage volume (V) of the pond. The curves reflect several use efficiencies and track the appropriate combinations of use rates and runoff storage volumes to attain the effectiveness. Information concerning any two of these three variables is necessary for the determination of the third.

The REV curves are generalized for application to watersheds of any size and runoff coefficient via the EIA. The units of both the proposed use rate and runoff storage volume are based on the EIA. The proposed use rate is the depth of use multiplied by an area, thus it is a volume term.

An individual REV chart is specific to the five meteorological regions of the State used in this Manual. The designer shall use the REV chart closest to the project site and within the meteorological zone for design. Each REV chart is composed of REV curves and each curve is specific for an average annual effectiveness. The REV chart for Escambia County is shown on Figure 5.12.4.

On every REV chart there is a curve for each of the following efficiency levels (in percentage): 20, 30, 40, 50, 60, 70, 80, and 90. Extrapolation between effectiveness lines for a given runoff storage volume on a linear basis is considered reasonable. The range of the curves is restricted by practical applicability and the limits of the simulation variables. The boundaries of the daily data simulation are such that the use rate is limited to no more than 0.50 inches per day over the EIA and the runoff storage volumes are no less than 0.25 inches and no greater than 6 inches over the EIA. There are marginal returns on efficiencies beyond some maximum runoff storage volume, thus the curves are only produced where there is a marginal change in

effectiveness that is within the measurement accuracy. As an example, at low average annual effectiveness, say 20%, the effectiveness does not change with added runoff storage volume greater than about 2.5 inches.

Figure 5.12.4. REV Curve for Escambia County

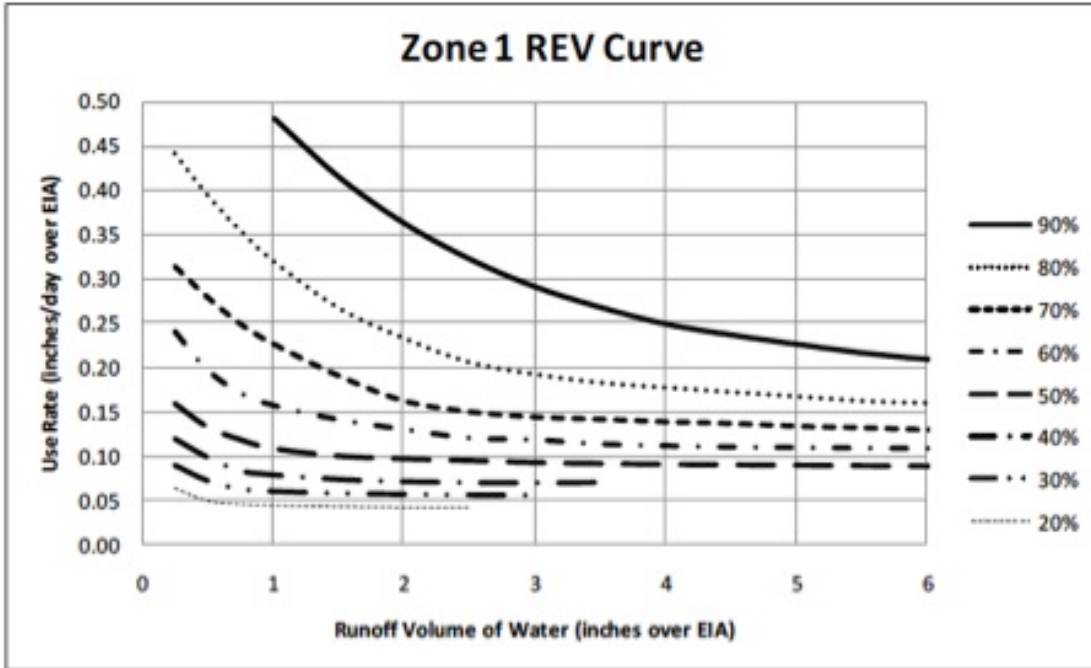

5.12.8. References

7. Design Curves of the Reuse of Stormwater, August 1991. M.P. Wanielista, Y.Yousef, G. Harper, L. Dansereau, College of Engineering, University of Central Florida. Final report submitted to the Florida Department of Environmental Protection. Available online at: <https://stormwater.ucf.edu/research/FILES/Wanielista - design curves for the reuse of stormwater.pdf>

5.13. Up-Flow Filter Systems

5.13.1. Description

Up-flow filters are used in conjunction with detention systems, either wet detention or vault systems, to increase their pollutant load removal effectiveness (Figures 5.13.1). As the name implies, stormwater enters the bottom of these filters and exits from the top. The value of this flow direction is the filter has a lower potential to plug with debris and particulates.

Up-flow filters are very suitable and applicable to ultra-urban development applications because of their capability to remove significant levels of sediments, particulate-bound pollutants (metals, phosphorus and nitrogen) and organics (oil and grease). They are amenable to ultra-urban constraints such as linear configurations and underground installations.

The up-flow filter contains media to remove sediment and both particulate and dissolved pollutants. Using a sorption media in the filter increases the removal of dissolved pollutants. There are two categories for up-flow media filtration defined in this Manual, namely:

- Sand filter systems, and
- Mixed media systems.

A sand up-flow filter is composed of graded sand and is usually two-three feet deep. The sand media removes most particulates of a certain size. Locally available sandy media are preferred but some designs specify the sand particle-size distribution. A summary of early designs and performance is available in a government fact sheet (EPA, 2008). Normally, the sand particle-size distribution is not difficult to achieve. Example areas where sand filters are used, regulated and recommended for use are California (Caltrans, 2004), Austin Texas (2012), Massachusetts (Mass Highway, 2004), and Delaware (www.deldot.gov). Sand filters are not effective in removing nutrients, especially nitrogen.

For mixed media up-flow filters, there are at least two different types of media that when used together achieve specified pollutant removal effectiveness. Media mixtures that are effective for removing a wide range of pollutant types are sand/clay with other additions (Woelkers et al., 2006), and expanded clay with other media (Ryan et al., 2009, Hardin et al., 2012). Some mixes target specific pollutants, such as used by the Washington State DOT whose mix targets dissolved metals (WSDOT, 2008), and media mixes that target phosphorus (Ma et al., 2009), nitrate (Kim et al., 2003), phosphorus and nitrogen (O’Reilly et al., 2012), organics (Milesi et al., 2006), and metals and dioxins (Pitt and Clark, 2010). Thus, a wide selection of media mixtures can be used for media filtration systems (Chang et al., 2010).

Most mixed media can treat stormwater, wastewater, groundwater, landfill leachate, and sources of drinking water for nutrient removal via physicochemical and microbiological processes (Chang et al., 2010). The media may include, but are not limited to, compost, clay, zeolite, wheat straw, newspaper, sand, limestone, expanded clay, wood chips, wood fibers, mulch, pumice, bentonite, tire crumb, expanded shale, oyster shell, coconut coir, and soy meal hull (Wanielista and Chang, 2008). This document, entitled Alternative Stormwater Sorption Media for the Control of Nutrients, was prepared for the SWFWMD and is available online at:

<http://stormwater.ucf.edu/wp-content/uploads/2014/09/AlternativeMedia2008.pdf>

UP-FLOW FILTER SYSTEM SUMMARY

Advantages/Benefits	Used to increase the treatment effectiveness of wet detention systems; applicable to ultra-urban developments and constraints such as linear configurations or underground installations.
Disadvantages/Limitations	Requires a flow meter and filtration system; filter system needs

	regular inspection and maintenance to avoid clogging and ensure continued operation.
Volume Reduction Potential	Low
Pollutant Removal Potential	Moderate for all pollutants
Key design considerations	Use at the discharge end of a detention system; must have flow diverter for high flows to bypass system; typical filtration rate of 20"/hr; filtration media mixes available for different pollutants; at least 30" deep filter system; must have bottom wet with anoxic conditions to remove nitrogen; replacement of filter media on regular basis needed for phosphorus removal.

5.13.2. Treatment required

The required nutrient load reduction will be determined by the applicable Performance Standard in [Section 4.3](#), or by the NFWFMD ERP requirements. The Up-Flow Filter will be used as part of a BMP Treatment Train with a wet detention system.

Figure 5.13.1a. Off-line Up-Flow Filter Schematic

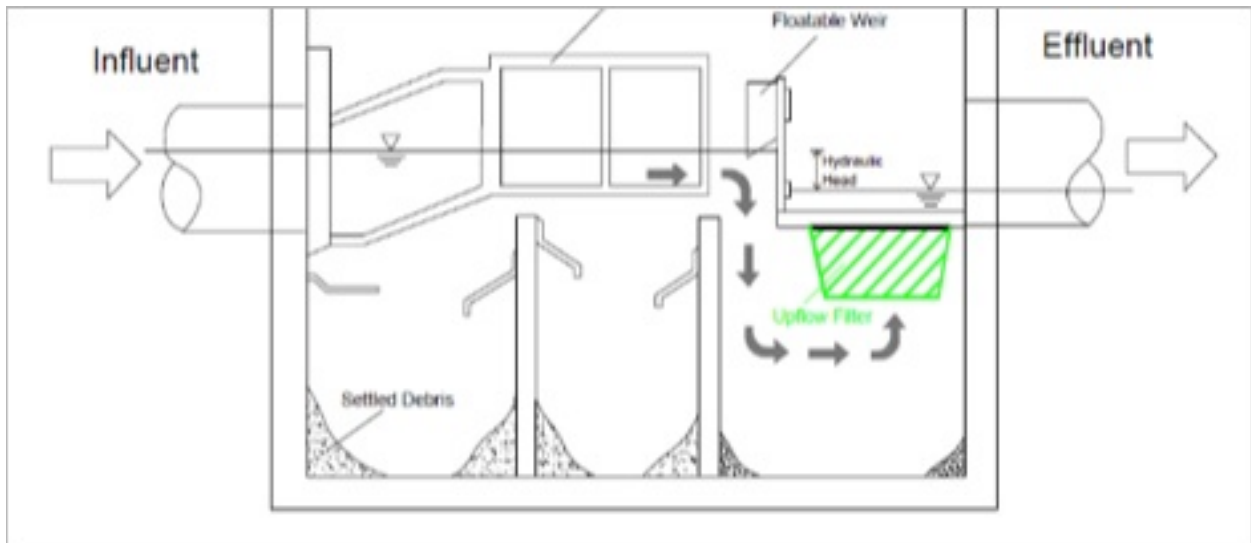
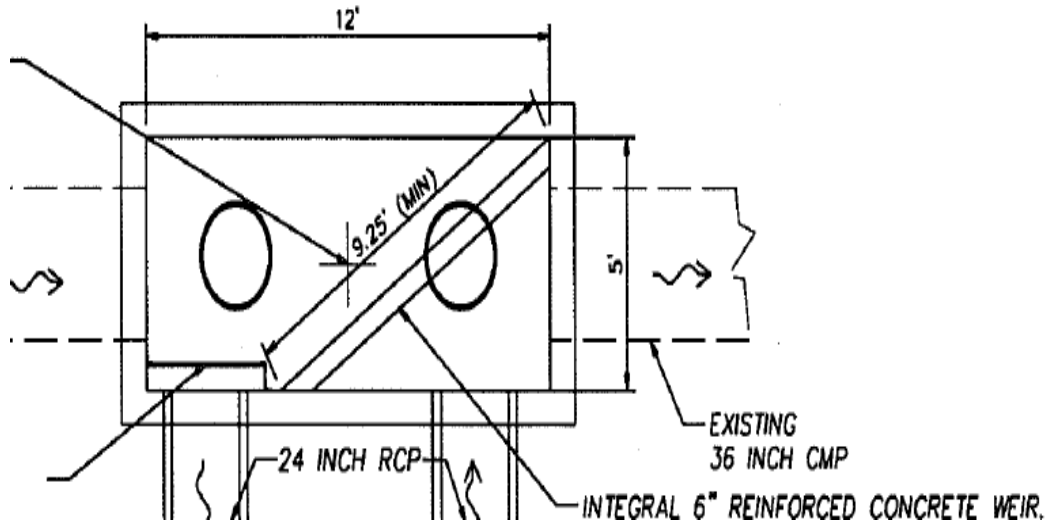

Figure 5.13.1b. Top View of Diversion Box to Off-Line Filter



5.13.3. Expected Load Reduction

The expected pollutant load reduction from an Up-Flow Filter System is dependent on the volume of water directed through the filter and the media within the filter. The design engineer must specify each design parameter and the treatment effectiveness can be determined using the BMPTRAINS program.

The volume of water is expressed as inches captured over the watershed. The inches captured is used to determine the average annual removal capture volume for the meteorological zone in which the project is located as well as the watershed runoff characteristics. Select the treatment volume and then use [Table A2-1](#) to determine the annual percentage of stormwater that is captured.

However, unlike retention systems that provide full pollutant load reduction for the treatment volume being infiltrated, filter media only remove a fraction of the nitrogen and phosphorus. The fraction on nutrients removed is showed for five most frequently used media in Table 5.13.1.



When the up-flow filter is bypassed, the stormwater treatment is equal to the effectiveness of the vault or the wet detention pond. When stormwater flows through the up-flow filter the removal is calculated considering a treatment train approach. Removal is the sum of the first treatment (vault or wet detention pond) plus the removal from the filter. The up-flow filter percent load reduction of Table 5.13.1 is applied to the nutrient concentrations remaining after the vault or wet pond effectiveness.

To illustrate the value of the Up-Flow Filter System media for increasing TN and TP removal, consider the following example. A wet detention system is designed for an average annual residence time of 21 days. The effectiveness of the wet pond for TN removal is 36.2% and TP is 61.5% (see [Figures 5.1](#) and [5.2](#)). Adding an up-flow filter with B&G DOT filter media provides 45% removal of TN and TP during filter operation (Table 5.13.1). If 1.5 inches of the water in the wet detention pond (treatment volume in this case) is directed through the up-flow filter, then the annual TN and TP treatment effectiveness of the B&G DOT filter and the wet pond is increased to 50% and 74% respectively. If a slower rate of filtration is used with B&G CTS media, the annual TN effectiveness increases to 70% and annual average TP removal increases to 90% (see BMPTAINS for calculations).

5.13.4. Design Criteria





1. Use of the Up-Flow Filter system after wet detention or after a vault at the end of pipe, must include a provision to bypass stormwater when the flow is in excess of the treatment rate. The treatment rate is expressed as inches over the watershed. The percentage of bypass is used to calculate the annual effectiveness.
2. Use a diversion structure to direct the treatment volume into the Up-Flow Filter and to bypass higher flows into a downstream conveyance system.
3. The design rate of filtration for up-flow filters is greater than or equal to 20 inches/hour because of cost and space constraints. Slower rates can be used especially if effectiveness increases. Table 5.13.1 shows the filtration rates in common use and those necessary to achieve the desired effectiveness when using the media in the table. Additional details for design rates are found in Wanielista, et. al. (2014) that is online at: http://www.dot.state.fl.us/research-center/Completed_Proj/Summary_RD/FDOT-BDK78-977-19-rpt.pdf. Also when using the BMPTRAINS model, user defined filter media data may be entered into the program.
4. The depth of an up-flow filter is at least 30 inches. This depth typically allows for the residence time necessary to remove nutrients. For nitrogen removal, the up-flow filter must remain wet. A wet condition is not necessary if phosphorus removal is only needed.
5. For phosphorus removal using the media of Table 5.13.1, the design rate of ortho-phosphate (OP) removal is 0.25 mg of OP/gram of media. This rate is used to determine the replacement or maintenance time for the filter. Typically, maintenance or replacement times are set at greater than 2 years. Even though particulate matter is removed by the Up-Flow Filter most of the particulate matter is removed by sedimentation in the pre-treatment area of a vault or within the wet detention pond.

A typical schematic of an Up-Flow Filter system used at the discharge of a wet detention system or detention vault are shown in Figures 5.13.1 and 5.13.2. Table 5.13.1 lists five of the more commonly used filter media. The table indicates whether a media filter system is used

upstream (as the first BMP) or downstream following a BMP. The notation  indicates the media is used upstream while the notation  indicates the media is used downstream. Some media mixes can only be used as a first BMP and others are used after wet detention or retention basins. The user must be careful to pick the correct blend depending on the location.

The B&G OTE up-flow filter media is used after storage in a vault at the end of a pipe. The effectiveness assumes that there is an annual residence time of at least 10 minutes and a screening for debris before the up-flow filter. The B&G OTE and the B&G CT up-flow filter media are used after a wet detention pond designed for an annual residence time of at least 21 days. The Austin Sand Filter (SAT) and the Marion County Florida retention media (B&G CTS) also are shown in Table 5.13.1. The Marion County media has been used for infiltration BMPs where there is a need to protect ground water from nutrients that may infiltrate into the ground water. Alachua County is considering a similar requirement to reduce nitrate movement into the ground water in Sensitive Karst Areas and springsheds.

Table 5.13.1. Filter Media and Removal Effectiveness.

DESCRIPTION OF MEDIA	V 7.8	PROJECTED TREATMENT PERFORMANCE *			TYPICAL LIMITING FILTRATION RATE (in/hr)
		TSS REMOVAL EFFICIENCY	TN REMOVAL EFFICIENCY	TP REMOVAL** EFFICIENCY	
 <p>B&G ECT^{(1)(A)} A first BMP, ex. Up-Flow Filter in Baffle box and a constructed wetland⁹ (USER DEFINED BMP)</p>					
 <p>B&G OTE^{(1)(A)(B)} Up-flow Filter at Wet Pond & Dry Basin Outflow (FILTRATION)</p>					
 <p>B&G ECT3^{(1)(C)} Inter-event flow using Up-flow Filter at Wet Pond Outflow & Down-flow Filter at Dry Basin (FILTRATION)</p>					
 <p>SAT^{(1)(D)} A first BMP, as a Down-flow Filter (FILTRATION)</p>					
 <p>B&G CTS^{(1)(E)(F)} Down-Flow Filters 12" depth*** at wet pond or dry basin pervious pave, tree well, rain garden, swale, and strips</p>					
	Expanded Clay ² Tire Chips ¹	70%	55%	65%	96 in/hr
	Organics ⁶ Tire Chips ¹ Expanded Clay ⁴	60%	45%	60%	96 in/hr
	Expanded Clay ⁴ Tire Chip ¹	60%	45%	60%	96 in/hr
	Sand ³	85%	30%	60%	1.75 in/hr
	Clay ⁴ Tire Crumb ⁵ Sand ⁷ & Topsoil ⁹	90%	60%	90%	0.25 in/hr

NOTES ¹No generally accepted BMP at this time. Also can be used as a downstream BMP but the removal must be lowered.
²All Effectiveness Estimates to nearest 5%; ³Phosphorus removal has limited life expectancy; ⁴24" depth has TN and TP removals of 75 & 95%
 acronyms B&G - BOLD & GOLD; SAT - Sand Austin Tx; ECT- Expanded Clay and Tire; ECT3 Expanded Clay and Tire in Treatment Train
¹ Tire Chip 3/8" and no measurable metal content (approximate dry density = 730 lbs/CY)
² Expanded Clay 5/8 and 3/8 blend (approximate dry density = 950 lbs/CY)
³ Sand ASTM C-33 with no more than 3% passing # 200 sieve (approximate dry density = 2200 lbs/CY)
⁴ Expanded Clay 3/8 in blend (approximate density = 950 lbs/CY)
⁵ Tire Crumb 1-5 mm and no measurable metal content (approximate density = 730 lbs/CY)
⁶ Medium Plasticity typically light colored Clay (approximate density = 2500 lbs/CY)
⁷ Sand with less than 5% passing #200 sieve (approximate density = 2200 lbs/CY)
⁸ Organic Compost (approximate density of 700 lbs/CY) Class 1A Compost or Mix of yard waste
⁹ Local top soil is used over CTS media in dry basins, gardens, swales and strips, is free of roots & debris but is not used in other BMPs.

A - Demonstration Bio Media for Ultra-urban Stormwater Treatment, Wanielista, et.al. FDOT Project BDK78 977-19, 2014
 B - Nutrient Reduction in a Stormwater Pond Discharge in Florida, Ryan, et al, Water Air Soil Pollution, 2010
 C - Up-Flow Filtration for Wet Detention Ponds, Wanielista and Flint, Florida Stormwater Association, June 12, 2014.
 D - City of Austin Environmental Criteria Manual, Section 1.6.5, Texas, 2012
 E - Nitrogen Transport and Transformation in Retention Basins, Marion Co, Fl, Wanielista, et al, State DEP, 2011
 F - Improving Nitrogen Efficiencies in Dry Ponds, Williams and Wanielista, Florida Stormwater Association, June 18 2015

5.13.5. Construction considerations

Typical components of an Up-Flow Filter system are the detention system, collection and filtration structures, pretreatment areas to remove gross solids, the media filtration bed itself, effluent collection systems and discharge structures to downstream conveyances or surface water outfalls.

There is no special construction equipment needed other than that commonly used for setting stormwater pipes and excavation. As for any stormwater system, elevation control is needed to establish both the inlet and outlet invert elevations.

Since Up-Flow Filters typically are used in conjunction with wet detention basins or vaults, the first step in constructing an up-flow filter is to construct the wet detention basin or vault in compliance with all permitted design specifications. To assure proper construction of the up-flow filter the following construction procedures are required:

- Construct the wet detention basins or vaults following the requirements in this section and Section 8.0 of the NFWFMS [Applicant’s Handbook Volume 2](#).
- Construct the up-flow filter in accordance with all permitted design specifications and the design criteria of this Manual.

A typical schematic of an Up-Flow Filter used at the discharge end of wet detention pond is shown in Figure 5.13.2. A typical schematic of an Up-Flow Filter used at the discharge end of a detention vault is shown in Figure 5.13.1

Figure 5.13.2. Typical Schematic of an Up-flow Filter after Wet Detention with Water Flow Direction Shown

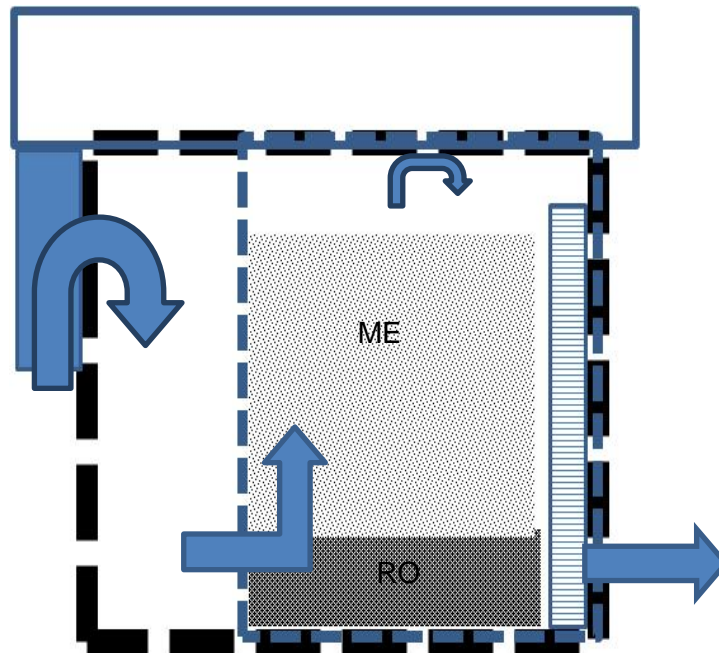

5.13.6. Inspections, Operation and Maintenance

Maintenance issues associated with up-flow media filters are less than with down-flow filters. A pump suction-type evacuator is usually used to remove debris. The same equipment cleans debris and solids from catch basins and sewer lines. In front of a filter, a settling system minimizes solids and debris on the filter. The sedimentation process of the settling system removes heavy solids, debris and floating materials, and reduces the maintenance needed to keep the filter operational. Reports documenting the results of annual inspections shall be filed with the County every two years.

A. Inspection Items:

- Inspect operation of the up-flow filter to assure that water is flowing though the filter.
- Inspect the inlet and outlet structures to assure they are working properly and no debris impedes operation.

- B. Maintenance Activities As-Needed To Prolong Service:
- Repair any components that are not functioning properly and restore proper flow and filtration of stormwater.
 - Repair or replace any damaged components as needed for proper operation.
- C. Record Keeping
- The owner/operator of an Up-Flow Filter must keep a maintenance log of activities which is available at any time for inspection or recertification purposes. The log will include records related to the operation and maintenance. The maintenance log shall include the following:
- An estimate of the stormwater volume passing through the filter in a year;
 - Inspection dates and forms
 - Maintenance dates and activities including a list of parts that were replaced;

5.13.7. References

1. Austin Texas (2012). [City of Austin Texas Environmental Criteria Manual](#). Section 1.6, Austin.
2. Caltrans (2006). Highway 267 Filter Fabric Sand Trap Pilot Study, 2004–2005 Interim Report, California Department of Transportation, CTSW-RT-05-157.01.1.
3. Chang, N., F. Hossain, M. Wanielista (2010). [Filter Media for Nutrient Removal in Natural Systems and Built Environments: Previous Trends and Perspectives](#). Environmental Engineering Sciences, Volume 27, Number 9, pp 689-706.
4. EPA, Environmental Protection Agency (2008). [Stormwater Technology Fact Sheet: Sand Filters](#). Washington D.C. EPA 832-F-99-007, September.
5. Hardin, M., M. Wanielista, and M. Chopra (2012). [A Mass Balance Model for Designing Green Roof Systems that Incorporate a Cistern for Re-Use](#). Water, 4, 1, doi: 10.3390/w40.
6. Kim, H. H., E. A. Seagren, and A. P. Davis (2003). [Engineered Bioretention for Removal of Nitrate from Stormwater Runoff](#), Water Environment Research, 75 (4): 355–367.
7. Ma, J., K. Tracy, and J. Lenhart (2009). Phosphorus Removal in Urban Runoff Using Adsorptive Filtration Media, Proceedings of Storm-Con 2009, August 16–20, Anaheim, CA.
8. MassHighway (2004). [Storm Water Handbook for Highways and Bridges, Massachusetts Highway Department](#).
9. Milesi, C., S. A. de Ridder, D. DeLeon, H. Wachter (2006). A Comparison of Two Media Filtration BMP Treatments for the Removal of PAHs and Phthalates from Roadway Runoff, Proceedings of StormCon 2006. July 24–27, Denver, CO.
10. O'Reilly, A., M. Wanielista, N. Chang, Z. Xuan, and W. Harris (2012). [Nutrient removal using biosorption activated media: Preliminary biogeochemical assessment of an innovative stormwater infiltration basin](#). Journal: Science of the Total Environment. May.
11. Pitt, R. and S. Clark (2010). [Evaluation of Biofiltration Media for Engineered Natural Treatment Systems](#), Department of Civil, Construction and Environmental Engineering, University of Alabama.
12. Ryan, P., M. Wanielista and N. Chang (2009). [Nutrient Reduction in Stormwater Pond Discharge Using a Chamber Up-flow Filter and Skimmer \(CUFS\)](#), Water, Air and Soil Pollution, doi:10.1007/s11270-009-0174-x, Aug.
13. Wanielista, Martin and Ni-Bin Chang (2008). [Alternative Stormwater Sorption Media for the Control of Nutrients, Final Report: Project #B236](#), Southwest Florida Water Management District, Brooksville, FL.
14. Wanielista, Martin, Ni-Bin Chang, Andrew Randall, Manoj Chopra, Mike Hardin, Jamie Jones, Andrew Hood, and Sultan Salamah (2014). [Demonstration Bio Media for Ultra-urban Stormwater Treatment](#), Florida Department of Transportation, Tallahassee, FL.

15. Williams, Shane and Martin Wanielista (2015). Improved Nitrogen Efficiencies in Dry Ponds, Florida Stormwater Association Annual Meeting, June 18.
16. WSDOT (2008). [Washington State Department of Transportation Highway Runoff Manual, M 31-16.01](#), Environmental and Engineering Programs Design Office.

5.14. Managed Aquatic Plant System (MAPS) Design Criteria

5.14.1. Description

Managed Aquatic Plant Systems (MAPS) are aquatic plant-based BMPs that remove nutrients through a variety of processes related to nutrient uptake, transformation, and microbial activities. Examples of MAPS include planted littoral zones and floating wetland mats. In the latter example, harvesting of the biomass is an essential process of the BMP.

Generally, wet detention systems by themselves can't achieve the required levels of nutrient removal from stormwater. In nearly all cases, a BMP treatment train will be required when using a wet detention system. Sometimes components of the BMP treatment train include source controls or pretreatment BMPs such as Florida-friendly landscaping or swales to reduce either the stormwater nutrient concentrations or volume discharged into the wet detention system. However, in many areas, high water tables and slowly percolating soils do not make infiltration practices practical or effective. MAPS can be incorporated into a wet detention BMP treatment train to provide additional treatment and nutrient removal after the wet pond has provided reduction of pollutants through settling and other mechanisms that occur within the wet pond.

MANAGED AQUATIC PLANT SYSTEM SUMMARY

Advantages/Benefits	Increases the treatment effectiveness of wet detention systems, especially for nutrients; increases the aesthetics and habitat quality of wet detention systems.
Disadvantages/Limitations	Increases maintenance requirements of wet detention systems; water level fluctuation in wet detention systems often reduces growth of littoral zone plants.
Volume Reduction Potential	None
Pollutant Removal Potential	Low for all pollutants
Key design considerations	Determine if littoral zone or floating wetland mats will be used; for littoral zones ensure proper slopes and surface water elevations; also determine plant species and planting densities to achieve the required areal extent and plant coverage; for floating wetland mats, determine plant species and preferred location for mats; also determine if exclusion netting is needed to protect plants from herbivores.
Key construction and maintenance considerations	Inspect to ensure plant survival and coverage meet permit requirements and replant as needed; identify nuisance or exotic plants and remove; harvest and replace plants in floating mats on an annual basis.

5.14.2. Nutrient Removal Effectiveness and Credits

The stormwater treatment nutrient removal effectiveness and credits for the different types of MAPS shall be based on data obtained from monitoring of these systems in Florida. The nutrient removal credits associated with MAPS shall be calculated using the BMPTRAINS software or the underlying BMP Treatment Train Equations. Table 5.14.1 summarizes the nutrient reduction credits based on the data that is currently available. It is anticipated that more data will become available allowing re-evaluation of the credits in the future.

Table 5.14.1. Nutrient Removal Credits for MAPS

Type of MAPS	TN Removal	TP Removal
Littoral zone	10%	10%
Floating Wetland Mats or Islands	10%	10%

The applicant must provide independent scientific data based on Florida field monitoring to validate the nutrient load reduction of any MAPS proposed for use.

5.14.3. Littoral Zone Design Criteria

Section 8.6 of the NFWFMD [Applicant’s Handbook Volume II](#) lists their requirements for littoral zones. Littoral zones are an optional component of wet detention systems if additional treatment volume and pretreatment BMPs are used. The littoral zone is that portion of a wet detention pond that is designed to contain rooted aquatic plants. Extending and gently sloping the sides of the wet detention system to a maximum depth of four feet below the normal water level or control elevation usually creates the littoral area. One of the difficulties of successful littoral zone establishment and maintenance is the frequent changes in water level elevations within a wet detention pond. Additionally, experience has shown that long-term survival of littoral zones is best when they are not located adjacent to private lots. Consequently, littoral zones typically are located near the outfall of a wet detention pond or along areas with common ownership. Littoral zones should also be considered in other areas of the pond that have depths suitable for successful plant growth such as a shallow shelf between the inflow sumps and the rest of the pond or on a shallow shelf in the middle of the pond, provided maintenance can be undertaken. If treatment credit is proposed for littoral zones placed adjacent to private lots, the applicant shall provide additional assurances through their legal operation and maintenance documents or through an easement that the littoral zone will be maintained as permitted.

The littoral zone is established with native plants by planting and/or the placement of wetland soils containing seeds of native plants. A specific vegetation establishment plan must be prepared for the littoral zone. The plan must consider the water elevation fluctuations of the wet detention pond and the ability of specific plants to be established. A list of recommended native plant species suitable for littoral zone planting is included in Table 5.15.2. In addition, a layer of muck soil can be incorporated into the littoral area to promote the establishment of the wetland vegetation. When placing muck, special precautions must be taken to prevent erosion and turbidity problems in the pond and at its discharge point while vegetation is becoming established in the littoral zone.

The design criteria for wet detention littoral zones are:

1. The littoral zone shall be gently sloped (6H:1V or flatter). At least 30 percent of the wet detention pond surface area shall consist of a littoral zone. The percentage of littoral zone is based on the ratio of vegetated littoral zone to surface area of the pond at the control elevation.
2. The bleed down volume should not cause the pond level to rise more than 18 inches above the control elevation unless the applicant affirmatively demonstrates that the littoral zone vegetation can survive at greater depths.
3. Within 24 months of completion of the system, 80 percent coverage of the littoral zone area by suitable aquatic plants is required with no more than 10% consisting of exotic or nuisance species such as cattails or primrose willow.
4. Planting of the littoral zone is required to meet the 80% coverage requirement. As an alternative to planting, portions of the littoral zone may be established by placement of

wetland top soils (at least a four inch depth) containing a seed source of desirable native plants. When using this alternative, the littoral zone must be stabilized by mulching or other means. At least the portion of the littoral zone within 25 feet of the inlet and outlet structures must be planted. In addition, monitoring of plants shall be done quarterly to ensure that the 80% coverage requirement is met within one year.

5. In parts of Florida, the Channeled Apple Snail has been shown to decimate littoral zone vegetation so designers need to be aware of this problem and will be required to provide additional assurances that damage done to the vegetation will be repaired within one month.
6. Replanting shall be required if the percentage of vegetative cover falls below the permitted level. The native vegetation within the littoral zone shall be maintained as part of the system's operation and maintenance plan. Undesirable species such as cattail and other exotic or nuisance plants shall be controlled and removed as needed.
7. An operation, maintenance, and management plan that specifies the schedule for inspections and the maintenance and management activities that will be done shall be provided.

Table 5.14.2. Native Plant Species Suitable for Littoral Zone Plantings or Adjacent to Wet Detention Ponds

SCIENTIFIC NAME	COMMON NAME	PLANTING ZONE *	FEATURES
FRESHWATER WOODY SPECIES (trees, shrubs, and palms)			
Acer rubrum	Red maple	1-2	Medium sized tree specimen known for its attractive brilliant red fall color
Carpinus caroliniana	American hornbeam "Blue Beech"	1	Medium sized tree with attractive bark, and interesting form.
Carya aquatica	Water hickory	1-2	Large tree with large leaves. Fall color (bright yellow)
Cephalanthus occidentalis	Buttonbush	1-2	Large shrub up to 10 ft tall with white flowers resembling buttons. Buttonbush has a scrubby appearance owing to the dying of leader shoots leaving dead stumps.
Clethra alnifolia	Sweet pepper bush	2	Highlighter, shrub with attractive berries
Crataegus marshallii	parsley hawthorn	1	showy, white flowers and red fruits are good wildlife food
Fraxinus caroliniana	Popash	1-2	Large specimen with attractive foliage and deep furrowed bark
Gordonia lasianthus	Loblolly bay	1-2	Medium to large tree. Large white flowers and attractive foliage
Hypericum spp.	St. Johns Wort	2	Highlighter, shrub
Ilex cassine	Dahoon holly	1	Small tree or shrub with prominent red berries and attractive evergreen foliage
Ilex vomitoria	Yaupon	1	General landscape shrub with attractive red berries.
Liquidambar styraciflua	Sweetgum	1-2	Medium to large specimen. Attractive unusual shaped foliage and

SCIENTIFIC NAME	COMMON NAME	PLANTING ZONE *	FEATURES
			good fall color. Not tolerant of long term inundation
Magnolia virginiana	Sweet bay	1	Medium sized tree with attractive foliage and white flowers.
Myrica cerifera	Wax myrtle	1	Large shrub with attractive aromatic evergreen foliage. Bluish green berries in autumn and winter are eaten by many birds. Often used in groups for general landscaping and high lighting or accent around ponds.
Nyssa biflora	Blackgum tupelo	1-2	Glossy foliage turning bright red in autumn. Fruit matures in the fall; is consumed by many birds. Flowers are a source for honey.
Persea palustris	Swamp redbay	1-2	Attractive aromatic glossy green foliage. Bitter fruit is eaten by wildlife. Does not do well in submerged locations.
Quercus michauxii	Swamp oak	1	Large rapid growing tree with attractive nearly evergreen foliage. Acorns eaten by wildlife.
Quercus phellos	Willow oak	1	Large deciduous tree with willow-like leaves. Acorns provide food for wildlife.
Rhapidophyllum hystrix	Needle palm	1	Small to medium sized palm with attractive foliage used for providing tropical highlights. Sharp needles along the trunk lead to its name
Sabal palmetto	Cabbage palm	1	Large palm suited to all areas. Attractive tropical fan shaped foliage.
Taxodium spp.	Bald or Pond Cypress	1-2	Large aquatic deciduous conifer of picturesque form. Preliminary observation shows good survival and rapid growth of either species when used for stormwater enhancement purposes.
<u>FRESHWATER HERBACEOUS SPECIES (herbs, sedges, grasses, and ferns)</u>			
Bacopa caroliniana	Lemon bacopa "Water hyssops"	2	Crushed leaves and stems lemon scented. Flowers blue.
Canna flaccida	Golden canna "Canna lily"	2	Very good highlighter. Used on fringe of ponds and lakes. Large showy yellow flowers.
Cladium jamaicense	Saw-grass	1-2	Coarse perennial sedge up to 10 ft. tall. Grows equally well in water or several feet above water level. Long narrow and serrated leaf blades.

SCIENTIFIC NAME	COMMON NAME	PLANTING ZONE *	FEATURES
			Provides nesting, protection and food (seeds) for water fowl and other birds.
Coreopsis leavenworthii	Tickseed	2	Perennial herb w/ attractive yellow flowers. Prefers soil at edge of ponds or lakes
Crinum americanum	Swamp lily	2	Good highlighter at pond fringes. Showy white fragrant flowers. Stems usually less than waist high.
Cyperus odoratus	Umbrella sedge	1-2	Good accent plant usually grown in clumps on edge of ponds. Does well in areas of fluctuating water but also in more upland areas. Its stems are usually less than 3 ft. tall with a conspicuous umbrella shaped foliage and brown seed head
Diodia virginiana	Buttonweed	1-2	Does well in wet soils along the border of ponds. Relatively low growing perennial herb. Small white flowers between leaves and stem. Does not prefer submerged conditions.
Dryopteris ludoviciana	Southern shield Leatherleaf fern	1-2	Suited to wet soils in the zone of fluctuation above the permanent pool
Echinochloa crusgalli	Barnyard grass "wild millet"	1-2	Best suited for edges of ponds and lakes. Steps up to 4 ft tall. Seeds used by waterfowl and songbirds
Eleocharis spp.	Spikerushes	1-2	Suitable for establishing marshes along the coast. Slender, dwarf, and water spikerushes may be submerged. Other varieties grow along the landward edge of ponds. May be grown in clumps or as colonies depending on species
Eriocaulon decangulare	Hat pins	2	Low growing plant with slender spikes. Top is tipped with a small white "button". Provides good contrast with wetland grasses or sedges
Hibiscus spp.	Marsh hibiscus	1-2	Normally used for accent on the edge of ponds. Large flowers 4-8" in diameter.
Hydrocotyle umbellata	Water pennywort	2	Numerous round partly to deeply lobed leaves centrally attached to a stem up to 12 inches long. Grows well on the surface of the water or as a ground cover rooted along the edge of ponds
Hymenocallis spp.	Spider lilies	1-2	Provides good ground cover, used for accent on the edge of ponds. Showy white flowers. Best on wet soils.

SCIENTIFIC NAME	COMMON NAME	PLANTING ZONE *	FEATURES
<i>Iris virginica</i>	Anglepod blue flag iris	2	Prefers wet soils at the fringes of lakes and ponds. Average height of 1 ft. With blue flowers. Used for highlighting, planted in groups at the edges of wetlands or ponds.
<i>Iris irginicus</i>	Southern blue flag iris	2	Prefers habitats similar to “angelpod”. More upright grower. Flowers last for several weeks in spring
<i>Juncus effusus</i>	Soft rush	2	Very attractive with pale green hollow stems up to 4 ft tall. Commonly used in large clumps along the edge of lakes or ponds. Seeds used by waterfowl. Does not die back in winter making it a good plant for wet detention ponds where it is planted in clumps
<i>Nelumbo lutea</i>	American lotus	3-4	Attractive, large leafed rooted aquatic. Circular leaves up to 24 inches across with large showy yellow flowers. Planted along the outside of littoral zones in groups spaced about 25 feet apart
<i>Nuphar luteum</i>	Spatterdock	3-4	Water lily with large oval or heart shaped leaves up to 16 inches long and 10 inches wide. Small, spherically shaped yellow flowers. Roots provide good habitat for shellcrackers.
<i>Nymphaea mexicana</i>	Yellow water lily	3-4	Similar in form and use as other water lilies. Bright yellow flowers.
<i>Nymphoides aquatica</i>	Floating hearts	2-4	Similar to other water lilies. Short thick roots with a cluster of small white flowers
<i>Osmunda cinnamomea</i>	Cinnamon fern	2	Attractive lush foliage best suited for shaded areas internal to or approaching the periphery of cypress or other wooded wetlands
<i>Osmunda regalis</i>	Royal fern	2	Similar habitat as cinnamon fern. May be used to add a “rain forest” like appearance.
<i>Panicum hemitomon</i>	Maidencane	1-2	A grass that does well in dry soils or submerged in water. Forms dense colonies in wet areas and shallow parts of ponds. Aggressive grower.
<i>Peltandra virginica</i>	Green Arrow arum		Perennial herb with arrow shaped leaves up to waist high. Blades vary in size up to a foot wide and 1.5 feet long
<i>Polygonum spp.</i>	Smartweed	2	An annual or perennial herb with creeping stems that grows along the

SCIENTIFIC NAME	COMMON NAME	PLANTING ZONE *	FEATURES
			ground. Stems have spikes of small pink and white flowers. Seeds used by birds, waterfowl, and small mammals
Pontedaria cordata	Pickerelweed	3	One of the most commonly used and attractive plants in littoral zones. Attractive dark green lance shaped leaves with violet blue flowers.
Sagittaria lancifolia	Arrowhead	3	Another of the more common plants used in littoral zones. Has narrow elliptical lance shaped leaves up to 2 ft in length and 4 inches wide with small white flowers
Sagittaria latifolia	Broadleaf arrowhead	3	Has deeply lobed and arrow shaped leaves up to 1 foot long with small white flowers
Scirpus californicus	Giant bulrush	2-3	Has blunt triangular stems up to 10 ft tall.
Scirpus validus	Soft stem bulrush	2-3	Has cylindrical stems up to 8 feet tall. Attractive brown spikelets with seeds that are eaten by waterfowl and songbirds
Spartina bakeri	Sand cordgrass	1-2	This grass grows in stout and dense clumps. Excellent accent plant on fringes of wet ponds. Has a reddish tinge when flowering.
<p>* Planting Zones:</p> <p>1) + 0.5 feet or higher than the normal level of the permanent pool.</p> <p>2) +0.5 feet above to -1.0 feet below normal pool.</p> <p>3) - 1.0 feet to - 3.0 feet below the control elevation of the permanent pool.</p> <p>4) - 3.0 feet to - 5.0 feet below normal water level.</p>			

5.14.4. Floating Wetland Islands or Mats

Because plants in the aquatic environment store and concentrate nutrients in their tissues, created wetlands have been used extensively for bioremediation. Most of the treatment of nutrient rich water within a wetland occurs in the thin aerobic layer at the surface of the soils within plant communities. This aerobic biofilm is a result of oxygen leakage from the plant roots at the soil-water interface. Floating wetland mats or islands allow growth of plants that have the ability to extract and store nutrients from surface waters. Through the periodic removal of mature macrophytes from the floating wetland island or mat, accumulated nutrients are prevented from re-entering the aquatic ecosystem at senescence.

Floating Wetland Design Criteria:

1. The area of floating wetland mats shall be at least five percent (5%) of the surface area of the wet detention pond.

2. The floating wetland island or mats shall use a variety of plants that have been documented to have high nutrient uptake in their plant tissues. Some proven plants include *Canna flaccida*, *Juncus effuses*, *Spartina spp.*, *Pontederia cordata*,
3. Floating wetland mats or islands shall be installed and maintained in accordance with permitted design specifications and the manufacturer's instructions.
4. Where necessary, exclusion netting shall be used on floating islands or mats to prevent turtles, grass carp, or other animals from eating the plant roots or plants such that they adversely affect the successful growth of the aquatic plants. The applicant may propose alternative mechanisms to minimize eating of plant roots or plants based on an affirmative demonstration, based on manufacturer's recommendations, plans, test results, calculations or other information, that the alternative design is appropriate for the specific site conditions and will meet the above considerations.
5. Within 6 months of installation, the floating wetland island or mat shall have at least 90 percent coverage with no more than 10% consisting of exotic or nuisance species.
6. An operation, maintenance, and management plan that specifies the schedule for inspections and the maintenance and management activities that will be done shall be provided. Plants on the mats or islands shall be removed and replaced at a minimum on an annual basis. The harvested plant and potting materials shall be removed and disposed of in such a manner that nutrients will not re-enter the stormwater treatment system.

5.15. Biofiltration Systems with Biosorption Activated Media (BAM)

5.15.1. Description

Biofilters or biofiltration systems are a suite of typically offline BMPs that use engineered media, such as [Biosorption Activated Media \(BAM\)](#), to enhance nutrient removal when native soils can't provide adequate pollutant removal or infiltration. They also are used in Sensitive Karst Areas to minimize nitrates where the sandy soils, high infiltration rates, low soil moisture, and aerobic conditions transform nitrogen into nitrate which moves into the ground water. Biofiltration BMPs can serve both small and large watersheds. The large watersheds typically discharge into retention basins or wet detention systems. The wet detention systems will then use up-flow filters on the discharge to further remove nutrients. Small drainage areas discharge into retention areas or rain gardens that have BAM within them to limit nitrates. Typically, these are either offline retention BMPs or online stormwater detention BMPs that serve small drainage areas of up to two acres.

Biofiltration systems with BAM incorporate select soils, cellulose, or other pollutant removal mixtures. For the removal of phosphorus, BAM has to have a sorption capacity for phosphorus. For nitrate removal, other components of the biofiltration system must include an anoxic zone. Planted vegetation to facilitate treatment for removal of nutrients is common. The use of BAM will also reduce toxic compounds in the discharge waters.

There are many opportunities for biofiltration systems and many configurations making them highly applicable for on-site treatment in urban development, especially in areas undergoing redevelopment. **They can have an underdrain for surface water discharge but also can be designed to function as retention systems.** Examples include:

- Rain gardens (bioretention areas)
- Landscape planter boxes
- Tree box filters

The latter two types of biofiltration systems are discussed in more depth in [Section 5.15.8](#) and [5.15.9](#).

The biofiltration system may be lined to keep it separate from the surrounding water table and to maintain an anoxic zone in the bottom of the system that promotes the Nitrogen Cycle (see [Figure 3.3](#)). Separating the biofiltration system from the water table allows biofiltration systems to be used where the [SHGWT](#) is within two feet of land surfaces and has a number of advantages:

- an anoxic zone is created to facilitate improved nitrogen removal.
- if a permanently wet zone is used, it serves as a source of water for plants within the biofiltration system. The plant root zone must be able to tolerate being wet most of the time. Some BAM mixes retain a residual moisture content and do not have to be resident in a permanently wet zone.
- the underdrain system is not permitted to drain ground water, which can contribute significant nutrient loads to the surface water system. This allows biofiltration systems to be used where the SHGWT is within two feet of land surface.
- the system can be used where there may be concerns about contamination of ground water.
- the system can be used adjacent to structures that may be adversely impacted by ground water, such as building foundations and road foundations.

The major components of a biofiltration system include:

- Pretreatment area (optional) – sediment and trash pre-treatment vegetated buffers, or swales are commonly used (See [Appendix B](#) for sizing sediment sumps).
- Ponding area – typically limited to a depth of 6 to 12 inches
- Ground cover layer and plants – typically 2 to 6 inches of top soil planted with Florida-friendly plants.
- Media – Varies depending on purpose (porosity and filtration)
- Surface inlet and outlet controls – non-erosive inflows and underdrain outflow

As is customary with LID principles, numerous biofiltration systems distributed throughout a catchment instead of a single large stormwater basin or pond help facilitate treatment near the source. Although any one treatment area may be small, the cumulative effect of multiple systems can be significant.

BIOFILTRATION SYSTEM SUMMARY

Advantages/Benefits	Applicable to small drainage areas; applicable to high SHGWT conditions; applicable to Sensitive Karst Areas to limit nitrate movement to the ground water; applicable to highly urban areas with land limitations; can be designed as an aesthetic amenity.
Disadvantages/Limitations	May require an underdrain system, filter media mixture, and landscaping.
Volume Reduction Potential	Low, not a flood control BMP.
Pollutant Removal Potential	Moderate to significant for most pollutants depending on media mixture.
Key Design Considerations	Contributing drainage area usually under 2 acres; separate from SHGWT by structural methods to reduce nitrates; at least 2 inches of top soil, appropriate depth of planting soil, and 24 inches of filter media with a carbon source for nitrate removal; must be able to discharge into an appropriate conveyance system or the ground water.
Key Construction and Maintenance Considerations	Inspect inflow/outflow points for any clogging; inspect pre-treatment BMPs for clogging; inspect prefilter strip vegetated buffer/grass swale and ponding area for erosion or gullyng; inspect trees and shrubs to evaluate their health; inspect the underdrain system to ensure it is not clogged; test planting soil pH every 3 years to ensure between 5.5 and 6.5; if infiltration based, test infiltration rate with double ring infiltrometer or other devices approved by the regulatory agency every 3 years.

5.15.2. Biosorption Activated Media (BAM)

As the use of LID BMPs such as rain gardens and biofiltration became more widespread, the need to develop and evaluate engineered media that were effective in removing stormwater pollutants grew. Over the past decade numerous research projects on BAM have been conducted. Leadership on this research originated in the mid-Atlantic states, the Pacific Northwest, the University of Minnesota, Monash University in New Zealand, University of Florida, and at the UCF Stormwater Management Academy. The objective of this research is to evaluate the feasibility of use and effectiveness of sorption media that are functionalized for

nutrient removal. The term “sorption media” is used as a qualifier for the media because the pollutant removal is primarily by surface bonding to the media or other physical chemical mean for removal. A sorption media that is formulated and tested for specific pollutant removal in a specific stormwater installation is designated as a functionalized sorption media. To predict the nutrient removal value, mathematical equations for nutrient removal chemical means (called Langmuir and Freundlich isotherms) are used. Additional removal may result from biological means including organisms and plants. Particulate matter may be removed from the stormwater by filtration when water is passed through the media.

Sorption media with mixes containing recycled materials, such as cellulose and tire crumb, combined with natural soils such as sand/silt/clay and limestone, are recommended for nutrient removal in stormwater management systems, including filters and retention BMPs. Media for biofilters are targeted at removing a wide range of pollutants from nutrients to heavy metals. Some media for use in retention BMPs are targeted at facilitating the Nitrogen Cycle to minimize the production of nitrates and nitrate loading to the ground water. [Table 5-13.1](#) contains a list of BAM filter media.

Since the water quality focus in Florida is on reducing nutrient loadings to surface and ground waters, the stormwater designer is referred to the publication entitled “Alternative Stormwater Sorption Media for the Control of Nutrients” prepared by the UCF Stormwater Management Academy for the SWFWMD. This publication is available online at:

<http://stormwater.ucf.edu/wp-content/uploads/2014/09/AlternativeMedia2008.pdf>

5.15.3. Applicability

1. Water quantity control

Biofiltration systems are designed primarily as BMPs for addressing stormwater quality. Although biofiltration systems will provide some attenuation of peak flows, they will most likely not provide sufficient storage capacity to meet County or applicable WMD water quantity control criteria.

2. Water quality control

Biofiltration systems use the chemical, biological, and physical properties of plants, microbes, and soils or engineered media (BAM) to remove stormwater pollutants. Biofilters may be especially useful in highly urban areas where land for retention or wet detention systems is scarce and soils are inappropriate for retention systems. For example, roof runoff can be effectively detained and treated in a containerized biofilters such as a planter box. Parking lot runoff can be routed into shallow depressed landscape island rain gardens using curb cuts or into biofilters integrated into the landscaping adjacent to the parking lot. Figures 5.15.1 through 5.15.6 provide illustrations of the several types of biofiltration systems with underdrains. Each of these systems can be installed without an underdrain if the soils will permit infiltration of the treatment volume.

Figure 5.15.1. Plan View Illustrating a Biofiltration System

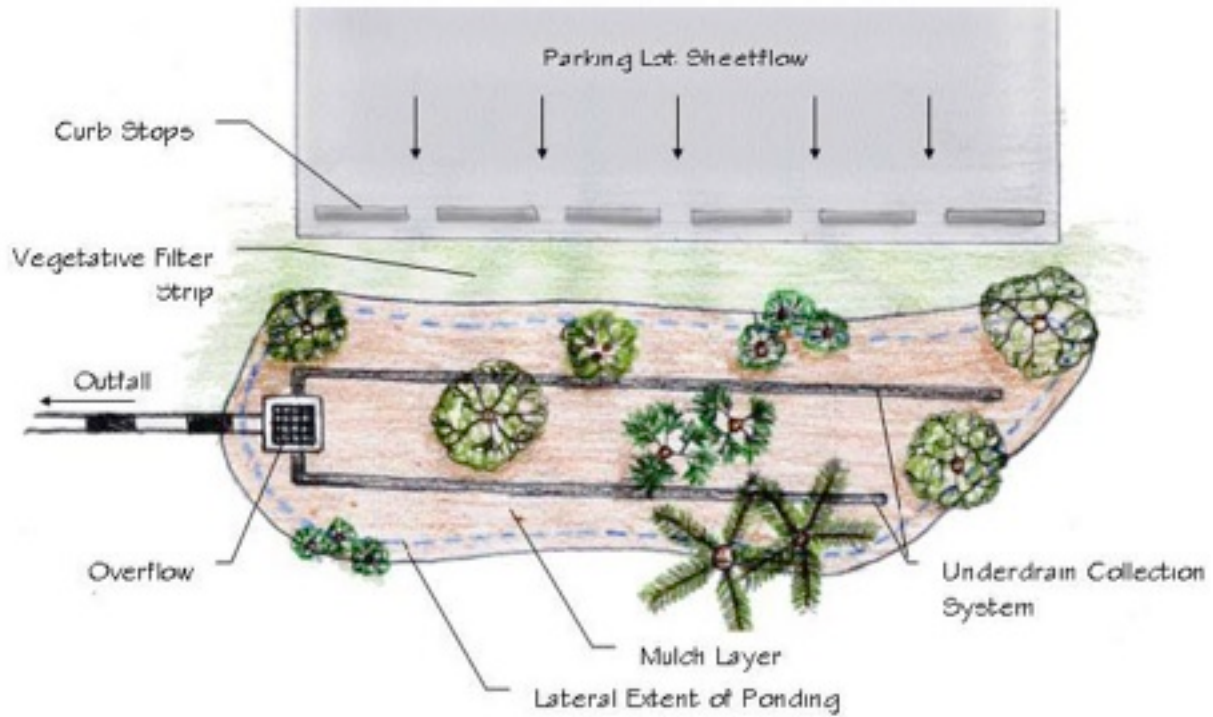

Figure 5.15.2. Cross Section View of a Biofiltration System

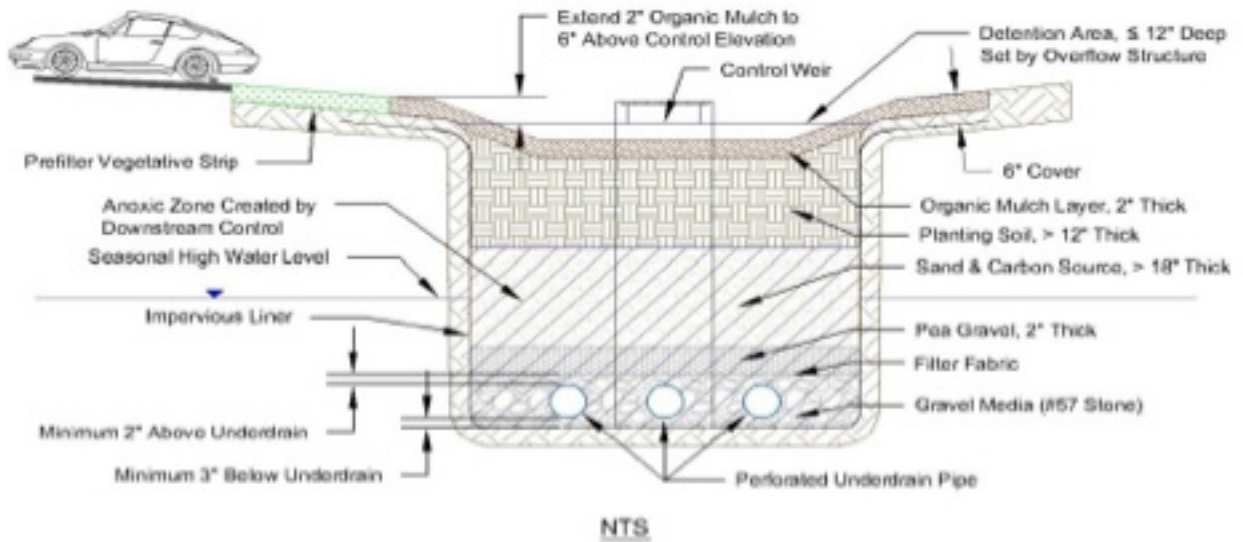

Figure 5.15.3. Example Cross Section View for Nitrate Removal with Overflow

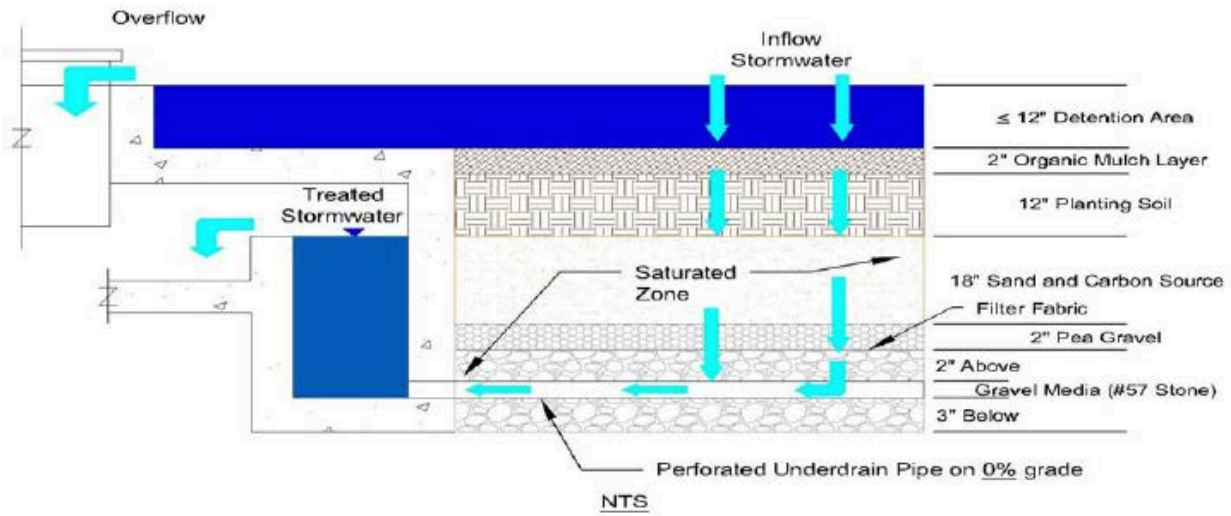

Figure 5.15.4. Example Stormwater Planter Box Biofiltration System

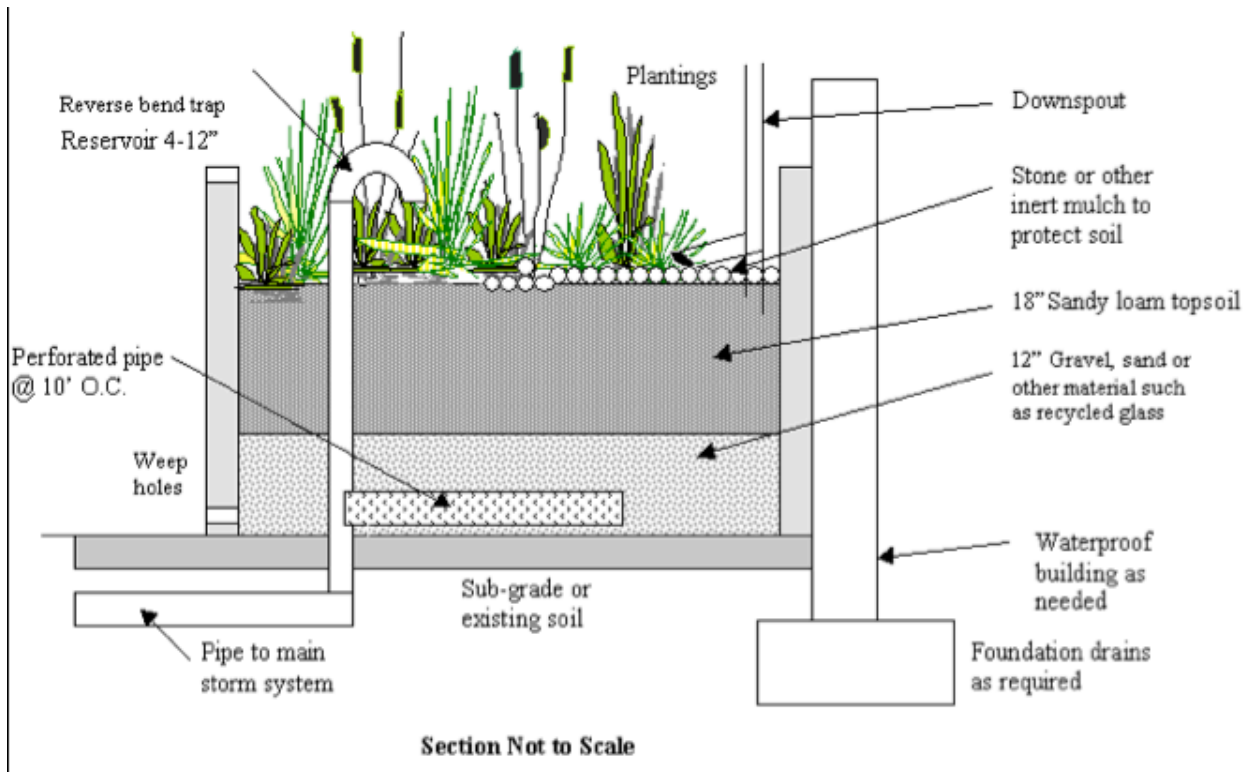

Figure 5.15.5. Example Stormwater Infiltration Planter Box Biofiltration System

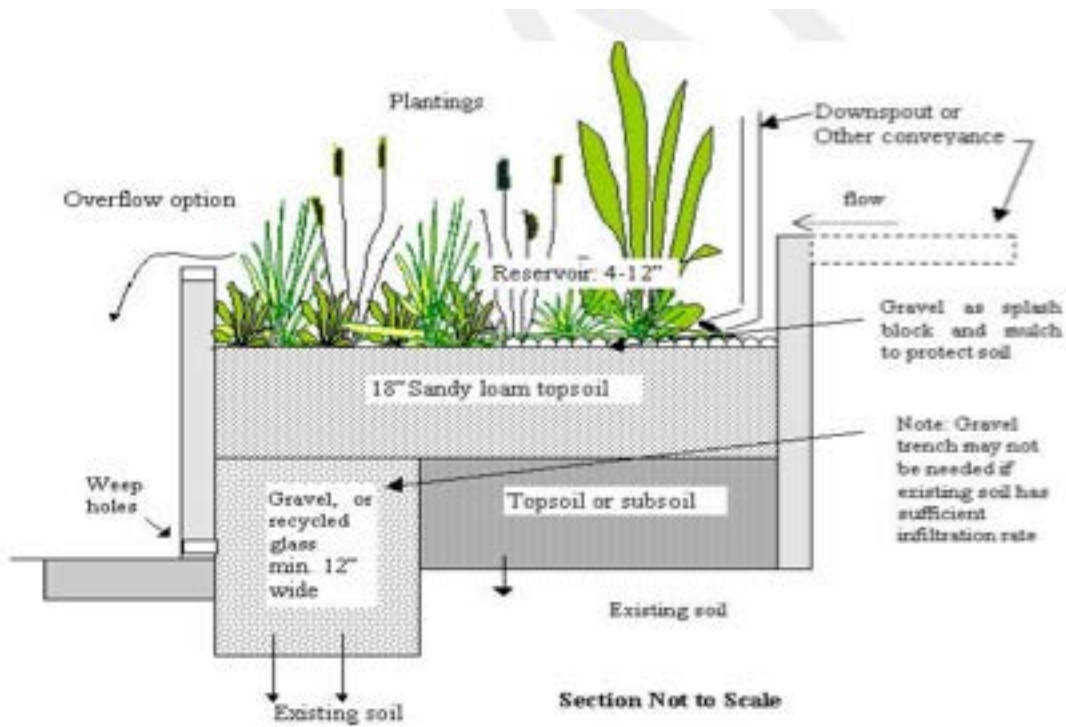
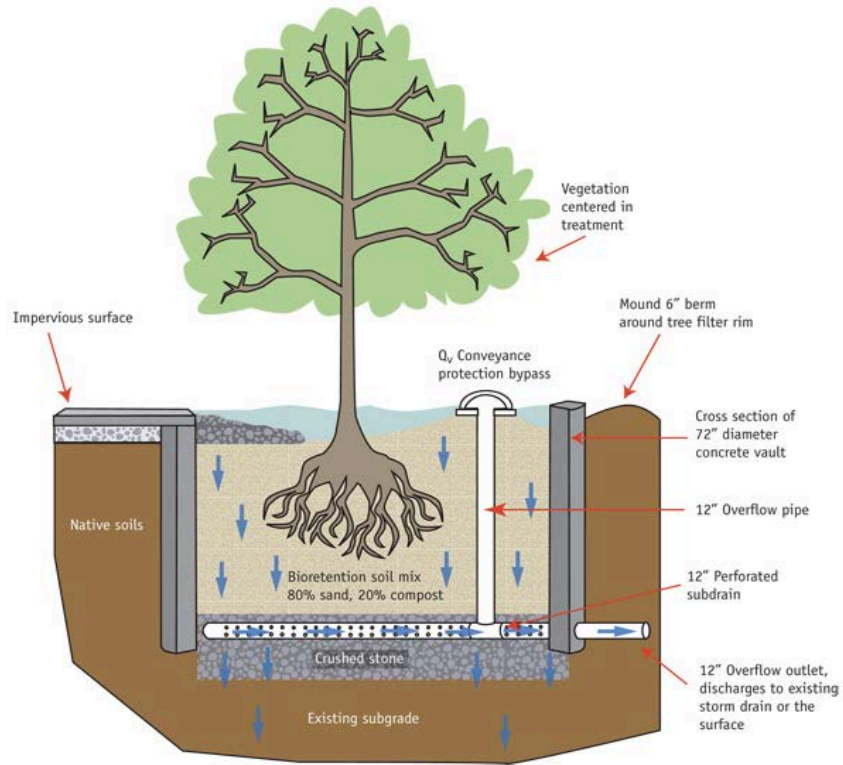

Figure 5.15.6. Stormwater Tree Box Filter System



3. General Feasibility

Biofiltration systems are suitable for many types of development, from single-family residential to high-density commercial projects. Because the shape and sizing of systems are relatively flexible, the systems can be incorporated into many landscaped designs. These systems can be used near [impervious areas](#) such as within roadway medians, parking lot islands, or planter boxes. Biofiltration systems are also well suited for treating runoff from pervious areas, such as recreational fields, golf courses, or landscaped areas. Biofiltration systems may also be used to treat roof runoff, in which case they could be installed with all or a part of the system above ground. If biofiltration systems are installed above ground, the same fundamental design requirements would have to be met as with in-ground biofiltration systems and the biofiltration system would have to discharge through an under-drain system. Biofiltration systems are not suitable for regional stormwater control.

4. Physical constraints

When evaluating the appropriateness of a biofiltration system, a designer should consider some of the physical constraints associated with this type of treatment system, including:

- A. Drainage area – usually less than two acres and preferably less than one acre.
- B. Seasonal high water table – separated by structural means from hydraulic contribution of the surrounding water table if [SHGWT](#) is within 2 feet of the bottom of the system.
- C. Soils – stormwater must pass through the top soil and BAM before entering the ground water or perforated underdrain discharge pipe.
- D. Discharge - when underdrained, the biofiltration system water must be able to discharge into an appropriate conveyance system such as a storm sewer with adequate capacity.

5.15.4. Design Considerations and Requirements

The following criteria are to be considered minimum standards for the design of biofiltration systems in Escambia County. Consult with the NWFWMMD to determine whether any variations must be made to these criteria or if additional standards must be followed.

1. Location and Planning

Biofiltration systems are designed for intermittent flow and should not be used on sites with a continuous flow from ground water, sump pumps, or other sources. Locations of biofiltration systems should be integrated into the site-planning process, and aesthetic considerations should be taken into account in their siting and design. All control elevations must be specified to ensure that runoff entering the facility does not exceed the design depth. Biofiltration systems can be installed partly or fully above ground as a planter box to treat roof runoff. However, these systems must still be lined and drained by an underdrain discharging into an appropriate conveyance system such as a storm sewer with adequate capacity.

2. General Criteria

A detention system with biofiltration must consist of the following:

- A. **Prefilter strip** – Where feasible, a vegetative buffer between the contributing drainage area and the ponding area or swale conveyances must be used to capture coarse sediments and reduce sediment loading to the detention area. The applicant may propose other measures to minimize the sediments entering the biofiltration system. Biofiltration systems that do not include a prefilter strip or other pretreatment measures must include a detailed operation and maintenance plan.
- B. **Ponding area** – An area that provides temporary surface storage (less than 12 inches) for runoff before flowing into and through the soil treatment bed.

- C. **Organic mulch layer (optional)** – If used, a two to three-inch layer that attenuates heavy metals, reduces weed establishment, regulates soil temperature and moisture, and adds organic matter to the soil.
- D. **Planting soil filter bed** – A layer that provides adequate depth of planting media appropriate for the planned vegetation within the basin as well as a sorption site for pollutants and a matrix for soil microbes.
- E. **BAM bed with carbon source (for nitrate removal)** – A layer at least 18 inches thick at the bottom of the biofiltration system that facilitates denitrification under anoxic conditions. This layer also sorbs additional pollutants. If goal is phosphorus removal, a carbon source is not necessary.
- F. **Woody and herbaceous plants** –Florida-Friendly plants that provide a carbon source for the biofiltration system, help facilitate microbial activity, and improve infiltration rates. Roots must be kept away from the underdrain.
- G. **Underdrain (optional)** - A system facilitating the positive drainage of stormwater through the soil/filtration media and into the discharge conveyance system.
- H. **Control structure** - A structure that creates an anoxic zone up to the elevation of the top of the sand layer.
- I. **Energy-dissipation mechanism** – a structure that reduces runoff velocities, distributes flow, and reduces disturbance of the mulch layer.
- J. **Overflow pipe or spillway** – a structure to allow rainfall events that exceed cell volume capacity to bypass the system. The discharge invert should be set no higher than 12 inches above the soil surface with the applicable downstream erosion-control measures.

3. Sizing Requirements

A. Prefilter strip

- The prefilter strip design will depend on topography, flow velocities, volume entering the buffer, and site constraints.
- The prefilter strip is typically a vegetated buffer or swale.
- Inflow to the prefilter should be dispersed with low non-erosive velocities.

B. Ponding area

- The maximum ponding depth must be no more than 12 inches below the overflow structure.
- The recovery time must be less than 36 hours to ensure plant survival.

C. Organic mulch layer (optional)

- The surface organic mulch layer must be at least 2 inches deep and cover the surface of the basin to at least 6 inches above the expected high water line.
- Mulch depth must never exceed 4 inches or soil aeration may be reduced.
- Hardwood mulch must be used due to its higher pH, improved microbial activity, and slower decomposition rate. Examples of acceptable mulches are those made from Melaleuca or Eucalyptus trees. Pine bark or pine straw is not acceptable.
- Partially composted mulch is acceptable, especially in the lower parts of the depression as this will reduce the tendency of the mulch to float.

D. Planting soil filter bed

- The planting soil filter bed must be at least 6 inches thick.
- The bed material must be sandy loam, loamy sand, or loam texture.
- Clay content must be between 3 and 5%.
- Soil pH must be suitable for plant growth.
- Top soil organic matter content must be sufficient to support good plant growth.
- The soil mix must be uniform over the volume used and free of stones, stumps, roots, or other similar material greater than 2 inches in size.

- Field derived hydraulic conductivity for the biofiltration system are typically between 1 to 12 inches per hour. Design hydraulic conductivities must be agreed to in writing during the pre-application meeting.

E. Biosorption Activated Media (BAM)

- The sand bed with a carbon source must be at least 24 inches thick.
- The unit weight must be more than 70 pounds per cubic foot when dry.
- No more than 5% of the particles pass through a #200 sieve.
- The media must be more than 50% uniformly graded sand by volume and must not contain shale.
- The media water holding capacity must be at least 30% as measured by porosity.
- The vertical permeability must be at least 2 inches per hour at the specified unit weight noted above.
- The media must have an organic content at least 5% by volume. The organic content must be in the form of 1-inch hardwood chips (e.g. Melaleuca or Eucalyptus woodchips) evenly distributed throughout the layer.
- The media pH must be between 6.5 and 8.0 or suitable for the selected plant species.
- The concentration of soluble salts must be less than 3.5 g (KCl)/L.
- If interested in phosphorus removal, the sorption capacity of the BAM must exceed 0.05 mg OP/mg media.

F. Under-drain system

1. Pipe

- Underdrain pipe must be at least 2-inch-diameter PVC or HDPE pipe.
- Perforations must meet the AASHTO M 36 or M 196 requirements.
- Pipe must be spaced no more than 10 feet apart on center.
- Pipes shall have a positive drainage even under high tailwater conditions.

2. Gravel media

- Pipe must be laid on 3 inches of double-washed no. 57 aggregate and then filled around both sides of the pipe and over the top at least three (3) inches. If pea gravel is used, a minimum of 6 inches of fill is required.
- Gravel must extend to the full width and length of the Sand and Carbon Source Layer to allow for an even flow through this layer
- The course gravel layer must be overlaid with non-woven, non- degradable filter fabric that meets the geotextile requirements provided [in FDOT Design Standards Index No. 199](#) for Geotextile Type D-3.
- Filter fabric must be covered with 2 inches of ¼-inch to ½-inch double-washed pea gravel to reduce the likelihood of clogging.

3. Control structure

- A control structure that creates an anoxic zone to the top of the sand layer must be placed downstream of the underdrain system if nitrate removal is the target.
- The control structure must be designed to preclude a siphon from forming.
- The control structure must be designed so that it does not inhibit maintenance and cleanout of the underdrain system.

4. Discharge Requirements

The biofiltration system is primarily a water quality treatment system and does not need to meet any specific discharge requirements. However, an overflow structure and non-erosive overflow

channel must be provided to safely pass flows that exceed the storage capacity of the biofiltration system to a stabilized downstream area or conveyance system. The complete stormwater treatment system for the site must meet County water quantity discharge requirements.

5. Recovery Requirements

The appropriate Florida-registered professional must demonstrate through an underdrain recovery calculation or by underdrain recovery modeling that under high tailwater conditions there is no standing water in the biofiltration system 36 hours after the stormwater treatment volume is applied. The assumed hydraulic conductivity for the planting soil must be stated clearly as this will be used when testing biofiltration systems.

6. Stormwater Quantity Credits

Biofiltration systems typically are used for stormwater treatment and not for flow attenuation. However, the effectiveness of a biofiltration system at attenuating peak flows can be calculated using one of the following procedures:

- Calculating the curve number (CN) for the biofiltration area and including this in the area weighted CN for the entire site.
- Explicitly modeling the hydraulic functioning of the biofiltration system— including the underdrain and overflow control structures.

7. Stormwater Pollutant Load Requirements/Credits

No specific treatment requirement is associated with a single biofiltration system. These systems are intended to be part of a BMP treatment train, where each practice in the train provides incremental water quality benefits. The level of treatment that can be expected from these systems is based on the average annual volume of water captured and filtered by the biofiltration system and the pollutant load removal efficiency of biofiltration system.

The annual average pollutant-load reduction for metals, nitrogen, and phosphorus must be calculated for a biofiltration system to be considered part of the water quality treatment. Removal efficiencies for all three constituents must be developed using one of the following methods:

(a) Assumed efficiencies:

Using two feet of Biosorption Activated Media (BAM), one [blend](#) can remove 75% of the annual average nitrogen load reduction and 95% of the phosphorus load. There are other BAM mixes that remove less. All levels of treatment are presumed for biofiltration systems that are designed to the minimum recommended design criteria in this Manual. Systems that are designed with substantial deviations from the design criteria will require the removal efficiency to be determined for the specific design in discussions with the County staff at the pre-application meetings. Additionally, the system effectiveness will need to be confirmed using water quality monitoring for a duration and frequency agreed to by the County Staff at the pre-application meetings. If the assumed removal efficiencies are found to exceed the measured removal efficiencies, the County may request that the property owner perform on-site mitigation to achieve the permitted removal efficiencies.

(b) Literature values:

These must be agreed to in writing by County staff at the pre-application meeting.

The percentage of the average annual runoff volume that is filtered by the biofiltration system may be estimated by using one of the following methods:

- (a) Continuous simulation - a continuous simulation of the biofiltration system using an applicable long-term rainfall record (at least 20 years).
- (b) Design Curve – Figure 5.15.7 is used to determine the percentage of the average annual volume of water filtered or captured by the biofiltration system. This figure requires that the equivalent impervious area (EIA) and detention volume are known. The EIA is equal to the mean annual runoff coefficient multiplied by the drainage area. Be sure to treat directly connected impervious area as 100% DCIA rather than having a CN of 98.

The average annual pollutant load reduction can then be calculated by multiplying the removal efficiency by the percentage of the average annual runoff that is captured and filtered by the biofiltration system. For example, a filter that captures 53% of the average annual runoff volume (Figure 5.15.7 triangle) and has a removal efficiency of 75% for nitrogen 95% for phosphorus will result in a 40% (0.75 x 0.53) average annual nitrogen and 50% (0.95 x 0.53) annual phosphorus load reduction.

Figure 5.15.7. Example Average Annual Runoff Capture Efficiency of a Biofiltration System in Escambia County for Specific Conditions

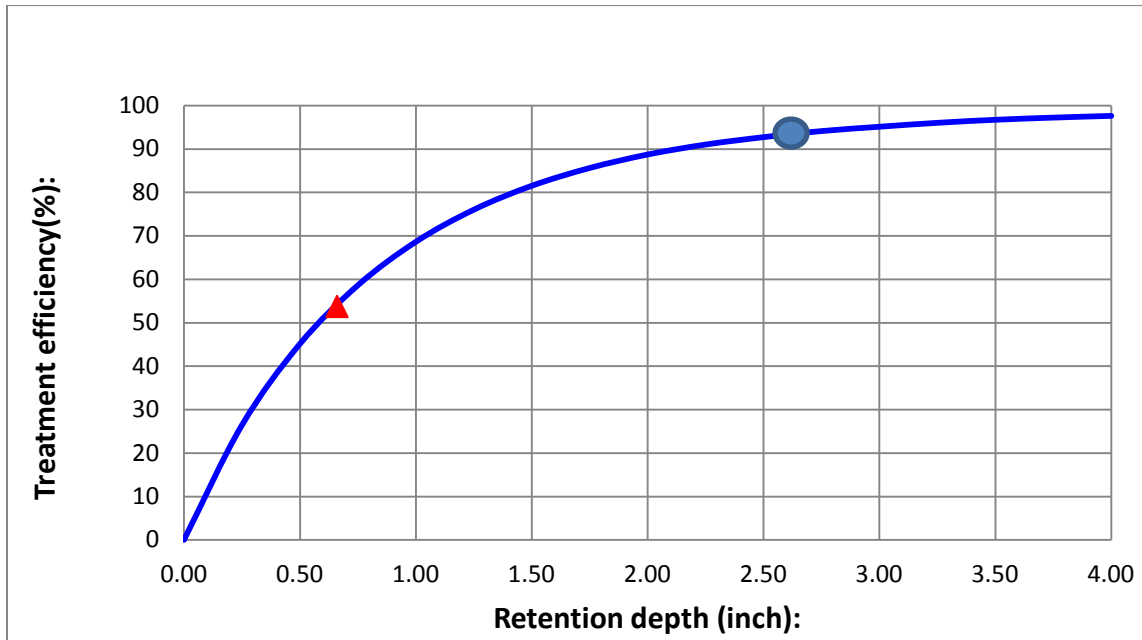

8. Maintenance Access

Access to the biofiltration system must be provided at all times for inspection, maintenance, and landscaping upkeep. There must be sufficient space around the biofiltration system to allow accumulated surface sediments to be removed and possibly for underdrains to be cleaned out or replaced if they should fail infiltration tests or inspection. To facilitate maintenance of the underdrain system, capped and sealed inspection and cleanout ports that extend to the surface of the ground must be provided at the following locations for each drainage pipe at a minimum:

- (c) The beginning and end of each run of pipe.
- (d) At every 50 feet or every bend of greater than 45 or more degrees, whichever is shorter.

9. Safety Features

Due to their shallow ponding depth, biofiltration systems generally do not require any special safety features such as fencing. Railings or a grate can be used to address safety concerns if the area is designed with vertical walls.

10. Landscaping

Landscaping enhances the performance and function of biofiltration systems. Selecting plant material based on hydrologic conditions in the basin and aesthetics will improve plant survival, public acceptance, and overall treatment efficiency. Native or Florida-friendly plants should be selected. All landscaping recommendations should be considered before storm flows are conveyed to the biofiltration system. The following considerations for the landscaping in the contributing drainage area must be followed:

- (a) The unpaved contributing area should be well vegetated to minimize erosion and sediment inputs to the biofiltration system.
- (b) Where feasible, a prefilter vegetative strip or vegetative swale should be installed.
- (c) If used, trees should be spaced 12 to 15 feet apart depending on the type.
- (d) Plants should be placed at irregular intervals.
- (e) If woody vegetation is used, it should be placed along the banks and edges of the biofiltration system, not in the direct flow path.
- (f) Only species well adapted to the regional climate should be used.
- (g) Species planted in well-drained media should tolerate short-term ponding as well as periods of low soil moisture.
- (h) Plants in the vicinity of the underdrains shall not have extensive root systems that can damage the underdrains.

5.15.5. Biofiltration Design Procedure

The following procedures are intended to guide an applicant through the design of a detention system with biofiltration:

- A. Step 1 – Determine if the development site and conditions are appropriate for the use of a biofiltration system. Consider the Application and Site Feasibility Criteria discussed earlier.
- A. Step 2 – Determine the drainage area and the equivalent impervious area (EIA) for the drainage area. [EIA = C x Drainage Area].
- B. Step 3 – Compute the maximum capture volume that will be detained in the surface storage of the biofiltration system (maximum depth 12 inches).
- C. Step 4 – Set design elevations and dimensions of facility.
- D. Step 5 – Design a pretreatment system if practicable — either a sediment trap, a vegetative buffer, prefilter strip, or vegetative swale.
- E. Step 6 – If an underdrain is used, size the underdrain system and downstream control structure.
- F. Step 7 – Design the emergency overflow. An overflow must be provided to bypass and/or convey larger flows to the downstream drainage system or stabilized watercourse. Non-erosive velocities need to be ensured at the outlet point.
- G. Step 8 – Determine the Average Annual Pollutant-Load Reduction. This annual average pollutant-load reduction for TN and TP must be calculated.
- H. Step 9 – Calculate the peak attenuation credit.
- I. Step 10 – Prepare the vegetation and landscaping plan. A landscaping plan for the biofiltration system should be prepared to indicate how the area would be established with vegetation.

5.15.6. Biofiltration Design Example

Assume that a stormwater BMP is needed to help meet the water quality objectives of a site. The portion of a site analyzed in the example includes one acre of paving plus an area that is 80 feet by 30 feet to be used for a biofiltration system. The following are sample calculations for determining the pollutant load removal efficiency of a biofiltration system.

- A. Step 1 – Assume that the applicant has determined that the site meets the criteria specified in [5.15.2](#) and [5.15.3](#). Therefore, a biofiltration system is an appropriate choice for a BMP on this site.
- B. Step 2 – The contributing area is a one acre paved surface plus a 0.06-acre biofiltration system. The mean annual runoff coefficient for the paved surface and the biofiltration surface is 0.849. Therefore, the EIA for the paving and the biofiltration system is 0.90 acre = $[1 * 0.849 + 0.06 * 0.849]$.
- C. Step 3 – The area available for the biofiltration system is limited to approximately 80 feet by 30 feet (Area at top of storage = $80 * 30 = 2400$ sf). Therefore, using a maximum detention depth of four feet, and assuming a side slope of 3:1 the maximum detention volume detained is calculated to be about 8300 cubic feet.
- D. Step 4 – Biofiltration design data are specified, such as the design elevations and the treatment rate. Treatment rate must consider the expected life time of the design and as such must be modified to account for decreased in rate over time. A design safety factor of two (2) is typical. As an example, a design rate of 2 inches per hour is based on a rate of 4 inches per hour when using laboratory of double-ring infiltration data.
- E. Step 5 – Assume that the applicant has found that there is sufficient space for a prefilter strip. If the biofiltration system also incorporates infiltration, having a prefilter reduces the frequency of infiltration rate testing to once every 3 years, rather than once every 18 months, which is required if no prefilter strip is included.
- F. Step 6 – The applicant then sizes the underdrain to recover in 72 hours and to create the anoxic zone for nitrate removal. This assumes that a design (safety) factor of two is used for the treatment rate. If the treatment rate is not divided by two (safety factor), then the recovery must take place in 36 hours (applying the design factor to the recovery time).
- G. Step 7 – Ensure that flood control is provided to meet Escambia County requirements.
- H. Step 8 – The average annual pollutant removal efficiency would be calculated. Dividing the detention volume by the EIA gives a treatment volume of 2.6 inch over the EIA ($8300 \text{ cf} / .872 \text{ acre} * 12 / 43560$). [Figure 5.15.7](#) shows that approximately 96% of the average annual runoff (see circle in the Figure) would be captured for filtration by the biofiltration system. Given that the filtration system provides a 75% removal of nitrogen, it can be calculated that the system would achieve a 72% reduction ($0.75 * 0.96$) in nitrogen loading from the paved area.

5.15.7. Operation and Maintenance

- A. Operation and maintenance entity must conduct regular inspections of the biofiltration system immediately after a rainfall to ensure it is operating as permitted. At a minimum, an inspection should occur in the spring, before the rainy season begins in June, and during the rainy season. At a minimum the following should be inspected:
 - Inspect inflow/outflow points for any clogging.
 - Inspect prefilter strip vegetated buffer/grass swale and ponding area for erosion or gullyng.
 - Inspect trees and shrubs to evaluate their health.
 - Inspect the underdrain system to ensure it is not clogged.

- B. Maintenance - Any problems identified during the routine inspection must be corrected as soon as possible. To ensure the system is properly maintained and to continue to receive stormwater treatment credits, the operation and maintenance entity must:
- Prune and weed to keep any structures clear.
 - Maintain/mow the vegetated buffer, prefilter strip or swale at least twice during the growing season and remove clippings from the flow path.
 - If used, replace mulch where needed when erosion is evident.
 - If used, replace mulch over the entire area every 2 to 3 years.
 - Remove trash and debris as needed.
 - Remove sediment from inflow system and outflow system, including underdrains, as needed. Flush underdrains as needed to maintain their flow capacity.
 - Stabilize any upstream erosion as needed.
 - Remove and replace any dead or severely damaged vegetation.
- C. Recertification Inspection and Testing - The operation and maintenance entity is required to provide for the inspection of the entire stormwater management system by a Florida registered professional to assure that the system is properly operated and maintained. The inspections shall be performed 18 months after operation is authorized by the County and every 18 months thereafter. The report is due to the County within 30 days of the date of inspection.

A Florida-[registered professional](#) must conduct testing to provide reasonable assurance that the biofiltration system is functioning as intended. Results, as well as remedial actions, must be reported to the County. For sites that include a large number of biofiltration systems, a testing schedule in which a representative sample of biofiltration systems are tested at the appropriate interval may be agreed to at the pre-application meeting or during the permitting process. Testing must include the following:

- The planting soils pH must be tested at least once every 3 years. Planting soils pH must be suitable for the plants used.
- Biofiltration systems that include infiltration components require that a double-ring infiltration test be performed every 3 years at up to three locations in the bottom of the basin to confirm design infiltration rates. An alternative to the double-ring is staff gage depth measurements from a ponded area. The staff gage is preferred for operating systems. If two out of three tests are below the design treatment rate criteria or the average rate of the three tests is below the design criteria, the biofiltration system media must be restored. Core aeration or cultivating of non-vegetated areas may be sufficient to ensure adequate filtration.

5.15.8. Planter Box Biofiltration Systems

All of the above requirements for biofiltration systems apply to Planter Box biofilters unless they are superseded by specific requirements below.

1. **Description** - Planter box biofilters are structural landscaped reservoirs used to collect and filter stormwater, allowing pollutants to settle and filter out as the water percolates through the vegetation, growing medium, and gravel.

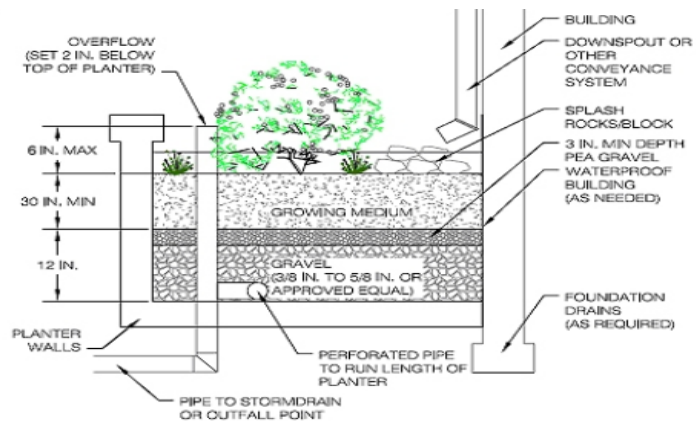

Excess stormwater collects in a perforated pipe at the bottom of the flow through planter and drains to an approved discharge point and conveyance. Planters can be used to help fulfill a site's required landscaping area requirement and should be integrated into the overall site design. Numerous design variations of shape, wall treatment, and planting scheme can be used to fit the character of a site. Because flow-through planters can be constructed immediately next to buildings, they are ideal for sites with setback requirements, poorly draining soils, or other constraints. All of the above requirements for biofiltration systems apply to Planter Box biofilters unless they are superseded by specific requirements below.

2. **Setbacks** - Biofiltration planters that rely on infiltration are typically set back 5 feet from property lines and 10 feet from building foundations. No setbacks are required for lined flow-through planters where the height above finished grade is 30 inches or less. Lined flow-through planters can be used next to foundation walls, adjacent to property lines, or on slopes when they include a waterproof lining.
3. **Contributing drainage area** - The maximum contributing drainage area is 2,500 sq. ft. However, this is considered a general rule. Larger drainage areas may be allowed by Escambia County if the biofiltration system has sufficient flow controls and other mechanisms to ensure proper function, safety, and community acceptance. The drainage areas in these urban settings are typically considered to be 100% impervious.
4. **Planter biofiltration system sizing and pollutant load reduction** - Planter biofiltration systems that use infiltration and are not underdrained can be sized similar to retention basins by using [Table A2-1](#) to determine the desired treatment volume. The treatment volume will then determine the annual load reduction percentage. If the biofiltration system requires an underdrain and discharges off-site, the desired treatment volume and the biofiltration media characteristics will determine the area of the biofiltration system. These, in turn, will determine the pollutant load reduction. The treatment volume is determined from the sustainable porosity of the media.
5. **Dimensions and slopes** - The minimum infiltration planter width is 30 inches, and the minimum flow-through planter width is 18 inches (measured from inside the planter walls). Storage depth must be between 6 and 12 inches (from inlet elevation of overflow to top of growing medium). Planters are flat facilities that do not slope more than 0.5 percent in any direction. A minimum of 2 inches of freeboard (vertical distance between the design water surface elevation and overtopping elevation) shall be provided.
6. **Planter walls** - Planter walls shall be made of stone, concrete, brick, or other durable material. For planters that require an impervious bottom, a single-pour concrete solution is preferred. Chemically treated wood that can leach out toxic chemicals and contaminate stormwater shall not be used.
7. **Liners** - Flow-through facilities that require an impervious bottom can use either a waterproof liner (geomembrane) or a single-pour concrete box. If lined, there are many liner options, and installation varies. Liners should be installed to the high water mark. Liner shall be 30 to 40- mil PVC or HDPE as appropriate or approved equivalent.
8. **Vegetation** - The entire planter box filter must be planted with vegetation. The facility area is equivalent to the total area of the planter, as developed in the sizing calculations. The entire surface area of a planter is inundated with water and therefore requires plants that will survive such conditions. Minimum quantities are shown below:

<i>NUMBER OF PLANTS/100 sq.ft.</i>	<i>TYPE OF PLANTS</i>	<i>SIZE</i>	<i>SPACING ON CENTER</i>
115	Herbaceous	1 gallon	1'
OR			
100	Herbaceous	1 gallon	1'

4	Small shrubs	1 gallon	2'
---	--------------	----------	----

Tree planting is not required in planters but is encouraged where practical. Tree planting is also encouraged near planters.

- Construction Considerations** - Special attention should be paid to the structural waterproofing if the planter is constructed adjacent to building structures.

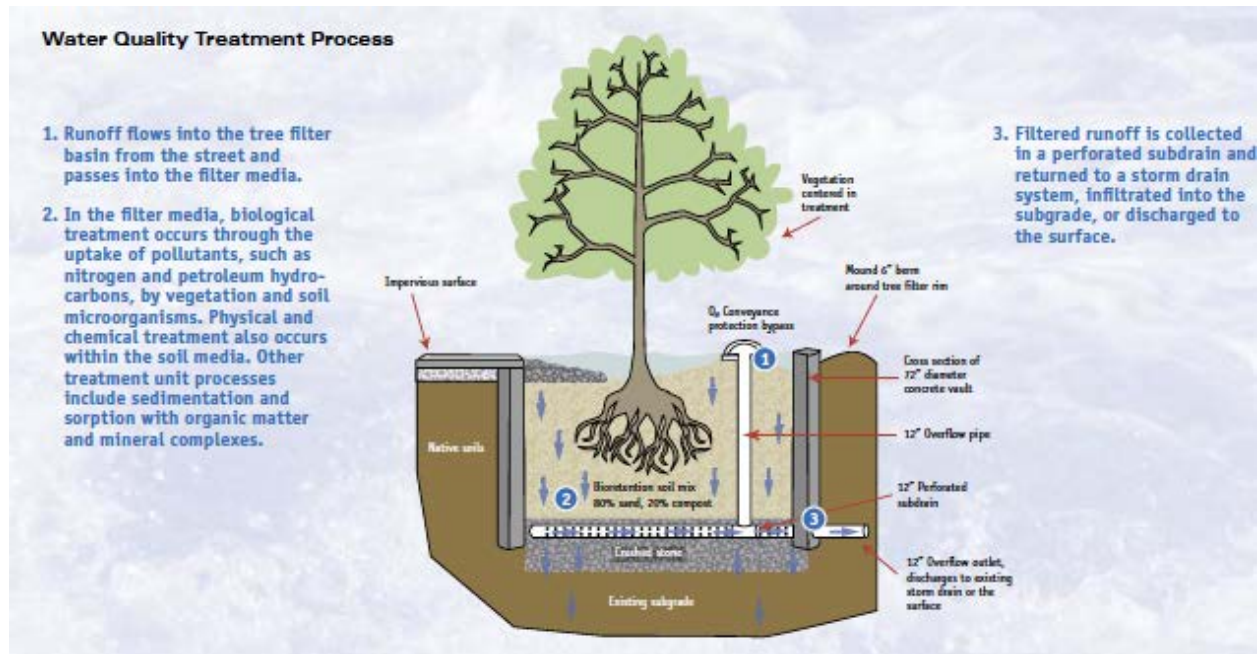

5.15.9. Tree Box Filter Systems

- Description** - Tree box filters typically are pre-cast concrete boxes filled with biofiltration media installed below grade at the curb line.

A standard street tree or shrub is planted in the box, which resembles a curbside planter. Tree box filters are located upstream of a standard curb inlet. For low to moderate flows, stormwater enters through the tree box's inlet, filters through the soil, and exits through an underdrain into the storm drain. When the tree box filter is full, excess street flows will bypass the tree box filter and flow directly to the downstream curb inlet. They serve as attractive landscaping and stormwater catch basins. Unlike many other forms of urban landscaping, they are not isolated behind curbs and deprived of water and nutrients in runoff. Their water quality treatment performance is moderate, depending on the size and composition of the filter media. On sites where the soils are appropriate for infiltration, the tree box filter should be designed following the recommendations for Interceptor Trees.



2. **Applicability** - Tree box filters can be used throughout Florida, and are especially useful in highly urbanized settings where available space is at a premium. They can be installed in open- or closed-bottomed chambers where infiltration is undesirable or not possible, such as clay soils, sites with high groundwater, and areas with highly contaminated runoff.
3. Tree box filters are often installed along urban sidewalks, but they are highly adaptable and can be used in most development scenarios. In urban areas, tree filters can be used in the design of an integrated street landscape—a choice that transforms isolated street trees into stormwater filtration devices. They also can be used in designs that seek to convert entire non-functional streetscapes into large stormwater filtration systems.
4. **Water quantity benefits** - Individual tree box filters hold a relatively small volume of stormwater (100-300 gallons), but concerted use throughout a contributing drainage area will decrease the total volume and peak flow rate of discharged stormwater. Tree box filters are designed to capture the water quality volume of stormwater. They are not intended to capture larger volumes or to detain the water quality volume for extended periods of time, however.
5. **Water quality benefits** - Tree box filters remove pollutants through the same physical, chemical, and biological mechanisms as other biofiltration systems, and have moderate removal rates for pollutants in stormwater. They also provide the added value of aesthetics while making efficient use of available land for stormwater management.
6. **Design Criteria**
 - (e) **In general**, tree box filters are sized and spaced much like catch basins, and design variations for these systems are abundant. The tree box filter's basic design is a concrete vault filled with a biofiltration media, planted with vegetation, with an underdrain. The bottom is usually closed unless the soils are appropriate for infiltration.
 - (f) **Soil volume requirements** – When planting trees, the volume of soil provided must be considered carefully. It must be adequate for root development or the tree will not grow to a full size, and its health may be impacted. At maturity, tree roots often extend more than twice as far as the tree's canopy. In urban settings, that ideal volume is usually not available, but the reduction in volume of soil will directly impact the potential size of the tree. A tree box containing 120 ft³ (in a typical 4' x 10' x 3' tree box) might allow a tree to spread to about 10 ft. diameter canopy before it declines. The same tree in a box containing 500 ft³ could be expected to grow to a diameter of more than 20 ft. Void spaces in the soil are also necessary for the tree to obtain both water and air, so it is important that the surrounding soil is uncompacted. Several good design references for tree boxes include:
 - <http://caseytrees.org/resources/publications/treespacedesign/>
 - <http://caseytrees.org/wp-content/uploads/2012/02/tree-space-design-report-2008-td.pdf>
 - http://www.davey.com/media/183712/Stormwater_to_Street_Trees.pdf
 - (g) **Tree species** -Consult an arborist to determine the appropriate species for the system. The trees must be able to tolerate periods of drought and soil saturation. The trees selected shall be [Florida-friendly](#) suitable species for the site conditions and the design intent. Plants with aggressive root growth may clog the underdrain, and therefore may not be suitable for this type of system. The tree box filter can be sized for a specific stormwater treatment volume and should allow for four to six inches of ponding. Larger storm events will be bypassed.
 - (h) **Tree box components** - Tree box filters consist of a pre-cast concrete container, a mulch layer, biofiltration media mix, observation and cleanout pipes, underdrain pipes, one street tree or large shrub.

- (i) **Contributing drainage area** - Tree boxes typically treat runoff from a drainage area of a 0.25 acre or less, although drainage area size is a function of tree box filter size. and
- (j) **Location and spacing** - Tree boxes must be regularly spaced along the length of a corridor as appropriate to meet the desired annual treatment target. A standard curb inlet must be located downstream of the tree box filter to intercept bypass flow. Tree box filters are off-line devices and should never be placed in a sump position (i.e. low point). Instead, runoff should flow across the inlet (e.g. left to right). Also, tree box filters are intended for intermittent flows and must not be used as larger event detention devices. Consideration needs to be given to street lights, signage, and traffic site distances.
- (k) **Inspection and maintenance** - Tree box filters should be inspected annually in the spring before the rainy season begins. To ensure proper performance, visually inspect that stormwater is infiltrating properly into the tree box filter. Excessive volumes of stormwater bypassing the tree box filter to the standard inlet may indicate operational problems. Corrective measures to restore performance include inspection for accumulated sediments and debris and removal, if necessary. In instances where the condition of the soil media has degraded significantly, the media and vegetation should be removed.
- (l) **Routine maintenance** consists of regular removal of trash and debris and vegetation maintenance. The mulch will need to be replenished one (1) to two (2) times per year. The cleanout pipe can be used to flush the system if the underdrain becomes clogged. During extreme droughts, the trees or shrubs may need to be watered in the same manner as any other landscaping. The plants may need to be replaced every few years.

CHAPTER 6. REGULATORY FRAMEWORK FOR LID BMPS

6.1. Introduction

As with any BMPs for stormwater treatment, LID practices must comply with [Escambia County Land Development Code](#) requirements as well as the criteria adopted by the NFWFMD in Environmental Resource Permitting [Applicant's Handbook Volume II](#). These requirements are not identical, but stormwater treatment systems incorporating the LID BMPs in this Manual can be designed in a manner that complies with all regulatory criteria. The purpose of this chapter is to describe the institutional and technical basis for Florida's stormwater treatment rules; describe how the criteria in ERP rules are applicable to stormwater treatment systems incorporating LID BMPs; and to discuss the ERP "permit-ability" of the LID BMP designs in this Manual.

As a condition of permit issuance, ERP rules require that an applicant demonstrate a proposed stormwater system will not adversely affect water resources and ensure the stormwater discharge does not cause or contribute to violations of state water quality standards. Other conditions of issuance generally applicable to the design of stormwater treatment systems incorporating LID practices address flood protection, effectiveness of system performance and function, protection of wetlands, fish and wildlife, and maintenance of minimum flows and levels established pursuant to [Chapter 373.042, F.S.](#) Applicants are advised to consult [Chapter 62-330, F.A.C.](#), and the NFWFMD ERP Applicant's Handbooks, [Volume I](#) and [Volume II](#), for a complete understanding of all applicable ERP criteria. Similarly, the [Escambia County Land Development Code](#) requires that an applicant demonstrate a proposed system will have no discharge from any stormwater management facility that causes or contributes to a violation of water quality standards in waters of the State as provided for in State Statutes.

6.2. Institutional and Technical Framework for Florida's Stormwater Treatment Rule

Recognizing it was much easier and cheaper to prevent stormwater pollution than to restore polluted water bodies, and that Florida's growth was booming, Florida was the first state in the United States to adopt a statewide rule requiring that stormwater from all new development and redevelopment be managed for both flood control and water quality protection.

Florida's stormwater treatment rule was implemented in February 1982. The **technology-based rule** was based on a "**performance standard**" or treatment goal and the adoption of **design criteria** for stormwater treatment BMPs that would achieve the desired average annual pollutant load reductions. The performance standard initially was set at 80% average annual load reduction of Total Suspended Solids. This provided equitability with the minimum level of treatment for point sources, such as wastewater discharges, which was secondary treatment.

In 1989, the Florida Legislature enacted legislation modifying Chapters 373 and 403, F.S., to increase the effectiveness of Florida's stormwater rules in reducing stormwater pollution and to clarify the roles of FDEP, the WMDs, and local governments. The state's stormwater management program was outlined in three sections of Chapter 403, F.S.:

- [Section 403.0891](#), "State, regional, and local stormwater management plans and programs," establishes the institutional roles of the DEP, WMDs, and local

governments in implementing the stormwater program. This section also requires the Florida Department of Transportation to inventory and map primary stormwater management systems that it builds, operates, or maintains. The DEP, in coordination and cooperation with the WMDs and local governments, is to conduct a continuing review of the costs of stormwater management systems and the effects on water quality and quantity, and fish and wildlife values.

- [Section 403.0893](#), "Stormwater funding, dedicated funds for stormwater management," authorizes local governments to create stormwater utilities and stormwater management system benefit areas.
- [Section 403.0896](#), "Training and assistance for stormwater management system personnel," requires the development of training and assistance programs for persons responsible for designing, building, inspecting, or operating and maintaining stormwater management systems.

Furthermore, the legislation directed FDEP to adopt a "Water Resource Implementation Rule" to ensure consistency among rules adopted by DEP, water management districts, and local governments. [Chapter 62-40](#), FAC, was first adopted in 1990. Section 62-40.431 outlines the goals of the state's stormwater management program and the roles and responsibilities of DEP, the water management districts, special districts, and local governments. The overall goal of the program is set forth in Section 62-40.431(2)(a):

The primary goals of the state's stormwater management program are to maintain, to the maximum extent practical, during and after construction and development, the pre-development stormwater characteristics of a site; to reduce stream channel erosion, pollution, siltation, sedimentation and flooding; to reduce stormwater pollutant loadings discharged to waters to preserve or restore designated uses; to reduce the loss of fresh water resources by encouraging the recycling of stormwater; to enhance ground water recharge by promoting infiltration of stormwater in areas with appropriate soils and geology; to maintain the appropriate salinity regimes in estuaries needed to support the natural flora and fauna; and to address stormwater management on a watershed basis to provide cost effective water quality and water quantity solutions to specific watershed problems.

The minimum stormwater treatment performance standards for the state's stormwater program are set in Section 62-40.432(2):

(m) When a stormwater management system complies with rules establishing the design and performance criteria for such systems, there shall be a rebuttable presumption that the discharge from such systems will comply with state water quality standards. The Department and the Districts, pursuant to Section 373.418, F.S., shall, when adopting rules pertaining to stormwater management systems, specify design and performance criteria for new stormwater management systems which:

1. Achieve at least 80 percent reduction of the average annual load of pollutants that would cause or contribute to violations of state water quality standards.
2. Achieve at least 95 percent reduction of the average annual load of pollutants that would cause or contribute to violations of state water quality standards in Outstanding Florida Waters.
3. If a District or the Department adopts basin-specific design and performance criteria in order to achieve an adopted TMDL or the pollutant load reduction goals established in a watershed management plan, such design and performance criteria shall replace those specified in subparagraphs 1. and 2. above.

In 1994, the Legislature created the Environmental Resource Permitting (ERP) program to streamline permitting by combining stormwater flood control, stormwater treatment, and wetlands protection into a single permit. Today, the stormwater treatment rules and BMP design criteria implemented by the FDEP and the WMDs are set forth in the Statewide ERP rule, Chapter 62-330, F.A.C.

Stormwater treatment is still a very young science with advances in the knowledge and understanding of BMP design and treatment performance frequently occurring. Therefore, having dynamic BMP design criteria is critical to the long-term success of the program's BMPs in meeting the desired stormwater treatment performance standards. The BMP design criteria were changed several times during the 1980s as more data on BMP effectiveness in reducing stormwater pollutants became available. Between 1995 and 2010 FDEP funded many projects to evaluate the effectiveness of BMPs, to better understand the relationships between design criteria and average annual pollutant load reduction, and to establish design criteria and effectiveness data for a new suite of BMPs called "Low Impact Design" BMPs. Many of these publications can be accessed from the links on the [Acknowledgement](#) page.

Using the results from these projects, DEP and the WMDs were able to develop relationships between LID BMP design criteria and treatment effectiveness in 2010. While these LID BMP design criteria currently are not in the ERP Applicant Handbooks, DEP and the WMDs are using them to permit stormwater treatment systems that incorporate LID BMPs. In particular, the LID BMP design criteria are being used to help projects achieve the "Net Improvement" performance standard for projects located within the watersheds of water bodies that are not meeting water quality standards. They also are being used in urban redevelopment projects to minimize the land required for stormwater management. The LID BMP design criteria in this Manual are updated versions of the initial LID BMP design criteria. They incorporate results of LID BMP monitoring and research projects completed since 2010.

6.3. Compatibility with State Environmental Resource Permitting (ERP) Rules

Development and redevelopment projects in Escambia County are likely to also require permits under the Statewide Environmental Resource Permitting Rules (Chapter 62-330, Florida Administrative Code). Both State and County requirements for stormwater management share the common goal of ensuring that stormwater discharges do not cause flooding or cause or contribute to violations of State water quality standards. This Manual is written with the intent of being compatible with State rules. Applicants should be cautioned, however, that some of the thresholds, criteria and design standards in this Manual are not necessarily identical to those in State rules.

6.4. Presumptive Criteria and LID BMP Design Criteria

The ERP Applicant's Handbooks identify the procedures and information used in evaluating a stormwater management system for compliance with the conditions of issuance. Stormwater treatment systems designed using the BMP specific design criteria in the Applicant's Handbook Volume II are presumed to provide reasonable assurance of compliance with state water quality standards. Accordingly, these criteria are often referred to as "presumptive" criteria. A presumptive approach generally allows applicants to provide reasonable assurance that systems will not harm water resources without requiring monitoring or substantial amounts of site-specific information. The presumption is rebuttable, however, if site-specific information

exist that indicate NFWFMD goals and objectives will not be met unless additional or alternative measures are taken.

Alternative BMPs that provide treatment equivalent to “presumptive” BMP systems can be permitted using the Alternative Design provision in Section 4.13 of the NFWFMD Applicant’s [Handbook Volume II](#). However, applicants must demonstrate, with appropriate data, that they provide reasonable assurance the discharges from the proposed BMP design will comply with water quality standards based on information specific to the proposed design.

The requirements established in this Manual for LID serve as “presumptive” design criteria. While the Applicant’s Handbook Volume II does not include most of the LID BMPs in this Manual, the LID BMP design criteria are supported by load reduction effectiveness data allowing them to be permitted as discussed in this section. For the purposes of this manual, BMP effectiveness is based on removal of the average annual nutrient loading (total nitrogen and total phosphorus). It is presumed that systems designed to achieve adequate treatment efficiencies for nutrients will be sufficient to adequately treat other pollutants that could otherwise cause or contribute to water quality violations.

6.4.1. Rain Garden (Bioretention Systems)

A stormwater treatment system incorporating shallow bioretention may be permitted under ERP “presumptive” criteria based on the criteria in the Applicant’s Handbook for online retention systems. Generally, the design criteria for Rain Gardens in this Manual are consistent and compatible with the design criteria for retention systems in Section 5.0 of the NFWFMD’s Applicant’s Handbook Volume II. The minimum Required Treatment Volume (RTV) is the same.

However, the Manual does provide tables to change the RTV to increase the average annual pollutant load reduction to meet the “Net Improvement” performance standard. Additionally, a rain garden includes soils that are conducive to growing plants and infiltrating the RTV in the required time. A rain garden may also include engineered soils, such as BAM, to enhance pollutant removal or prevent nitrate production in coarse, sandy soils.

6.4.2. Swales

A stormwater treatment system incorporating swales may be permitted under ERP “presumptive” criteria based on the criteria in the Applicant’s Handbook for swales. Generally, the design criteria for swales in this Manual are consistent and compatible with the design criteria for Swale Systems in Section 9.0 of the NFWFMD’s Applicant’s Handbook Volume II. If swale blocks are used, then the RTV in this Manual is the same as the RTV in the AH.

However, an updated equation is used for sizing and determining the RTV for conveyance swales in this Manual. This RTV is acceptable to the NFWFMD since the average annual pollutant load reduction, as calculated with the BMPTRAINS model, provides reasonable assurance that the swale will meet the desired performance standard.

6.4.3. Vegetated Natural Buffers

A stormwater treatment system incorporating Vegetated Natural Buffers may be permitted under ERP “presumptive” criteria based on the criteria in Section 11.0 of the NFWFMD’s Applicant’s Handbook Volume II. Generally, the design criteria for VNBs in this Manual are consistent and compatible with the Handbook’s design criteria for VNBs. However, the RTV in this Manual is based on the retention tables in Appendix A. Section 11 uses travel time for a 2 year, 24-hour storm. Additionally, Section 11 allows VNBs to be used on HSG C and D soils by using travel time as a design criterion. The Manual includes recommendations for construction, inspection, and maintenance. This Manual’s RTV is acceptable to the NFWFMD since the average annual

pollutant load reduction, as calculated with the BMPTRAINS model, provides reasonable assurance that the swale will meet the desired performance standard.

6.4.4. Pervious Pavement

Pervious Pavement systems currently are not included in the NFWFMD Applicant's Handbook Volume II. The design criteria in this Manual are updated from those proposed by DEP and the WMDs in 2010. Discussions with NFWFMD staff indicate that Pervious Pavement systems can be approved as a "retention system" in an ERP application using the criteria in this Manual.

6.4.5. Green Roofs with Cisterns

Green Roofs with Cisterns currently are not included in the NFWFMD Applicant's Handbook Volume II. The design criteria in this Manual are updated from those proposed by DEP and the WMDs in 2010. Discussions with NFWFMD staff indicate that Green Roofs with Cisterns can be approved as a "retention system" in an ERP application using the criteria in this Manual.

6.4.6. Rainwater Harvesting Systems

Rainwater Harvesting systems currently are not included in the NFWFMD Applicant's Handbook Volume II. The use of rain barrels for rainwater harvesting is not an acceptable BMP for meeting ERP requirements. However, it is a good way for homeowners to reduce stormwater pollution and potable water use for irrigation. More permanent storage structures that are associated with rain water reuse systems have been permitted. Discussions with NFWFMD staff indicate that rainwater harvesting systems can be approved as a "retention system" in an ERP application using the criteria in this Manual.

6.4.7. Stormwater Harvesting

A stormwater treatment system incorporating Stormwater Harvesting may be permitted under ERP "presumptive" criteria based on the criteria in Section 11.0 of the NFWFMD's Applicant's Handbook Volume II. The design criteria for Stormwater Harvesting in this Manual are consistent and compatible with those in the Applicant's Handbook although the criteria in the Manual are revised and updated. One difference in the design criteria is the Applicant's Handbook criteria require a Littoral Zone. However, given that the harvested stormwater is filtered and reused, discussions with NFWFMD staff indicate that they can approve a stormwater harvesting system using the criteria in this Manual.

6.4.8. Up-Flow Filter Systems

Up-Flow Filters currently are not included in the NFWFMD Applicant's Handbook Volume II. However, Section 6.0 of the AH contains design criteria for underdrain filters used with detention systems. The Up-Flow Filter design criteria in this Manual are supported by extensive effectiveness monitoring thus allowing them to be permitted under Section 4.13, Alternative Design. Discussions with NFWFMD staff indicate that Up-Flow Filter Systems can be approved in an ERP application using the criteria in this Manual.

6.4.9. Managed Aquatic Plant Systems (MAPS)

A stormwater treatment system incorporating Littoral Zones may be permitted under ERP "presumptive" criteria based on the criteria in Section 8.6 of the NFWFMD's Applicant's Handbook Volume II. The design criteria for Littoral Zones in this Manual are consistent and compatible with those in the Applicant's Handbook although the criteria in the Manual are revised and updated. Discussions with NFWFMD staff indicate that Littoral Zones can be approved in an ERP application using the criteria in this Manual. Floating Wetland Mats would need to be permitting under Section 4.13, Alternative Design.

6.4.10. Biofiltration Systems with BAM

Biofiltration systems currently are not included in the NFWFMD Applicant's Handbook Volume II. However, Section 6.0 contains design criteria for underdrain filters used with detention systems that use a sand media for filtration. The Up-Flow Filter design criteria in this Manual are supported by extensive effectiveness monitoring thus allowing them to be permitted under Section 4.13, Alternative Design. Discussions with NFWFMD staff indicate that Biofiltration Systems with BAM can be approved in an ERP application using the criteria in this Manual.

6.4.11. Source Control and Site Planning BMPs

The Source Control and Site Planning BMPs with specific stormwater pollutant load reduction credits typically can't be included in a stormwater system obtaining a NFWFMD Environmental Resource Permit. However, in those cases where a permit is based on Net Improvement and net pollutant loading, some of these BMPs may be allowed to be included in the stormwater treatment train. SP7, Natural Areas Conservation Credit, and SP11, Minimize Directly Connected Impervious Areas, are both easily incorporated into calculating pre- and post-development stormwater volume, especially when the "Harper Methodology" is used since this is based on the %DCIA and the non-DCIA CN. In BMAPs, the FDEP gives a 3% TN and TP load reduction credit if local LDCs require Florida-friendly landscaping and fertilizers. A similar load reduction credit currently is not available in ERP. LID BMP SC7, Rainfall Interceptor Trees, is a new BMP that has not yet been approved by FDEP and the WMDs as additional monitoring data is needed to verify the rainfall volume reduction.

6.5. References

1. Urban Stormwater Management Program, FDEP, Nonpoint Source Management Program. Available on-line at: <http://www.dep.state.fl.us/water/nonpoint/urban1.htm>
2. Environmental Resource Permit Applicant's Handbook Volume II NFWFMD. Available on-line at: <https://www.flrules.org/Gateway/reference.asp?No=Ref-03172>

ESCAMBIA
COUNTY
LOW IMPACT
DESIGN
MANUAL
APPENDICES

APPENDIX A. RAINFALL ZONE 1 RETENTION BMP TREATMENT VOLUMES AND AVERAGE ANNUAL POLLUTANT LOAD REDUCTIONS.

Table A1-1 presents the dry retention treatment depths for an average annual pollutant load reduction of 80 Percent in Rainfall Zone 1.

Table A2-1 consists of a series of tables of different dry retention treatment depths, from 0.25” to 4.00”, as a function of DCIA and non-DCIA Curve Number, with the corresponding average annual pollutant load reduction effectiveness.

Table A1-1. Dry Retention Depths for an Annual Load Reduction Efficiency of 80 Percent in Zone 1.

Panhandle (Zone 1)

NDCIA CN	Percent DCIA																		
	10	15	20	25	30	35	40	45	50	55	60	65	70	75	80	85	90	95	100
30	0.25	0.36	0.45	0.52	0.63	0.71	0.80	0.90	0.99	1.08	1.17	1.27	1.36	1.45	1.55	1.64	1.73	1.83	1.92
35	0.29	0.39	0.46	0.54	0.64	0.72	0.82	0.91	1.00	1.09	1.18	1.27	1.37	1.46	1.55	1.64	1.74	1.83	1.92
40	0.35	0.43	0.49	0.58	0.67	0.75	0.84	0.93	1.02	1.11	1.20	1.29	1.38	1.47	1.56	1.65	1.74	1.83	1.92
45	0.44	0.47	0.54	0.62	0.70	0.78	0.87	0.95	1.04	1.13	1.21	1.30	1.39	1.48	1.57	1.66	1.74	1.83	1.92
50	0.56	0.55	0.60	0.67	0.74	0.82	0.90	0.98	1.06	1.15	1.23	1.32	1.41	1.49	1.58	1.66	1.75	1.83	1.92
55	0.71	0.67	0.69	0.74	0.80	0.87	0.95	1.02	1.10	1.18	1.26	1.34	1.43	1.51	1.59	1.67	1.75	1.84	1.92
60	0.89	0.81	0.81	0.83	0.88	0.94	1.01	1.07	1.15	1.22	1.30	1.37	1.45	1.53	1.60	1.68	1.76	1.84	1.92
65	1.07	0.98	0.95	0.96	0.99	1.03	1.08	1.14	1.21	1.27	1.34	1.41	1.48	1.55	1.62	1.70	1.77	1.85	1.92
70	1.24	1.15	1.11	1.10	1.11	1.14	1.18	1.23	1.28	1.34	1.40	1.46	1.52	1.58	1.65	1.72	1.78	1.85	1.92
75	1.42	1.33	1.29	1.27	1.27	1.28	1.30	1.33	1.37	1.42	1.47	1.52	1.57	1.62	1.68	1.74	1.80	1.86	1.92
80	1.58	1.50	1.46	1.43	1.42	1.43	1.44	1.46	1.49	1.52	1.55	1.59	1.63	1.68	1.72	1.77	1.82	1.87	1.92
85	1.73	1.67	1.63	1.60	1.59	1.58	1.59	1.59	1.61	1.63	1.65	1.68	1.71	1.74	1.77	1.80	1.84	1.88	1.92
90	1.85	1.82	1.79	1.77	1.75	1.74	1.74	1.74	1.74	1.75	1.76	1.77	1.79	1.81	1.83	1.85	1.87	1.90	1.92
95	1.94	1.92	1.91	1.90	1.89	1.88	1.88	1.87	1.87	1.87	1.87	1.88	1.88	1.88	1.89	1.90	1.90	1.91	1.92
98	1.94	1.93	1.93	1.93	1.92	1.92	1.92	1.92	1.92	1.92	1.92	1.91	1.92	1.92	1.92	1.92	1.92	1.92	1.92

Table A2-1. Dry Retention BMP Mean Annual Pollutant Load Reduction for Various Stormwater Treatment Volumes as a Function of DCIA and non-DCIA Curve Number for Meteorological Zone 1.

Mean Annual Mass Removal Efficiencies for 0.25-inches of Retention for Zone 1

NDCIA CN	Percent DCIA																			
	5	10	15	20	25	30	35	40	45	50	55	60	65	70	75	80	85	90	95	100
30	86.2	81.3	73.3	65.5	58.7	53.0	48.3	44.2	40.8	37.9	35.3	33.1	31.1	29.4	27.8	26.4	25.1	24.0	22.9	21.9
35	81.6	78.7	71.7	64.5	58.0	52.5	47.9	44.0	40.6	37.7	35.2	33.0	31.0	29.3	27.8	26.4	25.1	23.9	22.9	21.9
40	76.4	75.5	69.6	63.1	57.1	51.9	47.4	43.6	40.3	37.5	35.0	32.9	30.9	29.2	27.7	26.3	25.1	23.9	22.9	21.9
45	70.7	71.7	67.2	61.4	55.9	51.0	46.8	43.1	40.0	37.2	34.8	32.7	30.8	29.1	27.6	26.3	25.0	23.9	22.9	21.9
50	64.7	67.5	64.2	59.4	54.5	50.0	46.0	42.6	39.5	36.9	34.6	32.5	30.7	29.0	27.5	26.2	25.0	23.9	22.9	21.9
55	58.6	62.8	60.9	57.0	52.7	48.7	45.1	41.8	39.0	36.5	34.2	32.3	30.5	28.9	27.4	26.1	24.9	23.9	22.9	21.9
60	52.8	57.8	57.1	54.2	50.7	47.1	43.9	40.9	38.3	35.9	33.8	31.9	30.2	28.7	27.3	26.0	24.9	23.8	22.8	21.9
65	47.3	52.6	53.0	51.1	48.3	45.3	42.5	39.8	37.4	35.3	33.3	31.5	29.9	28.4	27.1	25.9	24.8	23.8	22.8	21.9
70	42.2	47.3	48.6	47.6	45.6	43.2	40.8	38.5	36.4	34.4	32.6	31.0	29.5	28.1	26.9	25.7	24.7	23.7	22.8	21.9
75	37.8	42.2	43.9	43.7	42.4	40.7	38.8	36.9	35.1	33.4	31.8	30.4	29.0	27.8	26.6	25.5	24.5	23.6	22.7	21.9
80	34.0	37.5	39.1	39.4	38.8	37.7	36.4	34.9	33.5	32.1	30.8	29.5	28.3	27.2	26.2	25.2	24.3	23.5	22.7	21.9
85	30.8	33.1	34.3	34.8	34.7	34.2	33.4	32.5	31.4	30.4	29.4	28.4	27.4	26.5	25.7	24.8	24.1	23.3	22.6	21.9
90	27.9	29.2	29.9	30.3	30.3	30.2	29.8	29.3	28.8	28.2	27.5	26.8	26.2	25.5	24.9	24.2	23.6	23.0	22.5	21.9
95	25.3	25.6	25.8	25.9	26.0	25.9	25.8	25.6	25.4	25.2	24.9	24.6	24.3	24.0	23.6	23.3	23.0	22.6	22.3	21.9
98	23.8	23.8	23.8	23.7	23.7	23.6	23.5	23.4	23.3	23.2	23.1	23.0	22.9	22.8	22.6	22.5	22.4	22.2	22.1	21.9

Mean Annual Mass Removal Efficiencies for 0.50-inches of Retention for Zone 1

NDCIA CN	Percent DCIA																			
	5	10	15	20	25	30	35	40	45	50	55	60	65	70	75	80	85	90	95	100
30	91.8	91.5	88.3	84.0	79.5	75.0	70.7	66.6	62.9	59.6	56.5	53.6	51.1	48.7	46.6	44.6	42.8	41.1	39.6	38.1
35	88.2	89.1	86.6	82.8	78.6	74.3	70.1	66.2	62.6	59.3	56.3	53.5	51.0	48.7	46.5	44.6	42.8	41.1	39.6	38.1
40	84.0	86.3	84.4	81.2	77.4	73.4	69.4	65.7	62.2	59.0	56.0	53.3	50.8	48.5	46.4	44.5	42.7	41.1	39.6	38.1
45	79.6	82.9	81.9	79.3	75.9	72.2	68.5	65.0	61.7	58.6	55.7	53.0	50.6	48.4	46.3	44.4	42.7	41.0	39.5	38.1
50	74.8	79.1	79.0	77.0	74.1	70.8	67.4	64.1	61.0	58.0	55.3	52.7	50.4	48.2	46.2	44.3	42.6	41.0	39.5	38.1
55	70.1	74.9	75.6	74.2	71.9	69.1	66.1	63.0	60.1	57.3	54.7	52.3	50.0	47.9	46.0	44.2	42.5	40.9	39.5	38.1
60	65.5	70.4	71.7	71.1	69.4	67.0	64.4	61.7	59.1	56.5	54.1	51.8	49.6	47.6	45.8	44.0	42.4	40.9	39.5	38.1
65	61.0	65.8	67.5	67.6	66.4	64.7	62.5	60.2	57.8	55.5	53.3	51.1	49.1	47.2	45.5	43.8	42.3	40.8	39.4	38.1
70	56.7	61.1	63.1	63.6	63.1	61.9	60.2	58.3	56.3	54.3	52.3	50.3	48.5	46.8	45.1	43.5	42.1	40.7	39.4	38.1
75	52.7	56.6	58.6	59.3	59.3	58.6	57.5	56.0	54.4	52.7	51.0	49.3	47.7	46.1	44.6	43.2	41.8	40.5	39.3	38.1
80	49.1	52.2	54.1	55.0	55.2	54.9	54.2	53.2	52.1	50.8	49.4	48.0	46.6	45.3	44.0	42.7	41.5	40.3	39.2	38.1
85	46.1	48.3	49.7	50.5	50.8	50.8	50.5	49.9	49.2	48.3	47.3	46.3	45.2	44.2	43.1	42.1	41.0	40.0	39.1	38.1
90	43.5	44.8	45.6	46.1	46.4	46.5	46.4	46.1	45.7	45.2	44.6	44.0	43.3	42.6	41.9	41.1	40.4	39.6	38.9	38.1
95	41.1	41.5	41.8	41.9	42.0	42.1	42.0	41.9	41.8	41.6	41.3	41.1	40.8	40.4	40.1	39.7	39.3	38.9	38.5	38.1
98	39.8	39.8	39.8	39.8	39.8	39.7	39.7	39.6	39.5	39.4	39.3	39.2	39.1	39.0	38.9	38.7	38.6	38.4	38.3	38.1

Mean Annual Mass Removal Efficiencies for 0.75-inches of Retention for Zone 1

NDCIA CN	Percent DCIA																			
	5	10	15	20	25	30	35	40	45	50	55	60	65	70	75	80	85	90	95	100
30	94.0	94.9	93.4	91.0	88.1	85.0	81.8	78.7	75.5	72.6	69.7	67.0	64.5	62.1	59.8	57.7	55.7	53.8	52.1	50.5
35	91.2	93.0	91.9	89.8	87.2	84.2	81.2	78.2	75.2	72.3	69.5	66.8	64.3	62.0	59.7	57.6	55.7	53.8	52.1	50.5
40	88.1	90.5	90.1	88.3	86.0	83.3	80.5	77.6	74.7	71.9	69.2	66.6	64.1	61.8	59.6	57.6	55.6	53.8	52.1	50.5
45	84.5	87.7	87.9	86.5	84.5	82.1	79.5	76.8	74.0	71.4	68.8	66.3	63.9	61.6	59.5	57.5	55.5	53.7	52.0	50.5
50	80.8	84.6	85.2	84.4	82.8	80.7	78.3	75.8	73.3	70.7	68.3	65.9	63.6	61.4	59.3	57.3	55.5	53.7	52.0	50.5
55	77.1	81.1	82.2	81.9	80.7	79.0	76.9	74.6	72.3	70.0	67.6	65.4	63.2	61.1	59.1	57.2	55.3	53.6	52.0	50.5
60	73.2	77.5	79.0	79.1	78.3	76.9	75.2	73.2	71.1	69.0	66.9	64.7	62.7	60.7	58.8	56.9	55.2	53.5	51.9	50.5
65	69.6	73.8	75.4	75.8	75.5	74.5	73.2	71.5	69.7	67.8	65.9	63.9	62.0	60.2	58.4	56.7	55.0	53.4	51.9	50.5
70	66.1	69.9	71.7	72.3	72.3	71.7	70.8	69.5	68.0	66.4	64.7	63.0	61.3	59.6	57.9	56.3	54.8	53.3	51.8	50.5
75	62.7	66.0	67.8	68.6	68.8	68.5	67.9	67.1	65.9	64.7	63.3	61.8	60.3	58.8	57.3	55.9	54.5	53.1	51.7	50.5
80	59.6	62.2	63.8	64.7	65.1	65.1	64.8	64.2	63.4	62.5	61.4	60.3	59.1	57.8	56.6	55.3	54.0	52.8	51.6	50.5
85	56.8	58.7	60.0	60.8	61.2	61.4	61.3	61.0	60.5	59.9	59.1	58.3	57.4	56.5	55.5	54.5	53.5	52.5	51.4	50.5
90	54.5	55.6	56.4	57.0	57.3	57.5	57.5	57.4	57.2	56.8	56.4	55.9	55.4	54.7	54.1	53.4	52.7	51.9	51.2	50.5
95	52.5	52.9	53.2	53.3	53.5	53.6	53.6	53.6	53.5	53.4	53.2	53.0	52.8	52.5	52.2	51.9	51.6	51.2	50.8	50.5
98	51.7	51.7	51.7	51.7	51.7	51.7	51.7	51.6	51.6	51.5	51.4	51.3	51.3	51.2	51.1	51.0	50.8	50.7	50.6	50.5

Mean Annual Mass Removal Efficiencies for 1.00-inches of Retention for Zone 1

NDCIA CN	Percent DCIA																			
	5	10	15	20	25	30	35	40	45	50	55	60	65	70	75	80	85	90	95	100
30	95.3	96.5	95.9	94.4	92.5	90.3	87.9	85.5	83.1	80.6	78.2	75.8	73.6	71.4	69.2	67.2	65.3	63.4	61.6	60.0
35	93.1	94.9	94.6	93.3	91.6	89.5	87.3	85.0	82.7	80.3	77.9	75.6	73.4	71.2	69.1	67.1	65.2	63.4	61.6	60.0
40	90.7	93.0	93.0	92.0	90.5	88.6	86.6	84.4	82.1	79.9	77.6	75.4	73.2	71.1	69.0	67.0	65.2	63.3	61.6	60.0
45	88.0	90.7	91.0	90.5	89.2	87.5	85.6	83.6	81.5	79.3	77.2	75.0	72.9	70.9	68.8	66.9	65.1	63.3	61.6	60.0
50	85.0	88.0	88.8	88.6	87.6	86.2	84.5	82.7	80.7	78.7	76.6	74.6	72.6	70.6	68.6	66.8	65.0	63.2	61.6	60.0
55	81.8	85.3	86.4	86.3	85.7	84.6	83.2	81.5	79.8	77.9	75.9	74.0	72.1	70.2	68.4	66.6	64.8	63.1	61.5	60.0
60	78.7	82.3	83.6	83.9	83.5	82.7	81.5	80.1	78.6	76.9	75.1	73.4	71.6	69.8	68.0	66.3	64.7	63.0	61.5	60.0
65	75.6	79.1	80.6	81.2	81.0	80.5	79.6	78.5	77.2	75.7	74.1	72.5	70.9	69.3	67.6	66.0	64.4	62.9	61.4	60.0
70	72.7	75.9	77.5	78.2	78.3	78.0	77.4	76.5	75.5	74.2	72.9	71.5	70.1	68.6	67.1	65.6	64.2	62.7	61.3	60.0
75	69.9	72.7	74.2	75.0	75.3	75.2	74.8	74.2	73.4	72.5	71.4	70.3	69.1	67.8	66.5	65.1	63.8	62.5	61.2	60.0
80	67.2	69.5	70.8	71.7	72.1	72.1	72.0	71.6	71.1	70.4	69.6	68.7	67.8	66.7	65.6	64.5	63.4	62.2	61.1	60.0
85	64.8	66.5	67.6	68.3	68.7	68.9	68.9	68.7	68.4	68.0	67.5	66.8	66.1	65.4	64.5	63.7	62.8	61.8	60.9	60.0
90	62.7	63.7	64.4	65.0	65.3	65.5	65.6	65.6	65.5	65.2	65.0	64.6	64.2	63.7	63.1	62.6	61.9	61.3	60.6	60.0
95	61.1	61.5	61.8	62.0	62.1	62.2	62.3	62.3	62.3	62.2	62.1	62.0	61.8	61.6	61.4	61.2	60.9	60.6	60.3	60.0
98	60.7	60.7	60.7	60.8	60.8	60.8	60.8	60.8	60.7	60.7	60.7	60.6	60.6	60.5	60.4	60.3	60.3	60.2	60.1	60.0

Mean Annual Mass Removal Efficiencies for 1.25-inches of Retention for Zone 1

NDCIA CN	Percent DCIA																			
	5	10	15	20	25	30	35	40	45	50	55	60	65	70	75	80	85	90	95	100
30	96.1	97.3	97.2	96.3	94.9	93.4	91.6	89.7	87.8	85.8	83.8	81.8	79.9	77.9	76.0	74.2	72.4	70.6	68.9	67.3
35	94.5	96.1	96.2	95.4	94.1	92.7	91.0	89.2	87.4	85.5	83.5	81.6	79.7	77.8	75.9	74.1	72.3	70.6	68.9	67.3
40	92.5	94.5	94.8	94.2	93.2	91.9	90.3	88.6	86.9	85.0	83.2	81.3	79.5	77.6	75.8	74.0	72.3	70.6	68.9	67.3
45	90.4	92.7	93.2	92.8	92.0	90.9	89.4	87.9	86.3	84.5	82.8	81.0	79.2	77.4	75.6	73.9	72.2	70.5	68.9	67.3
50	88.0	90.6	91.3	91.2	90.6	89.7	88.4	87.0	85.5	83.9	82.2	80.5	78.8	77.1	75.4	73.7	72.1	70.4	68.9	67.3
55	85.4	88.2	89.2	89.3	88.9	88.2	87.2	86.0	84.6	83.1	81.6	80.0	78.4	76.7	75.1	73.5	71.9	70.3	68.8	67.3
60	82.7	85.7	86.9	87.2	87.0	86.5	85.7	84.7	83.5	82.2	80.8	79.3	77.8	76.3	74.8	73.2	71.7	70.2	68.8	67.3
65	80.1	83.1	84.4	84.9	84.9	84.5	83.9	83.1	82.1	81.0	79.8	78.5	77.1	75.7	74.3	72.9	71.5	70.1	68.7	67.3
70	77.6	80.3	81.7	82.4	82.5	82.4	81.9	81.3	80.6	79.7	78.6	77.5	76.3	75.1	73.8	72.5	71.2	69.9	68.6	67.3
75	75.2	77.6	79.0	79.7	80.0	79.9	79.7	79.3	78.7	78.0	77.2	76.3	75.3	74.2	73.1	72.0	70.9	69.7	68.5	67.3
80	73.0	74.9	76.1	76.8	77.2	77.3	77.3	77.0	76.6	76.1	75.5	74.8	74.0	73.2	72.3	71.4	70.4	69.4	68.4	67.3
85	70.9	72.3	73.3	73.9	74.3	74.5	74.6	74.5	74.3	73.9	73.5	73.1	72.5	71.9	71.2	70.5	69.8	69.0	68.2	67.3
90	69.2	70.0	70.6	71.1	71.4	71.6	71.7	71.7	71.7	71.5	71.3	71.1	70.7	70.4	70.0	69.5	69.0	68.5	67.9	67.3
95	67.8	68.1	68.4	68.6	68.7	68.9	68.9	69.0	69.0	69.0	68.9	68.9	68.7	68.6	68.5	68.3	68.1	67.8	67.6	67.3
98	67.7	67.7	67.7	67.8	67.8	67.8	67.8	67.8	67.8	67.8	67.8	67.8	67.7	67.7	67.6	67.6	67.5	67.5	67.4	67.3

Mean Annual Mass Removal Efficiencies for 1.50-inches of Retention for Zone 1

NDCIA CN	Percent DCIA																			
	5	10	15	20	25	30	35	40	45	50	55	60	65	70	75	80	85	90	95	100
30	96.8	97.8	98.0	97.5	96.5	95.3	94.0	92.5	90.9	89.3	87.7	86.0	84.3	82.7	81.0	79.3	77.7	76.1	74.6	73.1
35	95.5	96.9	97.1	96.7	95.8	94.7	93.5	92.1	90.6	89.0	87.4	85.8	84.1	82.5	80.9	79.3	77.7	76.1	74.6	73.1
40	93.9	95.6	96.0	95.7	95.0	94.0	92.8	91.5	90.1	88.6	87.1	85.5	83.9	82.3	80.7	79.2	77.6	76.1	74.6	73.1
45	92.1	94.2	94.7	94.5	93.9	93.1	92.0	90.8	89.5	88.1	86.6	85.1	83.6	82.1	80.6	79.0	77.5	76.0	74.5	73.1
50	90.3	92.5	93.1	93.1	92.7	92.0	91.1	90.0	88.8	87.5	86.1	84.7	83.3	81.8	80.3	78.9	77.4	75.9	74.5	73.1
55	88.2	90.5	91.3	91.4	91.2	90.7	89.9	89.0	87.9	86.8	85.5	84.2	82.8	81.5	80.1	78.6	77.2	75.8	74.4	73.1
60	85.9	88.3	89.3	89.6	89.6	89.2	88.6	87.8	86.9	85.9	84.7	83.5	82.3	81.0	79.7	78.4	77.0	75.7	74.4	73.1
65	83.5	86.0	87.2	87.7	87.7	87.5	87.0	86.4	85.7	84.8	83.8	82.8	81.7	80.5	79.3	78.1	76.8	75.6	74.3	73.1
70	81.4	83.7	85.0	85.5	85.7	85.6	85.3	84.8	84.2	83.5	82.7	81.8	80.9	79.9	78.8	77.7	76.5	75.4	74.2	73.1
75	79.4	81.4	82.5	83.2	83.5	83.5	83.3	83.0	82.6	82.1	81.4	80.7	79.9	79.1	78.1	77.2	76.2	75.2	74.1	73.1
80	77.4	79.1	80.1	80.8	81.1	81.2	81.2	81.0	80.8	80.4	79.9	79.4	78.8	78.1	77.3	76.5	75.7	74.9	74.0	73.1
85	75.7	76.9	77.7	78.3	78.6	78.8	78.9	78.9	78.7	78.5	78.2	77.8	77.4	76.9	76.3	75.8	75.1	74.5	73.8	73.1
90	74.2	74.9	75.4	75.9	76.2	76.4	76.5	76.5	76.5	76.4	76.3	76.1	75.8	75.5	75.2	74.8	74.4	74.0	73.6	73.1
95	73.1	73.3	73.6	73.8	73.9	74.0	74.1	74.2	74.2	74.2	74.2	74.2	74.1	74.0	73.9	73.8	73.6	73.5	73.3	73.1
98	73.1	73.1	73.2	73.2	73.3	73.3	73.3	73.3	73.3	73.3	73.3	73.3	73.3	73.3	73.3	73.2	73.2	73.2	73.1	73.1

Mean Annual Mass Removal Efficiencies for 1.75-inches of Retention for Zone 1

NDCIA CN	Percent DCIA																			
	5	10	15	20	25	30	35	40	45	50	55	60	65	70	75	80	85	90	95	100
30	97.3	98.1	98.4	98.2	97.6	96.6	95.6	94.4	93.2	91.8	90.4	89.0	87.6	86.1	84.7	83.3	81.8	80.4	79.0	77.6
35	96.1	97.4	97.7	97.6	97.0	96.1	95.1	94.0	92.8	91.5	90.2	88.8	87.4	86.0	84.6	83.2	81.8	80.4	79.0	77.6
40	94.9	96.4	96.8	96.7	96.2	95.5	94.5	93.5	92.4	91.1	89.9	88.5	87.2	85.8	84.4	83.1	81.7	80.3	78.9	77.6
45	93.5	95.3	95.8	95.7	95.3	94.6	93.8	92.9	91.8	90.6	89.5	88.2	86.9	85.6	84.2	82.9	81.6	80.2	78.9	77.6
50	92.0	93.9	94.5	94.5	94.2	93.7	93.0	92.1	91.2	90.1	89.0	87.8	86.6	85.3	84.0	82.8	81.5	80.2	78.9	77.6
55	90.3	92.3	93.0	93.1	92.9	92.5	92.0	91.2	90.4	89.4	88.4	87.3	86.1	85.0	83.8	82.6	81.3	80.1	78.8	77.6
60	88.4	90.5	91.3	91.5	91.5	91.2	90.8	90.1	89.4	88.6	87.7	86.7	85.6	84.5	83.4	82.3	81.1	80.0	78.8	77.6
65	86.4	88.4	89.4	89.8	89.9	89.7	89.4	88.9	88.3	87.6	86.8	86.0	85.0	84.0	83.0	82.0	80.9	79.8	78.7	77.6
70	84.4	86.4	87.4	88.0	88.1	88.1	87.9	87.5	87.0	86.4	85.8	85.1	84.3	83.4	82.5	81.6	80.6	79.6	78.6	77.6
75	82.6	84.4	85.4	86.0	86.2	86.3	86.2	85.9	85.6	85.1	84.6	84.0	83.4	82.7	81.9	81.1	80.3	79.4	78.5	77.6
80	81.0	82.4	83.3	83.9	84.2	84.3	84.2	84.0	83.7	83.3	82.8	82.4	81.8	81.2	80.6	79.9	79.1	78.4	77.6	77.6
85	79.4	80.5	81.2	81.7	82.0	82.2	82.3	82.3	82.2	82.0	81.8	81.5	81.2	80.8	80.4	79.9	79.3	78.8	78.2	77.6
90	78.1	78.8	79.3	79.6	79.9	80.1	80.2	80.3	80.3	80.2	80.1	80.0	79.8	79.6	79.3	79.0	78.7	78.4	78.0	77.6
95	77.3	77.5	77.8	77.9	78.1	78.2	78.3	78.3	78.4	78.4	78.4	78.4	78.4	78.3	78.2	78.1	78.0	77.9	77.7	77.6
98	77.4	77.5	77.5	77.6	77.6	77.7	77.7	77.7	77.7	77.7	77.7	77.7	77.7	77.7	77.7	77.7	77.7	77.6	77.6	77.6

Mean Annual Mass Removal Efficiencies for 2.00-inches of Retention for Zone 1

NDCIA CN	Percent DCIA																			
	5	10	15	20	25	30	35	40	45	50	55	60	65	70	75	80	85	90	95	100
30	97.9	98.5	98.6	98.6	98.3	97.6	96.7	95.8	94.8	93.7	92.5	91.3	90.0	88.8	87.5	86.2	85.0	83.7	82.4	81.2
35	96.7	97.8	98.1	98.1	97.8	97.1	96.3	95.4	94.4	93.4	92.2	91.1	89.9	88.7	87.4	86.2	84.9	83.7	82.4	81.2
40	95.6	97.0	97.5	97.4	97.1	96.6	95.8	94.9	94.0	93.0	91.9	90.8	89.7	88.5	87.3	86.0	84.8	83.6	82.4	81.2
45	94.5	96.1	96.6	96.6	96.3	95.8	95.2	94.4	93.5	92.6	91.6	90.5	89.4	88.3	87.1	85.9	84.7	83.6	82.4	81.2
50	93.3	95.0	95.5	95.6	95.4	94.9	94.4	93.7	93.0	92.1	91.1	90.1	89.1	88.0	86.9	85.8	84.6	83.5	82.3	81.2
55	91.9	93.7	94.3	94.4	94.2	93.9	93.5	92.9	92.2	91.4	90.6	89.6	88.7	87.7	86.6	85.6	84.5	83.4	82.3	81.2
60	90.4	92.1	92.8	93.0	93.0	92.8	92.4	91.9	91.3	90.6	89.9	89.1	88.2	87.3	86.3	85.3	84.3	83.3	82.2	81.2
65	88.7	90.4	91.2	91.5	91.6	91.5	91.2	90.8	90.3	89.8	89.1	88.4	87.6	86.8	85.9	85.0	84.1	83.1	82.2	81.2
70	87.0	88.6	89.4	89.9	90.1	90.1	89.9	89.6	89.2	88.7	88.2	87.6	86.9	86.2	85.4	84.6	83.8	83.0	82.1	81.2
75	85.3	86.8	87.7	88.2	88.4	88.5	88.4	88.2	87.9	87.6	87.1	86.7	86.1	85.5	84.9	84.2	83.5	82.8	82.0	81.2
80	83.8	85.1	85.8	86.3	86.7	86.8	86.8	86.7	86.5	86.3	86.0	85.6	85.2	84.7	84.2	83.7	83.1	82.5	81.9	81.2
85	82.5	83.4	84.0	84.5	84.8	85.0	85.0	85.0	84.9	84.8	84.6	84.4	84.1	83.8	83.4	83.1	82.6	82.2	81.7	81.2
90	81.4	81.9	82.4	82.7	82.9	83.1	83.2	83.3	83.3	83.3	83.2	83.1	82.9	82.8	82.6	82.3	82.1	81.8	81.5	81.2
95	80.7	80.9	81.1	81.2	81.4	81.5	81.6	81.6	81.7	81.7	81.7	81.7	81.7	81.7	81.6	81.6	81.5	81.4	81.3	81.2
98	80.9	80.9	81.0	81.0	81.1	81.1	81.1	81.2	81.2	81.2	81.2	81.2	81.2	81.2	81.2	81.2	81.2	81.2	81.2	81.2

Mean Annual Mass Removal Efficiencies for 2.25-inches of Retention for Zone 1

NDCIA CN	Percent DCIA																			
	5	10	15	20	25	30	35	40	45	50	55	60	65	70	75	80	85	90	95	100
30	98.4	98.8	98.9	98.9	98.7	98.2	97.6	96.8	95.9	95.0	94.0	93.0	91.9	90.8	89.7	88.6	87.5	86.3	85.2	84.1
35	97.2	98.1	98.4	98.5	98.3	97.9	97.2	96.5	95.6	94.7	93.8	92.8	91.8	90.7	89.6	88.5	87.4	86.3	85.2	84.1
40	96.2	97.4	97.8	97.9	97.8	97.3	96.8	96.1	95.3	94.4	93.5	92.6	91.6	90.5	89.5	88.4	87.3	86.2	85.1	84.1
45	95.3	96.7	97.2	97.3	97.1	96.7	96.2	95.5	94.8	94.0	93.2	92.3	91.3	90.3	89.3	88.3	87.2	86.2	85.1	84.1
50	94.3	95.8	96.3	96.5	96.3	95.9	95.5	94.9	94.3	93.6	92.8	91.9	91.0	90.1	89.1	88.1	87.1	86.1	85.1	84.1
55	93.2	94.8	95.3	95.4	95.3	95.0	94.6	94.2	93.6	93.0	92.3	91.5	90.6	89.8	88.9	87.9	87.0	86.0	85.0	84.1
60	92.0	93.5	94.1	94.3	94.2	94.0	93.7	93.3	92.8	92.3	91.6	90.9	90.2	89.4	88.6	87.7	86.8	85.9	85.0	84.1
65	90.6	92.0	92.7	92.9	93.0	92.9	92.7	92.4	92.0	91.5	90.9	90.3	89.7	89.0	88.2	87.4	86.6	85.8	84.9	84.1
70	89.1	90.4	91.1	91.5	91.6	91.6	91.5	91.3	91.0	90.5	90.1	89.6	89.0	88.4	87.8	87.1	86.4	85.6	84.8	84.1
75	87.6	88.8	89.5	90.0	90.2	90.3	90.2	90.1	89.8	89.5	89.2	88.8	88.3	87.8	87.3	86.7	86.1	85.4	84.7	84.1
80	86.2	87.2	87.9	88.4	88.6	88.8	88.8	88.7	88.6	88.4	88.1	87.8	87.5	87.1	86.7	86.2	85.7	85.2	84.6	84.1
85	85.0	85.8	86.4	86.8	87.0	87.2	87.3	87.3	87.2	87.1	86.9	86.8	86.5	86.3	86.0	85.6	85.3	84.9	84.5	84.1
90	84.0	84.5	84.9	85.2	85.4	85.6	85.7	85.7	85.7	85.7	85.7	85.6	85.5	85.4	85.2	85.0	84.8	84.6	84.3	84.1
95	83.4	83.6	83.8	84.0	84.1	84.2	84.3	84.3	84.4	84.4	84.4	84.4	84.4	84.4	84.4	84.3	84.3	84.2	84.1	84.1
98	83.7	83.7	83.8	83.8	83.9	83.9	83.9	84.0	84.0	84.0	84.0	84.0	84.0	84.1	84.1	84.1	84.1	84.1	84.1	84.1

Mean Annual Mass Removal Efficiencies for 2.50-inches of Retention for Zone 1

NDCIA CN	Percent DCIA																			
	5	10	15	20	25	30	35	40	45	50	55	60	65	70	75	80	85	90	95	100
30	98.7	99.1	99.1	99.1	99.0	98.7	98.2	97.6	96.8	96.1	95.2	94.3	93.4	92.5	91.5	90.5	89.5	88.5	87.4	86.4
35	97.7	98.4	98.6	98.7	98.6	98.4	97.9	97.3	96.6	95.8	95.0	94.2	93.3	92.3	91.4	90.4	89.4	88.4	87.4	86.4
40	96.7	97.8	98.2	98.3	98.2	98.0	97.5	96.9	96.3	95.5	94.8	93.9	93.1	92.2	91.3	90.3	89.3	88.4	87.4	86.4
45	95.9	97.2	97.6	97.8	97.7	97.4	97.0	96.4	95.8	95.2	94.4	93.7	92.8	92.0	91.1	90.2	89.3	88.3	87.4	86.4
50	95.1	96.5	97.0	97.1	97.0	96.7	96.3	95.9	95.3	94.7	94.1	93.3	92.6	91.7	90.9	90.0	89.2	88.2	87.3	86.4
55	94.3	95.6	96.1	96.3	96.2	95.9	95.6	95.2	94.7	94.2	93.6	92.9	92.2	91.5	90.7	89.9	89.0	88.2	87.3	86.4
60	93.3	94.6	95.1	95.3	95.2	95.0	94.8	94.4	94.0	93.6	93.0	92.4	91.8	91.1	90.4	89.6	88.9	88.1	87.2	86.4
65	92.2	93.4	93.9	94.1	94.1	94.0	93.8	93.6	93.2	92.9	92.4	91.9	91.3	90.7	90.0	89.4	88.7	87.9	87.2	86.4
70	90.8	91.9	92.5	92.8	92.9	92.9	92.8	92.6	92.4	92.0	91.6	91.2	90.7	90.2	89.6	89.1	88.4	87.8	87.1	86.4
75	89.5	90.5	91.1	91.5	91.6	91.7	91.7	91.6	91.4	91.1	90.8	90.4	90.1	89.6	89.2	88.7	88.1	87.6	87.0	86.4
80	88.2	89.1	89.7	90.1	90.3	90.4	90.4	90.4	90.3	90.1	89.9	89.6	89.3	89.0	88.6	88.2	87.8	87.4	86.9	86.4
85	87.1	87.8	88.3	88.6	88.9	89.0	89.1	89.1	89.0	89.0	88.8	88.7	88.5	88.3	88.0	87.7	87.4	87.1	86.8	86.4
90	86.3	86.7	87.0	87.3	87.5	87.6	87.7	87.8	87.8	87.8	87.7	87.7	87.6	87.5	87.3	87.2	87.0	86.8	86.6	86.4
95	85.8	85.9	86.1	86.2	86.3	86.4	86.5	86.6	86.6	86.6	86.7	86.7	86.7	86.7	86.6	86.6	86.6	86.5	86.5	86.4
98	86.0	86.1	86.1	86.2	86.2	86.2	86.3	86.3	86.3	86.3	86.3	86.3	86.4	86.4	86.4	86.4	86.4	86.4	86.4	86.4

Mean Annual Mass Removal Efficiencies for 2.75-inches of Retention for Zone 1

NDCIA CN	Percent DCIA																			
	5	10	15	20	25	30	35	40	45	50	55	60	65	70	75	80	85	90	95	100
30	98.9	99.3	99.3	99.3	99.2	99.0	98.6	98.2	97.5	96.9	96.2	95.4	94.6	93.8	92.9	92.0	91.1	90.2	89.3	88.3
35	98.2	98.7	98.8	98.9	98.9	98.7	98.4	97.9	97.3	96.7	96.0	95.2	94.5	93.6	92.8	91.9	91.1	90.2	89.2	88.3
40	97.2	98.1	98.4	98.5	98.5	98.4	98.0	97.6	97.0	96.4	95.7	95.0	94.3	93.5	92.7	91.8	91.0	90.1	89.2	88.3
45	96.4	97.5	97.9	98.1	98.1	97.9	97.6	97.1	96.6	96.1	95.4	94.8	94.1	93.3	92.5	91.7	90.9	90.1	89.2	88.3
50	95.8	97.0	97.4	97.6	97.6	97.4	97.0	96.6	96.2	95.6	95.1	94.5	93.8	93.1	92.4	91.6	90.8	90.0	89.2	88.3
55	95.1	96.3	96.8	96.9	96.9	96.7	96.4	96.0	95.6	95.1	94.6	94.1	93.5	92.8	92.1	91.4	90.7	89.9	89.1	88.3
60	94.4	95.5	95.9	96.1	96.0	95.9	95.7	95.3	95.0	94.6	94.1	93.6	93.1	92.5	91.9	91.2	90.5	89.8	89.1	88.3
65	93.4	94.5	94.9	95.1	95.1	95.0	94.8	94.6	94.3	93.9	93.6	93.1	92.6	92.1	91.5	90.9	90.3	89.7	89.0	88.3
70	92.3	93.2	93.7	93.9	94.0	94.0	93.9	93.7	93.5	93.2	92.9	92.5	92.1	91.7	91.2	90.7	90.1	89.5	88.9	88.3
75	91.0	91.9	92.4	92.7	92.9	92.9	92.9	92.8	92.6	92.4	92.2	91.9	91.5	91.1	90.7	90.3	89.9	89.4	88.9	88.3
80	89.9	90.6	91.1	91.5	91.7	91.8	91.8	91.7	91.5	91.3	91.1	90.9	90.6	90.3	89.9	89.6	89.2	88.8	88.3	88.3
85	88.9	89.5	89.9	90.2	90.4	90.5	90.6	90.6	90.6	90.5	90.4	90.3	90.1	89.9	89.7	89.5	89.2	89.0	88.7	88.3
90	88.1	88.5	88.8	89.0	89.2	89.3	89.4	89.4	89.5	89.5	89.4	89.4	89.3	89.2	89.1	89.0	88.9	88.7	88.5	88.3
95	87.7	87.8	88.0	88.1	88.2	88.3	88.4	88.4	88.5	88.5	88.5	88.5	88.5	88.5	88.5	88.5	88.5	88.4	88.4	88.3
98	87.9	88.0	88.0	88.1	88.1	88.1	88.2	88.2	88.2	88.2	88.3	88.3	88.3	88.3	88.3	88.3	88.3	88.3	88.3	88.3

Mean Annual Mass Removal Efficiencies for 3.00-inches of Retention for Zone 1

NDCIA CN	Percent DCIA																			
	5	10	15	20	25	30	35	40	45	50	55	60	65	70	75	80	85	90	95	100
30	99.1	99.4	99.5	99.4	99.3	99.2	99.0	98.6	98.1	97.5	96.9	96.2	95.5	94.8	94.1	93.3	92.4	91.6	90.8	89.9
35	98.6	99.0	99.1	99.1	99.1	99.0	98.7	98.4	97.9	97.3	96.7	96.1	95.4	94.7	94.0	93.2	92.4	91.6	90.8	89.9
40	97.7	98.4	98.6	98.7	98.7	98.7	98.5	98.1	97.6	97.1	96.5	95.9	95.2	94.6	93.8	93.1	92.3	91.5	90.8	89.9
45	96.9	97.8	98.2	98.4	98.4	98.3	98.1	97.7	97.3	96.8	96.2	95.7	95.0	94.4	93.7	93.0	92.2	91.5	90.7	89.9
50	96.3	97.3	97.8	98.0	98.0	97.9	97.6	97.2	96.9	96.4	95.9	95.4	94.8	94.2	93.5	92.9	92.2	91.4	90.7	89.9
55	95.7	96.8	97.3	97.4	97.4	97.3	97.0	96.7	96.4	96.0	95.5	95.0	94.5	93.9	93.3	92.7	92.0	91.4	90.7	89.9
60	95.2	96.2	96.6	96.8	96.7	96.6	96.4	96.1	95.8	95.4	95.0	94.6	94.1	93.6	93.1	92.5	91.9	91.3	90.6	89.9
65	94.5	95.3	95.8	95.9	95.9	95.8	95.7	95.4	95.2	94.9	94.5	94.1	93.7	93.3	92.8	92.3	91.7	91.1	90.6	89.9
70	93.5	94.3	94.7	94.9	95.0	94.9	94.8	94.7	94.5	94.2	93.9	93.6	93.3	92.9	92.4	92.0	91.5	91.0	90.5	89.9
75	92.4	93.2	93.6	93.8	93.9	93.9	93.9	93.8	93.7	93.5	93.3	93.0	92.7	92.4	92.1	91.7	91.3	90.9	90.4	89.9
80	91.3	92.0	92.4	92.6	92.8	92.9	92.9	92.9	92.8	92.7	92.6	92.4	92.1	91.9	91.6	91.3	91.0	90.7	90.3	89.9
85	90.4	90.9	91.3	91.5	91.7	91.8	91.9	91.9	91.9	91.8	91.7	91.6	91.5	91.3	91.1	90.9	90.7	90.5	90.2	89.9
90	89.7	90.0	90.3	90.5	90.6	90.8	90.8	90.9	90.9	90.9	90.9	90.8	90.8	90.7	90.6	90.5	90.4	90.2	90.1	89.9
95	89.3	89.4	89.6	89.7	89.8	89.8	89.9	90.0	90.0	90.0	90.1	90.1	90.1	90.1	90.1	90.1	90.0	90.0	90.0	89.9
98	89.6	89.6	89.6	89.7	89.7	89.7	89.8	89.8	89.8	89.8	89.9	89.9	89.9	89.9	89.9	89.9	89.9	89.9	89.9	89.9

Mean Annual Mass Removal Efficiencies for 3.25-inches of Retention for Zone 1

NDCIA CN	Percent DCIA																				
	5	10	15	20	25	30	35	40	45	50	55	60	65	70	75	80	85	90	95	100	
30	99.3	99.5	99.6	99.5	99.5	99.4	99.2	98.9	98.5	98.1	97.5	96.9	96.3	95.7	95.0	94.3	93.6	92.8	92.1	91.3	
35	98.8	99.2	99.3	99.2	99.2	99.1	99.0	98.7	98.3	97.9	97.3	96.8	96.2	95.6	94.9	94.2	93.5	92.8	92.0	91.3	
40	98.2	98.7	98.8	98.9	98.9	98.9	98.7	98.5	98.1	97.7	97.2	96.6	96.0	95.4	94.8	94.1	93.5	92.7	92.0	91.3	
45	97.4	98.1	98.5	98.6	98.6	98.6	98.4	98.2	97.8	97.4	96.9	96.4	95.8	95.3	94.7	94.0	93.4	92.7	92.0	91.3	
50	96.7	97.7	98.1	98.2	98.3	98.2	98.1	97.8	97.4	97.0	96.6	96.1	95.6	95.1	94.5	93.9	93.3	92.6	92.0	91.3	
55	96.2	97.2	97.6	97.8	97.9	97.8	97.6	97.3	97.0	96.6	96.2	95.8	95.4	95.0	94.8	94.3	93.8	93.2	92.6	91.9	91.3
60	95.8	96.7	97.1	97.3	97.3	97.2	97.0	96.8	96.5	96.2	95.8	95.4	95.0	94.6	94.6	94.1	93.6	93.0	92.5	91.9	91.3
65	95.3	96.1	96.5	96.6	96.6	96.5	96.3	96.2	95.9	95.6	95.3	95.0	94.6	94.2	93.8	93.4	92.9	92.4	91.8	91.3	
70	94.5	95.3	95.6	95.7	95.7	95.7	95.6	95.5	95.3	95.1	94.8	94.5	94.2	93.9	93.5	93.1	92.7	92.2	91.8	91.3	
75	93.6	94.2	94.5	94.7	94.8	94.8	94.8	94.7	94.6	94.4	94.2	94.0	93.8	93.5	93.2	92.8	92.5	92.1	91.7	91.3	
80	92.6	93.1	93.5	93.7	93.8	93.9	93.9	93.9	93.8	93.7	93.6	93.4	93.2	93.0	92.8	92.5	92.2	91.9	91.6	91.3	
85	91.7	92.1	92.4	92.6	92.8	92.9	93.0	93.0	93.0	92.9	92.9	92.8	92.6	92.5	92.3	92.2	92.0	91.8	91.5	91.3	
90	91.0	91.3	91.6	91.7	91.9	92.0	92.0	92.1	92.1	92.1	92.1	92.1	92.0	91.9	91.9	91.8	91.7	91.6	91.4	91.3	
95	90.7	90.8	91.0	91.0	91.1	91.2	91.2	91.3	91.3	91.4	91.4	91.4	91.4	91.4	91.4	91.4	91.4	91.4	91.3	91.3	
98	90.9	91.0	91.0	91.0	91.1	91.1	91.1	91.1	91.2	91.2	91.2	91.2	91.2	91.2	91.3	91.3	91.3	91.3	91.3	91.3	

Mean Annual Mass Removal Efficiencies for 3.50-inches of Retention for Zone 1

NDCIA CN	Percent DCIA																			
	5	10	15	20	25	30	35	40	45	50	55	60	65	70	75	80	85	90	95	100
30	99.4	99.6	99.6	99.6	99.6	99.5	99.4	99.2	98.8	98.4	98.0	97.5	97.0	96.4	95.8	95.2	94.5	93.8	93.1	92.4
35	99.0	99.3	99.4	99.4	99.4	99.3	99.2	99.0	98.7	98.3	97.9	97.4	96.8	96.3	95.7	95.1	94.5	93.8	93.1	92.4
40	98.5	98.9	99.1	99.1	99.1	99.1	98.9	98.8	98.5	98.1	97.7	97.2	96.7	96.2	95.6	95.0	94.4	93.8	93.1	92.4
45	97.8	98.4	98.7	98.8	98.8	98.8	98.7	98.5	98.2	97.9	97.4	97.0	96.5	96.0	95.5	94.9	94.3	93.7	93.1	92.4
50	97.2	98.0	98.3	98.5	98.5	98.5	98.4	98.2	97.9	97.5	97.2	96.8	96.3	95.8	95.3	94.8	94.2	93.7	93.1	92.4
55	96.7	97.5	97.9	98.1	98.2	98.1	98.0	97.8	97.5	97.2	96.8	96.5	96.0	95.6	95.1	94.7	94.1	93.6	93.0	92.4
60	96.3	97.1	97.5	97.7	97.7	97.7	97.5	97.3	97.1	96.8	96.5	96.1	95.7	95.3	94.9	94.5	94.0	93.5	93.0	92.4
65	95.9	96.6	97.0	97.2	97.2	97.1	96.9	96.8	96.6	96.3	96.0	95.7	95.4	95.1	94.7	94.3	93.9	93.4	92.9	92.4
70	95.4	96.0	96.3	96.4	96.4	96.4	96.3	96.1	96.0	95.8	95.5	95.3	95.0	94.7	94.4	94.1	93.7	93.3	92.9	92.4
75	94.6	95.1	95.4	95.5	95.6	95.6	95.5	95.4	95.3	95.2	95.0	94.8	94.6	94.4	94.1	93.8	93.5	93.2	92.8	92.4
80	93.7	94.1	94.4	94.6	94.7	94.7	94.7	94.7	94.6	94.5	94.4	94.3	94.1	93.9	93.7	93.5	93.3	93.0	92.7	92.4
85	92.9	93.2	93.5	93.6	93.8	93.8	93.9	93.9	93.9	93.8	93.8	93.7	93.6	93.5	93.4	93.2	93.0	92.8	92.6	92.4
90	92.2	92.4	92.6	92.8	92.9	93.0	93.1	93.1	93.1	93.1	93.1	93.1	93.1	93.0	92.9	92.8	92.8	92.7	92.5	92.4
95	91.9	92.0	92.1	92.2	92.3	92.3	92.4	92.4	92.5	92.5	92.5	92.5	92.5	92.5	92.5	92.5	92.5	92.5	92.5	92.4
98	92.1	92.1	92.2	92.2	92.2	92.2	92.3	92.3	92.3	92.3	92.3	92.4	92.4	92.4	92.4	92.4	92.4	92.4	92.4	92.4

Mean Annual Mass Removal Efficiencies for 3.75-inches of Retention for Zone 1

NDCIA CN	Percent DCIA																			
	5	10	15	20	25	30	35	40	45	50	55	60	65	70	75	80	85	90	95	100
30	99.6	99.7	99.7	99.7	99.7	99.6	99.5	99.4	99.1	98.8	98.4	98.0	97.5	97.0	96.4	95.9	95.3	94.7	94.1	93.4
35	99.2	99.4	99.5	99.5	99.5	99.4	99.3	99.2	99.0	98.6	98.3	97.8	97.4	96.9	96.4	95.8	95.2	94.6	94.0	93.4
40	98.8	99.1	99.2	99.3	99.2	99.2	99.1	99.0	98.8	98.5	98.1	97.7	97.2	96.8	96.3	95.7	95.2	94.6	94.0	93.4
45	98.2	98.7	98.9	99.0	99.0	99.0	98.9	98.8	98.6	98.3	97.9	97.5	97.1	96.6	96.1	95.6	95.1	94.6	94.0	93.4
50	97.6	98.2	98.5	98.7	98.7	98.7	98.6	98.5	98.3	98.0	97.7	97.3	96.9	96.5	96.0	95.5	95.0	94.5	94.0	93.4
55	97.1	97.9	98.2	98.4	98.4	98.4	98.3	98.2	97.9	97.7	97.4	97.0	96.6	96.3	95.8	95.4	94.9	94.5	93.9	93.4
60	96.7	97.5	97.8	98.0	98.1	98.1	98.0	97.8	97.5	97.3	97.0	96.7	96.4	96.0	95.6	95.2	94.8	94.4	93.9	93.4
65	96.4	97.1	97.4	97.6	97.6	97.6	97.4	97.3	97.1	96.9	96.6	96.4	96.1	95.7	95.4	95.1	94.7	94.3	93.9	93.4
70	96.0	96.6	96.9	97.0	97.0	97.0	96.9	96.7	96.6	96.4	96.2	96.0	95.7	95.4	95.2	94.9	94.5	94.2	93.8	93.4
75	95.5	95.9	96.1	96.2	96.3	96.3	96.2	96.1	96.0	95.9	95.7	95.5	95.3	95.1	94.9	94.6	94.4	94.1	93.7	93.4
80	94.7	95.0	95.2	95.4	95.5	95.5	95.5	95.4	95.4	95.3	95.2	95.0	94.9	94.7	94.6	94.4	94.2	93.9	93.7	93.4
85	93.8	94.1	94.4	94.5	94.6	94.7	94.7	94.7	94.7	94.7	94.6	94.5	94.4	94.3	94.2	94.1	93.9	93.8	93.6	93.4
90	93.2	93.4	93.6	93.7	93.8	93.9	93.9	94.0	94.0	94.0	94.0	93.9	93.9	93.9	93.8	93.8	93.7	93.6	93.5	93.4
95	92.9	93.0	93.1	93.2	93.2	93.3	93.3	93.4	93.4	93.4	93.4	93.5	93.5	93.5	93.5	93.5	93.5	93.5	93.4	93.4
98	93.1	93.1	93.2	93.2	93.2	93.2	93.3	93.3	93.3	93.3	93.3	93.3	93.4	93.4	93.4	93.4	93.4	93.4	93.4	93.4

Mean Annual Mass Removal Efficiencies for 4.00-inches of Retention for Zone 1

NDCIA CN	Percent DCIA																			
	5	10	15	20	25	30	35	40	45	50	55	60	65	70	75	80	85	90	95	100
30	99.6	99.7	99.8	99.8	99.7	99.7	99.6	99.5	99.3	99.0	98.7	98.3	97.9	97.5	97.0	96.5	95.9	95.4	94.8	94.3
35	99.3	99.5	99.6	99.6	99.6	99.5	99.5	99.3	99.2	98.9	98.6	98.2	97.8	97.4	96.9	96.4	95.9	95.4	94.8	94.3
40	99.0	99.3	99.4	99.4	99.4	99.3	99.3	99.2	99.0	98.8	98.5	98.1	97.7	97.3	96.8	96.3	95.8	95.3	94.8	94.3
45	98.5	98.9	99.1	99.1	99.1	99.1	99.1	99.0	98.8	98.6	98.3	97.9	97.6	97.2	96.7	96.3	95.8	95.3	94.8	94.3
50	98.0	98.5	98.7	98.9	98.9	98.9	98.8	98.7	98.6	98.3	98.1	97.7	97.4	97.0	96.6	96.2	95.7	95.2	94.8	94.3
55	97.5	98.1	98.4	98.6	98.6	98.6	98.6	98.5	98.3	98.1	97.8	97.5	97.1	96.8	96.4	96.0	95.6	95.2	94.7	94.3
60	97.1	97.8	98.1	98.3	98.3	98.3	98.3	98.1	98.0	97.7	97.5	97.2	96.9	96.6	96.3	95.9	95.5	95.1	94.7	94.3
65	96.8	97.4	97.8	97.9	98.0	98.0	97.9	97.7	97.5	97.3	97.1	96.9	96.6	96.3	96.0	95.7	95.4	95.0	94.7	94.3
70	96.5	97.1	97.3	97.5	97.5	97.5	97.4	97.2	97.1	96.9	96.7	96.5	96.3	96.1	95.8	95.5	95.2	94.9	94.6	94.3
75	96.1	96.5	96.7	96.8	96.8	96.8	96.8	96.7	96.6	96.4	96.3	96.1	96.0	95.8	95.5	95.3	95.1	94.8	94.5	94.3
80	95.5	95.8	95.9	96.1	96.1	96.1	96.1	96.1	96.0	95.9	95.8	95.7	95.6	95.4	95.3	95.1	94.9	94.7	94.5	94.3
85	94.7	95.0	95.1	95.3	95.3	95.4	95.4	95.4	95.4	95.4	95.3	95.2	95.1	95.0	94.9	94.8	94.7	94.6	94.4	94.3
90	94.1	94.3	94.4	94.5	94.6	94.7	94.7	94.8	94.8	94.8	94.8	94.7	94.7	94.7	94.6	94.6	94.5	94.4	94.3	94.3
95	93.8	93.9	94.0	94.0	94.1	94.1	94.2	94.2	94.2	94.3	94.3	94.3	94.3	94.3	94.3	94.3	94.3	94.3	94.3	94.3
98	94.0	94.0	94.0	94.0	94.1	94.1	94.1	94.1	94.1	94.2	94.2	94.2	94.2	94.2	94.2	94.2	94.2	94.2	94.2	94.3

APPENDIX B. METHODOLOGIES

The methodologies in this Appendix are intended to aid applicants in designing Low Impact Design BMPs to meet the design and performance criteria of this Manual. These methodologies are by no means the only acceptable method for designing stormwater management systems. Applicants proposing to use alternative methodologies are encouraged to consult with County or NFWMD staff in a pre-application conference.

B.1. Methodologies, Recovery Analysis, and Soil Testing for Retention Systems

B.1.1. Description

“Retention systems” are a family of Best Management Practices (BMPs) designed to store a defined quantity of runoff, allowing it to percolate through vegetation and permeable soils into the shallow ground water aquifer, evaporate, or evapotranspire. Stormwater retention works best using a variety of BMPs throughout the project site. Examples of common retention BMPs include (but are not limited to):

- Retention basins which are constructed or natural depression areas where the basin bottom is graded as flat as possible and turf, seed & mulch (or other equivalent materials) are established to promote infiltration and stabilize the basin slopes. These retention systems are discussed in greater detail in [Section 5.3](#) of this Manual.
- Underground Exfiltration Trenches that are discussed in greater detail in [Section 5.4](#) of this Manual.
- Underground Retention Systems that are discussed in greater detail in [Section 5.5](#) of this Manual.
- Rain gardens are discussed in greater detail in [Section 5.6](#) of this Manual.
- Vegetated treatment swales with or without swale blocks that are discussed in greater detail in [Section 5.7](#) of this Manual.
- Vegetated Natural Buffers that are discussed in greater detail in [Section 5.8](#) of this Manual.
- Pervious pavement with perimeter edge constraints that are discussed in greater detail in [Section 5.9](#) of this Manual.

Each of the BMPs listed above have their individual advantages and disadvantages. Cross-sectional diagrams for each of these BMPs are provided in their respective sections of the *Manual* as noted above. It is not the intent of this section to cover all potential designs. Professional judgment must be used in the design and review of proposed retention BMPs.

The soil’s saturated hydraulic conductivity, depth to the Seasonal High Ground Water Table ([SHGWT](#)) and depth to the confining unit (i.e., clay, hardpan, etc.) must be such that the retention system can percolate the Required Treatment Volume (RTV) within a specified time following a storm event. After drawdown has been completed, retention BMPs do not hold any water, thus the systems are normally “dry.” Unlike detention BMPs, the RTV for retention systems is not discharged to surface waters.

Retention systems provide excellent removal of most stormwater pollutants. Substantial amounts of suspended solids, oxygen demanding materials, heavy metals, bacteria, some varieties of pesticides and nutrients such as phosphorus may be removed as runoff percolates through the soil profile.

Besides pollution control, retention systems can be used to promote the recharge of ground water, to prevent saltwater intrusion in coastal areas and maintain ground water levels in aquifer recharge areas. Retention systems can also be used to help meet the runoff volume criteria for systems that discharge to closed basins or land-locked lakes. However, the use of retention systems are not appropriate if they contribute to a violation of Minimum Flows or Levels in the receiving waters, or if they adversely impact wetlands by hydrologic alteration.

B.1.2. Required Treatment Volume (RTV)

The RTV necessary to achieve the required treatment efficiency shall be routed to the retention BMP and percolated into the ground. The RTV and other design criteria for each type of retention BMP is specified in the section of the Manual for that particular BMP.

B.1.3. Recovery Time of the RTV

All retention systems must provide the capacity for the RTV of stormwater to recover to the bottom of the system within 72 hours following a storm event, assuming an average Antecedent Runoff Condition (ARC II). The locations of the RTV (and its corresponding bottom) are shown in the supporting graphic figures of the various BMP Sections noted above. For some retention BMPs, a safety factor of two (2.0) must be used in the recovery analysis of the RTV. Two possible ways to apply this safety factor are:

- Reducing the design saturated hydraulic conductivity rates by half; or
- Designing for the required RTV drawdown to occur within half of the required drawdown time.
- The safety factor of two (2.0) is based on the high probability of:
 - Soil compaction during clearing and grubbing operations,
 - Improper construction techniques that result in additional soil compaction under the retention BMP,
 - Inadequate long term maintenance of the retention BMP, and
 - Geologic variations and uncertainties in obtaining the soil test parameters for the recovery / mounding analysis (noted in subsequent sections below). These variations and uncertainties are especially suspect for larger retention BMPs.

In retention systems, the RTV recovers (is drawn down or dissipated) by natural soil infiltration into the ground water table, evaporation, or evapotranspiration. The opposite is true for underdrain effluent detention systems, which rely on artificial recovery methods such as underground perforated drainage pipes.

Antecedent Runoff Condition (ARC), formally known as Antecedent Moisture Condition (AMC), refers to the amount of moisture and storage in the soil profile prior to a storm event. Antecedent soil moisture is an indicator of wetness and availability of soil to infiltrate water. The ARC can vary from dry to saturated, depending on the amount of rainfall received prior to a given point in time. Therefore, "average ARC" (ARC II) means the soil is neither dry nor saturated, but at an average moisture condition at the beginning of a storm event when calculating recovery time for retention systems.

B.1.4. Infiltration Processes

When stormwater runoff enters the retention BMP, standing water begins to infiltrate. This water percolates into the soil in two distinct stages, either vertically (Stage One) through the BMP bottom (unsaturated flow), or horizontally (Stage Two) through the side slopes (saturated flow). One flow direction or the other will predominate depending (primarily) on:

- The depths to the water table and confining unit (i.e., clay or hardpan) below the bottom of the retention BMP, and
- The soil's saturated hydraulic conductivity.

The following paragraph briefly describes the two stages of infiltration, and subsequent subsections present accepted methodologies for calculating infiltration rates and recovery times for unsaturated vertical (Stage One) and saturated horizontal (Stage Two) flow.

Initially, the subsurface conditions are assumed to be:

- The depth to the initial water table below the bottom of the BMP.
- Unsaturated soils above the water table.

When the water begins to infiltrate, it is driven downward as unsaturated flow by the combined forces of gravity and capillary action. Once the unsaturated soil below the BMP becomes saturated (fills the voids in the soil), the water table begins to "mound" (refer to Figure A.1.1)

Figure A.1.1. Ground Water Mounding Beneath a Retention System

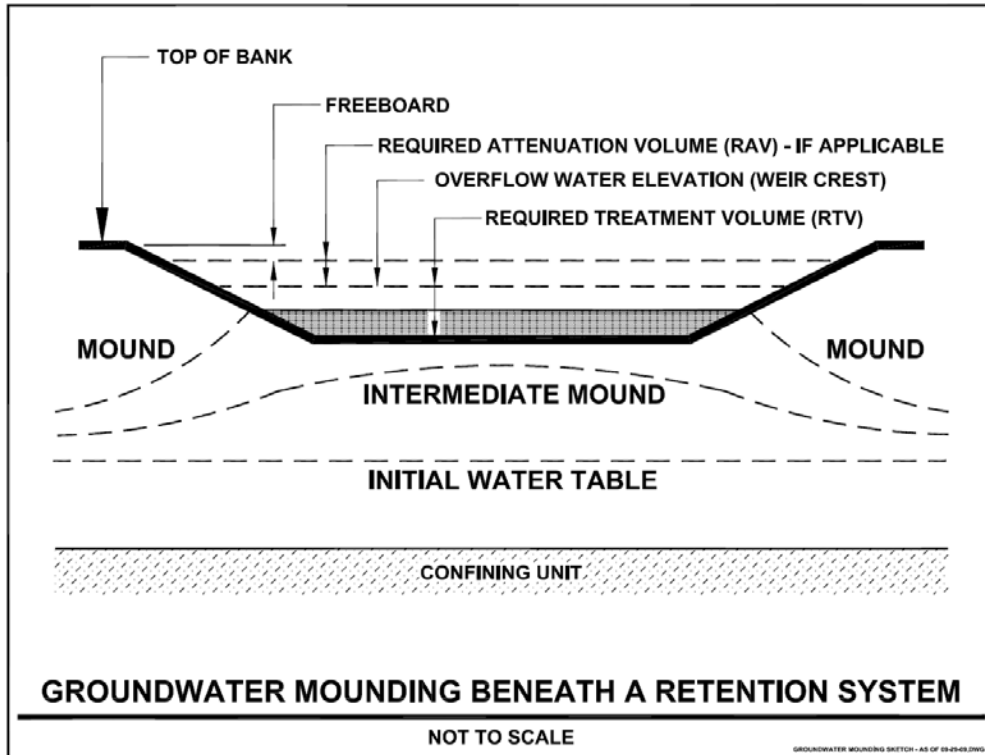

B.1.5. Accepted Methodologies for Determining Retention BMP Recovery

A. Acceptable methodologies for calculating retention BMP recovery are presented below in Table B.1.1.

Vertical Unsaturated Flow	Horizontal Saturated Flow
Green and Ampt Equation	Simplified Analytical Method
Hantush Equation	PONDFLOW
Horton Equation	Modified MODRET
Darcy Equation	
Holton Equation	

Several of these methodologies are available in commercial software products. The Agencies can neither endorse any software program nor certify software results.

B. Additional requirements for calculating retention BMP recovery

Unless the normal Seasonal High Ground Water Table (SHGWT) is greater than or equal to 2 feet below the bottom of the BMP system, unsaturated vertical flow prior to saturated horizontal mounding shall be conservatively ignored in the recovery analyses. This is not an unrealistic

assumption since the height of the capillary fringe in fine sands is on the order of six (6) inches, and a partially mounded water table condition may be remnant from a previous storm event.

B.1.6. Requirements, Guidance and Recommendations for Manual Computations or Computer Simulations

Practicing engineers and hydrogeologists routinely uses computer-based ground water flow models to predict the time for percolation of the Required Treatment Volume (RTV). The reliability of the output of these models cannot exceed the reliability of the input data. Input data assessment is probably the most neglected single task in the ground water modeling process. The accuracy of computer simulations hinges on the quality and completeness of the input data.

The computer models listed in the previous section require input values of the retention BMP dimensions, retained stormwater runoff volume (the RTV) and the following set of aquifer parameters:

- Thickness or elevation of base of mobilized (or effective) aquifer
- Weighted horizontal saturated hydraulic conductivity of mobilized aquifer
- Fillable porosity of mobilized aquifer
- Ambient water table elevation which, for design purposes, is usually the normal Seasonal High Ground Water Table (SHGWT)

Calculated recovery times are most sensitive to the input value for the aquifer's **saturated hydraulic conductivity**.

A. Determination of Aquifer Thickness

Standard Penetration Test (SPT) borings are recommended for definition of the aquifer thickness, especially where the ground water table is deep. This type of boring provides a continuous measure of the relative density/consistency of the soil (as manifested by the SPT "N" values). A relative density - texture (-200 value) better identifies an aquitard or confining unit.

Manual "bucket" auger borings (when supplemented with classification testing) can also be used to define the thickness of the uppermost aquifer (i.e., the depth to the confining unit), especially for small retention ponds and swales.

Definition of SPT "N" Values

The Standard Penetration Test (SPT) consists of driving a split-barrel sampling "spoon" or sampler a distance of 30 cm (12 in) after first "seating" the sampler 15 cm (6 in) by dropping a 63.5 kg (140 lb.) hammer from a height of 76 cm (30 in). In field practice, the sampler is driven to a designated depth through a borehole using a long rod, and the hammer strikes the top end of the rod above the ground surface. The operator counts the number of blows that it takes to advance the sampler each of three 15 cm (6 in) increments. When the sampler has penetrated 45 cm (18 in) into the soil at the bottom of the borehole, the operator adds the number of blows for the second and third increments. This combined number is the result of the SPT and is called the "blow count" and is customarily designated as "N" or the "N value". It directly reflects the penetration resistance of the ground or the soil under investigation.

Definition of a Confining Unit

The confining unit is a hydraulically restrictive layer (i.e., a clay layer, hardpan, etc.). For many recovery / mounding simulations, the confining unit can be considered as a restrictive layer that has a saturated hydraulic conductivity an order of magnitude (10 times) less than the soil strata (sands) above. In some cases, the "Physical & Chemical Properties table" [within the older NRCS soil surveys (legacy documents)] identifies these soil strata as having a vertical hydraulic

conductivity (permeability by NRCS) of 0.06 to 0.6 inches per hour, with the soil above having a permeability of 0.6 to 6.0 inches per hour.

Another method to supplement the identification of a confining unit is to carefully review the SPT boring logs for increases in the SPT "N" values. SPT "N" values (blow counts) alone should be avoided as the primary method to identify a confining unit.

Definition of a Hardpan

A hardpan is a hardened or cemented soil horizon or layer. The soil material is sandy, loamy, or clayey and is cemented by iron oxide, silica, calcium carbonate or other substances.

Definition of a Spodic Horizon

Florida's pine Flatwoods areas typically have a spodic horizon into which organic matter has accumulated. In many cases, this spodic horizon is locally called a hardpan. Pine Flatwoods are the most predominant natural landscape in Florida, comprising approximately 8.4 million acres.

B. Estimated Normal Seasonal High Ground Water Table (SHGWT)

In estimating the normal SHGWT, the contemporaneous measurements of the water table are adjusted upward or downward taking into consideration numerous factors, including:

- Antecedent rainfall
- Soils on the project site.
- Examination of the soil profile, including redoximorphic features, SPT "N" values, depth to "hardpan" or other impermeable horizons (such as clayey fine sands and clays), etc.
- Consistency of water levels with adjacent surface water bodies and knowledge of typical hydraulic gradients (water table slopes).
- Vegetative indicators
- Effects of existing and future development, including drainage ditches, modification of land cover, subsurface drains, irrigation, septic tank drainfields, etc.
- Hydrogeologic setting, including the potentiometric surface of Floridian aquifer and degree of connection between the water table aquifer and the Floridian aquifer.
- Soil Morphological Features

In general, the measurement of the depth to the ground water table is less accurate in SPT borings when drilling fluids are used to maintain an open borehole. Therefore, when SPT borings are drilled, it may be necessary to drill an auger boring adjacent to the SPT to obtain a more precise stabilized water table reading. In poorly drained soils (HSG "B/D" and "D"), the auger boring should be left open, preferably using Piezometer pipe, long enough (at least 24 hours) for the water table to stabilize in the open hole.

If there is ground water relief within the footprint of the pond, the average ground water contour should be considered representative of the pond.

C. Estimation of Horizontal Hydraulic Conductivity of Aquifer

The following hydraulic conductivity tests are required for retention BMPs:

- Laboratory hydraulic conductivity test on an undisturbed sample (constant or falling head)
- Uncased or fully screened auger hole
- Cased hole with uncased or screened extension with the base of the extension at least one (1) foot above the confining layer
- Pump test, when accuracy is important and hydrostratigraphy is conducive to such a test method.

- Slug Test(s)

Of the above methods, the most cost-effective is the laboratory hydraulic conductivity test on an undisturbed horizontal sample. However, it becomes difficult and expensive to obtain undisturbed hydraulic conductivity tube samples under the water table or at depths greater than 5 feet below ground surface.

Pump tests are the most expensive of the recommended hydraulic conductivity test methods. Therefore, it is recommended that pump tests be used in cases where the effective aquifer is relatively thick (greater than 10 feet) and where the environmental, performance, or size implications of the system justifies the extra cost of such a test.

When the aquifer is layered, it is possible to combine several layers and consider the resulting medium as homogenous. If the flow through such layers is mainly horizontal, the arithmetic mean of the hydraulic conductivity estimates of the individual layers should be used to obtain the weighted horizontal hydraulic conductivity of the mobilized aquifer as follows:

$$k_h = \frac{k_1 z_1 + k_2 z_2 + \dots + k_n z_n}{Z}$$

where the formation consists of n horizontal isotropic layers of different thickness z, and Z is the combined thickness. Note that these layers are above the restrictive layer of hardpan or clayey material. Since the most permeable layer will control the value of the weighted hydraulic conductivity, it is important that the hydraulic conductivity of this layer be tested.

For design purposes of all retention BMPs, a saturated hydraulic conductivity value over forty (40) feet per day will not be allowed for fine-grained sands, and sixty (60) feet per day for medium-grained sands.

If the mobilized aquifer is thick with substantial saturated and unsaturated zones, it is worthwhile to consider performing a laboratory permeameter test on an undisturbed sample from the upper unsaturated profile and also performing one of the in-situ tests to characterize the saturated portion of the aquifer.

D. Estimation of Fillable Porosity

In Florida, the receiving aquifer system for retention BMPs predominantly comprises poorly graded (i.e., relatively uniform particle size) fine sands. In these materials, the water content decreases rather abruptly with the distance above the water table and thus has a well-defined capillary fringe.

Unlike the hydraulic conductivity parameter, the fillable porosity of the poorly graded fine sand aquifers in Florida are in a narrow range (20 to 30%), and can be estimated with much more reliability.

For fine sand aquifers, it is therefore recommended that a fillable porosity in the range of 20% to 30% be used in infiltration calculations.

The higher values of fillable porosity will apply to the well- to excessively-drained, hydrologic group "A" fine sands, which are generally deep, contain less than 5% by weight passing the U.S. No. 200 (0.074 mm) sieve, and have a natural moisture content of less than 5%.

No specific field or laboratory testing requirement is recommended, unless there is a reason to obtain a more precise estimate of fillable porosity. In such a case, it is recommended that the following equation be used to compute the fillable porosity:

$$\text{Fillable porosity} = (0.9 N) - (w \gamma_d / \gamma_w)$$

Where N = total porosity

W = natural moisture content (as a fraction)

γ_d = dry unit weight of soil

γ_w = unit weight of water

E. Maximum depth to the SHGWT and confining unit for the required recovery/mounding analysis:

The maximum depths that will be allowed to the SHGWT and the top of the confining unit will be the higher values of:

- The field confirmed SHGWT or confining unit depth(s) from the boring(s) / test pit(s), or
- The termination depth of the field boring / test pit if a SHGWT or confining unit is not encountered.

Requirements and recommendations regarding constructed breaches in the confining unit

- A detention or retention BMP shall not be excavated to a depth that breaches an aquitard such that it would allow for lesser quality water to pass, either way, between the two systems. In those geographical areas where there is not an aquitard present, the depth of the pond shall not be excavated to within two (2) feet of the underlying limestone which is part of a drinking water aquifer.
- Standard Penetration Test (SPT) borings will be required for any type of deep BMP that has the potential for breaching an aquitard.

B.1.7. Requirements, Guidance and Recommendations for BMP Soil Testing

One of the most important steps in the evaluation of a stormwater BMPs is determining which test methods and how many tests should be conducted per system. Typically, soil borings and saturated hydraulic conductivity measurements are conducted for each BMP. Soil testing requirements listed in this Section of the Manual represent the minimum. It is the responsibility of the registered professional to determine if additional soil borings and hydraulic saturated conductivity tests beyond the minimum are needed due to site conditions. Additional tests shall be required if initial testing results deviate to such an extent that they do not provide reasonable assurance that the site conditions are represented by the data provided.

Standard Penetration Test (SPT) borings or auger borings are commonly used to determine the subsurface soil and ground water table conditions. Test borings provide a reasonable soil profile and an estimate of the relative density of the soils. However, measurement of the ground water table depth from SPT borings is usually less accurate than from auger borings. Measurement of hydraulic conductivity requires more specialized tests as described in the previous section.

To measure saturated infiltration, several methods are employed in both the laboratory and in the field. Generally, laboratory tests require collection of an “undisturbed” sample of soil, in either the vertical or horizontal condition, often by means of a Shelby tube. Measurements are performed on the sample via a constant head or falling head condition in a laboratory permeameter. Other methods that involve “remolding” of the soil sample are generally not as accurate as the undisturbed sample methodology.

Field methods for measuring saturated hydraulic conductivity include auger hole tests, piezometer tests, and pumping tests. Although these tests can be more time consuming, they test a larger volume of soil and generally provide more representative results.

A. Restrictions on the use of double ring infiltrometer tests

The double-ring infiltrometer field test is used for estimating in-situ infiltration rates. If used, these tests must be conducted at the depth of the proposed pond bottom, and shall only be used to obtain the initial “unsaturated” hydraulic conductivity. Once the ground water mound rises to the BMP bottom, the results of a double-ring infiltrometer test are not valid. The rate obtained using the double ring infiltrometer is divided by 2 to obtain the infiltration rate during flowing conditions (e.g. swales).

B. Requirements for soil testing

Information related to soils must include the following:

- Soils test results shall be included as part of a supporting soils/geotechnical report of a project’s ERP application. This report must be certified by the appropriate Florida registered professional.
- For all soil borings that are used to estimate the depth to the Seasonal High Ground Water Table (SHGWT), the soil colors shall be denoted by both their English common name and their corresponding Munsell color notation (i.e., light yellowish brown – 10YR 6/4).
- Soil test locations shall be located on the construction drawings, or as an option, the permit review drawings that are submitted as part of the ERP application to the Agency. The horizontal locations of the soil borings/tests shall be placed on the appropriate plan sheet(s), and vertical locations of the soil borings/tests shall be placed on the appropriate retention BMP cross-section(s). The designation number of each test on the plan or cross-section sheets shall correspond to the same test number in the supporting soils/geotechnical report (i.e., SPT #1, Auger boring #2, hydraulic conductivity test #3, etc.).
- The vertical datum of the soil tests results shall be converted to the same datum of the plan sheets and retention BMP cross-sections. For instance, the geo-technical consultant’s certified report shows the top of the confining unit in SPT #1 as six (6.0) feet Below Land Surface (BLS). The design consultant of record must then convert this BLS data to the vertical datum of the cross-section sheet for the BMP (NGVD29, NAVD88, or another vertical datum specified by the appropriate regulatory agency).

The location and number of soil borings and saturated hydraulic conductivity tests performed are usually based on the various site characteristics and requires considerable professional judgment and experience in the decision process. **At a minimum, the following number of tests will be required for each proposed BMP unless the specific BMP design criteria do not require soil testing:**

The minimum number of required Soil Borings - The greater of the following two criteria:

- One (1) for each BMP, drilled to at least ten (10) feet below the bottom of the proposed BMP system. For instance, if a BMP has a pond bottom 5 feet below existing land surface, the minimum boring depth will be 15 feet below existing land surface.
- For BMPs larger than 0.25 acre, retention systems within Sensitive Karst Areas, complex hydrogeology, appreciable topographic relief under the retention BMP, or areas that been filled or otherwise disturbed to change the site’s soil characteristics such as in certain urban areas or reclaimed mined lands:

$$B = 1 + \sqrt{2A} + \frac{L}{2\pi W}$$

Where:

B = number of required borings under each retention BMP, drilled to at least ten (10) feet below the bottom of the proposed BMP system. For instance, if a retention pond has a pond bottom 5 feet below existing land surface, the minimum boring depth will be 15 feet below existing land surface (rounded up or down to the next whole number).

A = average BMP area in acres (measured at the control elevation)

L = length of the BMP in feet (length is the longer of the dimensions)

W = width of the BMP, in feet

π = PI, approximately 3.14

For swales, a minimum of one boring shall be taken for each 500 linear feet or for each soil type that the swale will be built on.

For the recovery / mounding analysis, SPT borings should be continuously sampled at least two (2.0) feet into the top of the hydraulically restrictive layer. If a restrictive layer is not encountered, the boring shall be extended to at least ten (10) feet below the bottom of the pond / system. As a minimum, the depth of the exploratory borings should extend to the base elevation of the aquifer assumed in analysis, unless nearby deeper borings or well logs are available.

Minimum number of required Saturated Hydraulic Conductivity tests - At a minimum, the following number of tests will be required for each proposed BMP unless the specific BMP design criteria do not require saturated hydraulic conductivity testing. The greater of the following two criteria:

- One (1) for each BMP, taken no shallower than the proposed bottom of the BMP system, or deeper if determined by the design professional to be needed for the particular site conditions. However, if the system will be built on excessively drained soils, the applicant may propose a lesser number of tests based on plans, test results, calculations or other information, that the number of tests is appropriate for the specific site conditions.
- For BMPs larger than 0.25 acre, retention systems within Sensitive Karst Areas, complex hydrogeology, appreciable topographic relief under the retention BMP, or urbanized (or reclaimed mining) areas that have undergone previous soil disturbance:

$$P = 1 + (B / 4)$$

Where:

P = number of saturated hydraulic conductivity tests for each retention BMP, taken no shallower than the proposed bottom of the retention system, or deeper if determined by the design professional to be needed for the particular site conditions (rounded up or down to the next whole number). However, if the system will be built on excessively drained soils, the applicant may propose a lesser number of tests based on plans, test results, calculations or other information, that the number of tests is appropriate for the specific site conditions.

For wet detention, stormwater harvesting, or underdrain BMPs that have the potential for impacting adjacent wetlands or potable water supply wells, the hydraulic conductivity tests will be required between the location of the BMP and the adjacent wetlands or well.

B.1.8. Sediment Sump Design Example

A horizontal-flow sump or sediment basin must remove the particles under peak flow conditions. The length of the sediment sump or basin will be governed by the depth required by the settling velocity of the particle, and the cross-sectional area will be governed by the rate of flow.

A length to depth ratio for the sediment sump or basin can be calculated:

$$\text{Flow through velocity (V}_d\text{)} = \frac{\text{length of sump (l)} \times \text{Settling velocity (V}_s\text{)}}{\text{depth of sump (h)}}$$

The cross-sectional area (A) required for peak flow (Q_p) at a flow through velocity (V_d):

$$Q_p = A V_d$$

$$A = \frac{Q_p}{V_d}$$

The cross-sectional area (A) is the width of the sump (W) multiplied by the depth of the sump (h):

$$A = Wh$$

The sump can be sized using these equations:

$$l = \frac{V_d h}{V_s}$$

$$Q_p = V_d Wh$$

Where:

- Q_p = design peak rate of flow
- V_d = flow through velocity
- V_s = settling velocity
- l = length of sump
- W = width of sump
- h = depth of sump

V_s is the settling velocity for a discrete particle using Stokes Law:

$$V_s = \frac{gd^2(S_s - 1)}{18\gamma}$$

Where:

- V_s = settling velocities
- S_s = specific gravity of particle
- γ = kinematic viscosity
- d = diameter of particle
- g = acceleration due to gravity

Remember that the Reynolds number for flow must be less than one for Stokes Law to apply.

Given the following, calculate the settling velocity, the flow through velocity and the sump dimensions:

- $d = 0.01$ cm sand particle
- $S_s = 2.65$ for sand particle
- $\gamma = 1.31 \times 10^{-2}$ cm²/sec with water at 20°C
- $g = 981$ cm/sec²

$$V_s = \frac{981 * 0.01^3 * (2.65 - 1)}{18 * 1.31 * 10^{-2}} = 0.69 \frac{cm}{sec}$$

$$V_s = \frac{0.69 \text{ cm}}{s} \left(\frac{0.3937 \text{ in}}{cm} \right) \left(\frac{1 \text{ ft}}{12 \text{ in}} \right) = 0.23 \frac{ft}{s}$$

V_d is the flow through velocity which must be less than the velocity required to transport the design particle:

$$V_d = \frac{8 K'}{f} g d (S_s - 1)$$

$$V_d = \left(\frac{8(0.06)}{0.03} \right) (32.2) \left(\frac{0.00394}{12} \right) (2.65 - 1) = 0.26 \frac{ft}{s}$$

- Where:
- $V_d =$ velocity required to transport water born particle
 - $d =$ diameter of the particle = 0.01 cm = 0.0394 inches
 - $f =$ Darcy-Weisbach friction factor = 0.03
 - $K' =$ Cohesiveness factor of particle = 0.06
(clean grit = 0.04, sticky = 0.8)
 - $S_s =$ Specific gravity of particle = 2.65
 - $g =$ acceleration due to gravity = 32.2 ft/sec²

To determine the sediment sump dimensions given the following:

- $V_d = 0.26$ ft/sec $l = (h V_d)/V_s$
- $V_s = 0.023$ ft/sec
- $Q_p = 25$ cfs $w = Q_p/(h V_d)$

By fixing one of the variables (w, h, l), the others can be calculated:
If h = 3.5 feet, then:

$$l = \frac{h V_d}{V_s} = \frac{3.5 * 0.26}{0.023} = 39.56 \text{ ft}$$

$$w = \frac{Q_p}{h V_d} = \frac{25}{3.5 * 0.26} = 27.47 \text{ ft}$$

APPENDIX C: ESCAMBIA COUNTY SURFACE WATERS

This appendix contains a list of all of the surface waters in Escambia County for which the FDEP has assigned a water body identification (WBID) number. The table also indicates whether a water body has been verified as an Impaired Water Body, whether an Impaired Water Body has had a Total Maximum Daily Load adopted for the impairment, and whether a Basin Management Action Plan (BMAP) has been developed and adopted to establish a framework for reducing pollutant loading so that the water body will meet its applicable water quality standards and beneficial uses. This information is correct as of September 2016. For more recent information, please use the web sites listed in Section 2.3.5 of this Manual.

All WBID mercury impairments that were associated with fish tissue are not included in the list of impairments since stormwater discharges are not a source of mercury. In addition, the DEP has adopted a statewide Mercury TMDL to address the issue.

Appendix C. List of ESCAMBIA County Receiving Waters and their Current Impairment Status, TMDL Status, BMAP Status.
 The following table lists the receiving waters in Escambia County to which the FDEP has assigned [Water Body Identification \(WBID\)](#) numbers. For WBIDS that are not meeting applicable [water quality standards](#), the table includes their impairment status and whether a [Total Maximum Daily Load](#) or [Basin Management Action Plan](#) has been adopted for the impaired water body. This list is current as of September 2016. For more recent information, please see the web sites in [Section 2.3.5](#) of the Manual.

WATER BODY	WBID NO.	WATER TYPE	IMPAIRED STATUS	POLLUTANT OF CONCERN	TMDL STATUS	TMDL % REDUCTION	BMAP STATUS
ALLIGATOR CREEK	245	STREAM					
BAY BLUFFS PARK	548BB	BEACH	Verified	Bacteria – beach advisories			
BAYOU CHICO	846	ESTUARY	Verified	Fecal coliform Nutrients – Chlorophyll a	FC TMDL TN TP TMDL	61% 30%, 30%	FC BMAP adopted October 2011
BAYOU CHICO BEACH	846CB	BEACH	Verified	Bacteria – beach advisories	FC TMDL	61%	
BAYOU CHICO DRAIN	846C	ESTUARY	Verified	Fecal coliform Nutrients	TN TP TMDL	61% 30%, 30%	
BAYOU GARCON	987	ESTUARY					
BAYOU GRANDE	548F	ESTUARY	Verified	Fecal coliform			
BAYOU GRANDE	740	ESTUARY					
BAYOU MARCUS	697	STREAM	Verified	DO – nutrients TN			

CREEK							
BAYVIEW PARK PIER	738AB	BEACH	Verified	Bacteria – beach advisories			
BEAVERDAM CREEK	6	STREAM					
BELLSHEAD BRANCH	779	STREAM					
BEULAH DRAIN	616	STREAM					
BIG ESCAMBIA CREEK	10	STREAM					
BIG LAGOON	1004	ESTUARY					
BIG LAGOON STATE PARK	8001C	BEACH	Verified	Bacteria – beach advisories			
BLACK BRANCH	217	STREAM					
BLACK LAKE	696	LAKE					
BLACK LAKE DRAIN	696A	STREAM					
BLUE WATER CREEK	192	STREAM					
BOGGY CREEK	135	STREAM					
BOGGY CREEK (WEST FORK)	182	STREAM					
BOWMAN CREEK	311	STREAM					
BREASTWORKS BRANCH	39	STREAM					
BRIDGE CREEK	872A	STREAM					

BRIDGE CREEK (TIDAL PORTION)	872B	ESTUARY	Verified	Fecal coliform			
BRUSHY CREEK	4	STREAM	Verified	Fecal coliform	FC TMDL	64%	
BUCKEYE BRANCH	169	STREAM					
CANOE CREEK	7	STREAM					
CARPENTER CREEK	676	STREAM	Verified	Fecal coliform	FC TMDL	28%	
CHURCHHOUS E BRANCH	357	STREAM					
CLAYPIT BRANCH	607	STREAM					
CLEAR CREEK	531	STREAM					
COFFEE CREEK	489B	STREAM					
COTTON CREEK	131	STREAM					
COUNTY PARK EAST	8004C	BEACH					
COUNTY PARK WEST	8003C	BEACH					
COWDEVIL CREEK	345	STREAM					
COWHIDE CREEK	278	STREAM					
CRESCENT LAKE	697A	LAKE					

DIRECT RUNOFF TO BAY	1007	STREAM					
DIRECT RUNOFF TO BAY	1014	ESTUARY					
DIRECT RUNOFF TO BAY	1018	ESTUARY					
DIRECT RUNOFF TO BAY	639	STREAM	Verified	Fecal coliform			
DIRECT RUNOFF TO BAY	666	ESTUARY					
DIRECT RUNOFF TO BAY	740A	STREAM					
DIRECT RUNOFF TO BAY	763	STREAM					
DIRECT RUNOFF TO BAY	848	STREAM					
DIRECT RUNOFF TO BAY	870	STREAM					
DIRECT RUNOFF TO BAY	871	STREAM					
DIRECT	925	ESTUARY					

RUNOFF TO BAY							
DIRECT RUNOFF TO BAY	974	ESTUARY					
DIRECT RUNOFF TO BAY	991	ESTUARY					
DIRECT RUNOFF TO GULF	1015	STREAM					
DIRECT RUNOFF TO GULF	930	ESTUARY					
DRY CREEK	290	STREAM					
EIGHTMILE CREEK	624	STREAM					
ELEVENMILE CREEK	489	STREAM	Verified	Fecal coliform DO – BOD DO - nutrients	FC TMDL	63% - 66%	
ESCAMBIA BAY	548A		Verified	Nutrients – historic chlorophyll a			
ESCAMBIA BAY (NORTH SEGMENT)	548AA	ESTUARY	Verified	Nutrients – historic chlorophyll a	TN TP TMDL	0%, 35%	
ESCAMBIA BAY (SOUTH SEGMENT)	548B	ESTUARY	Verified	Fecal coliform Bacteria (shellfish)			
ESCAMBIA BAY NORTH	548AC	ESTUARY	Verified	Nutrients – historic chl a Bacteria -shellfish			

(SHELLFISH)							
ESCAMBIA RIVER	10A	STREAM					
ESCAMBIA RIVER	10B	STREAM					
ESCAMBIA RIVER	10C	STREAM					
ESCAMBIA RIVER	10D	STREAM					
ESCAMBIA RIVER	10E	STREAM					
ESCAMBIA RIVER	10F	ESTUARY	Verified	Fecal coliform	FC TMDL	5%	
FARM HILL RUN	407	STREAM					
FLETCHER CREEK	201	STREAM					
FORT PICKENS	8002A	BEACH					
FREEMAN SPRINGS BRANCH	105	STREAM					
GARCON POINT	548CB	BEACH					
GULF OF MEXICO	8001	COASTAL					
GULF OF MEXICO	8002	COASTAL					
GULF OF MEXICO	8003	COASTAL					

GULF OF MEXICO	8004	COASTAL					
GULF OF	8005	COASTAL					
GULLY BRANCH	237	STREAM					
HALL BRANCH	79	STREAM					
HELVERSON CREEK	148	STREAM					
HOBBS BRANCH	8	STREAM					
HOLLAND BRANCH	102	STREAM					
HUBBARD CREEK	14	STREAM					
HURST BRANCH	681	STREAM					
ICWW	1004C	ESTUARY					
JACKS BRANCH	291	STREAM			EPA TMDL TN TP BOD	44% 42% 29%	
JACKSON CREEK	846B	STREAM	Verified	Fecal coliform	FC TMDL	61%	
JACKSON SPRINGS BRANCH	228	STREAM					
JOHNSON BEACH	8001B	BEACH					

JOHNSON BEACH (SOUND SIDE)	1004A	BEACH					
JONES CREEK	846A	STREAM	Verified	Fecal coliform	FC TMDL	61%	
LAKE STONE (SOUTHWEST OF CENTURY)	25A	LAKE					
LITTLE PINE BARREN CREEK	87	STREAM					
MCDADE CREEK	208	STREAM					
MCDAVID CREEK	149	STREAM	Verified	Fecal coliform			
MILL CREEK	10AA	STREAM					
MITCHELL CREEK	71	STREAM					
MORGAN BRANCH	265	STREAM					
MUSCOGEE CREEK	494	STREAM					
NARROW GAP BRANCH	197	STREAM					
NAVY POINT	548FB	BEACH	Verified	Bacteria – beach advisories			
PENASULA CREEK	297	STREAM					
PENSACOLA BAY(NORTH SEGMENT)	548C	ESTUARY	Verified	Bacteria - shellfish			

PENSACOLA BAY (MIDDLE SEGMENT)	548D	ESTUARY					
PENSACOLA BAY (MOUTH)	548E	ESTUARY					
PENSACOLA BEACH	8003E	BEACH					
PERDIDO BAY (LOWER SEGMENT)	797A	ESTUARY					
PERDIDO BAY (UPPER SEGMENT)	797	ESTUARY					
PERDIDO KEY STATE PARK	8001A	BEACH					
PERDIDO RIVER (MIDDLE A)	72D	STREAM					
PERDIDO RIVER (MIDDLE B)	72	STREAM					
PERDIDO RIVER (MIDDLE C)	462C	STREAM					
PERDIDO RIVER (NORTH A)	2F	STREAM					
PERDIDO RIVER (NORTH B)	72F	STREAM					
PERDIDO	72E	STREAM					

RIVER (NORTH C)							
PERDIDO RIVER (SOUTH FRESH)	462B	STREAM	Verified	Fecal coliform			
PERDIDO RIVER (SOUTH MARINE)	462A	ESTUARY					
PINE BARREN CREEK	5	STREAM					
POND BRANCH	259	STREAM					
PRETTY BRANCH	342	STREAM					
PRITCHELL MILL BRANCH	9	STREAM					
QUIET WATER BEACH	915E	BEACH					
REEDY BRANCH	172	STREAM					
REEDY BRANCH	3	STREAM					
REST AREA RUN	542	STREAM	Verified	Fecal coliform			
ROCKY BRANCH	374	STREAM					
ROCKY CREEK	138	STREAM					
SABINE YACHT AND RACKET	8003D	BEACH					
SANDERS	848DA	BEACH	Verified	Bacteria – beach	FC TMDL	61%	

BEACH				advisories			
SANTA ROSA ISLAND PARK	8004B	BEACH					
SANTA ROSA SOUND	915	ESTUARY	Verified	Fecal coliform Bacteria –shellfish			
SCHOOLHOUSE BRANCH	243	STREAM					
SPANISH MILL CREEK	475	STREAM					
STILL BRANCH	252	STREAM					
TARKILN BAYOU	945	ESTUARY	Verified				
TEE AND WICKER LAKES	784	ESTUARY	Verified				
TENMILE CREEK	489A	STREAM	Verified	Fecal coliform	FC TMDL	42.9%	
TEXAR BAYOU	738	ESTUARY	Verified	Fecal coliform	FC TMDL	49%	
THE CANAL	341	STREAM					
THOMPSON BAYOU	586	STREAM					
TURNER CREEK	730	STREAM					
UNNAMED BRANCH	134	STREAM					
UNNAMED BRANCH	725	STREAM					
UNNAMED BRANCH	73	STREAM					

WEEKLY BAYOU	935	ESTUARY					
WIGGINS BRANCH	25	STREAM					
WILDER BRANCH	326	STREAM					
WILLIAMS CREEK	395	STREAM					

DSM Professional Advisory Committee

3. C.

Meeting Date: 11/07/2016

Submitted By: Allyson Cain, Development
Services

Information

Recommendation:

Department checklist for preliminary plats and final plats.

Attachments

Departmental checklist language

1 **Sec. 2-4.3 Minor site development.**

2 **(a) General.** Minor site plan approval is required to authorize those land uses or
3 development activities categorized as a “minor site development” in this section.
4 The process to approve a minor site development evaluates uses and activities that
5 typically produce fewer and/or less complex LDC compliance conditions than major
6 development. As a result, compliance usually requires less documentation and
7 fewer resources to confirm. Minor review primarily verifies that the use is permitted,
8 the lot conforms, structures are appropriately placed, site access is adequate, public
9 facilities are provided, and no adverse off-site impacts are created.

10 **(b) Categories of minor development.** Minor site development is limited to the
11 following categories:

12 **(1) Single-family and two-family residential.** Residential site development is a
13 combination of single-family and two-family dwellings that results in no more than
14 four dwelling units on a lot. The category includes all uses and structures
15 customarily accessory to such dwellings, including fences, enclosures, swimming
16 pools, carports, and portable storage containers, and the conversion of a non-
17 residential building to a one- or two-family dwelling.

18 **(2) Non-residential change of use.** Change of use in which the site development
19 changes any non-residential use of a non-residential structure or site to another
20 non-residential use, provided that any additional trip generation is minor and
21 modifications are limited to those of the minor non-residential and minor multi-
22 family category in this section. For these purposes, minor trip generation
23 corresponds to a less than a 25 percent increase in the minimum parking
24 required by the applicable unmodified base parking ratios in Chapter 5 and the
25 DSM.

26 **(3) Temporary non-residential.** Temporary establishment of a non-residential use
27 or structure including portable storage containers, portable shelters, mobile
28 vending units, amusement structures, temporary constructions, sales offices, and
29 other temporary uses and structures prescribed in Chapter 4.

30 **(4) Minor non-residential and multi-family.** Minor additions and modifications and
31 accessory uses and structures for existing non-residential or multi-family
32 development if the net increase in site impervious cover from all sources is less
33 than 1000 square feet. Repeated additions of impervious surface constructed
34 since the adoption of the LDC shall be combined for the application of this limit.
35 Accessory uses include fences and signs.

36 **(c) Approval process.**

37 Checklists provided by the appropriate department will give the applicant quick and
38 ready access to the individual requirements of each department as they pertain to this
39 article

1 **Sec. 2-4.4 Major site development.**

2 **(a) General.** Major site plan approval is required to authorize those land uses or
3 development activities categorized as a “major site development” in this section.
4 The process to approve a major site development evaluates uses and activities that
5 typically produce greater or more complex LDC compliance conditions than minor
6 development.

7 **(b) Categories of major review.** Major site development is limited to the following
8 categories:

9 **(1) Multi-family residential.** Residential site development in which there are five or
10 more dwelling units in any combination on a lot. This category includes uses and
11 structures customarily accessory to multi-family developments, such as fences,
12 swimming pools, carports, mail kiosks, maintenance sheds, and clubhouses
13 when they are not eligible for review as minor site developments. The
14 conversion of a non-residential building into a multi-family dwelling is included in
15 this category.

16 **(2) Residential change of use.** Change of use in which the site development
17 changes any residential use of a structure to any non-residential use, in whole or
18 part. This category applies to any principal or accessory residential structure but
19 does not apply to home occupations or home-based businesses as defined by
20 the LDC.

21 **(3) Major non-residential.** New principal and accessory uses and structures not
22 reviewed by any other non-residential review category.

23 **(4) Master plans.** Master plans for phased site development are intended to
24 provide the developer with confirmation that the development is properly planned
25 according to the regulations and standards of the LDC. The Master Plan ensures
26 integration with the surrounding land uses and development and the sufficiency
27 of the supporting infrastructure at the completion of each phase.

28 **(5) PUDs.** Planned Unit Development (PUD) submitted under the PUD provisions of
29 Article 6.

30 If all the applicable regulations concerning the proposed project for a PUD are
31 met, a Development Order shall be issued, with or without conditions, by the
32 approving authority that shall be a continuing obligation to comply with the
33 specifications of the plan and the terms and conditions of that approval.

34 **(c) Approval process.**

35 Checklists provided by the appropriate department will give the applicant quick
36 and ready access to the individual requirements of each department as they
37 pertain to this article.

38
39 **Sec. 2-5.3 Minor subdivisions.**

40 **(a) General.** Minor subdivision approval is a limited option for the subdivision of land
41 where the final plat is not recorded in the public records of the county and is not

1 subject to the platting requirements of Florida statutes. One of the requirements is
2 that the supporting infrastructure is already in place. A minor subdivision shall fulfill
3 all of the following criteria:

4 **(1) Number of lots.** If any subdivision lots are less than four acres on an existing
5 public or private street, the maximum number of lots that can be created is five.

6 **(2) Existing street frontage.** All subdivision lots front on an existing public or
7 private street, paved or unpaved, providing the minimum right-of-way prescribed
8 in Chapter 5.

9 **(3) No new streets.** No new street or any extension of an existing street is
10 proposed or required.

11 **(4) No dedications.** There is no dedication of public improvements. This does not
12 preclude such acquisitions as an additional right-of-way for an existing street to
13 provide the minimum width prescribed by the LDC.

14 **(5) Lot grading plans.** A lot grading plan is required for each lot however a
15 stormwater management plan may not be required.

16 **(6) Effective period.** Approved minor subdivisions shall be effective and remain
17 valid for period of 1 year from the date of approval. The minor subdivision plat
18 shall expire and be void if each of the newly created lots are not recorded by
19 deed or other legal instrument in the official records of Escambia County within
20 the valid period of approval.

21 **(b) Approval process.**

22 Checklists provided by the appropriate department will give the applicant quick and
23 ready access to the individual requirements of each department as they pertain to this
24 article

25
26 **Sec. 2-5.4 Master plans.**

27 **(a) General.** Master plans approval is required for any phased subdivision of land. A
28 master plan is intended to provide the developer with confirmation that the
29 subdivision is properly planned according to the regulations and standards of the
30 LDC. The Master Plan ensures integration with the surrounding land uses and
31 development and the sufficiency of the supporting infrastructure at the completion of
32 each phase Master Plan approval vests the approved land uses and density, but it
33 does not reserve development standards, guarantee buildable density, nor assure
34 approval of any implementing plats or construction plans. Each implementing phase
35 requires submission of a preliminary plat, construction plan, and final plat.

36 **(b) Approval process.**

37 Checklists provided by the appropriate department will give the applicant quick and
38 ready access to the individual requirements of each department as they pertain to
39 this article.

1 **Sec. 2-5.5 Preliminary plats.**

2 **(a) General.** Preliminary plat approval is required to map the proposed subdivision of
3 land and to ensure the division of land meets all the land use regulations of the LDC.

4 **(b)** Preliminary plat can be submitted separate or at the same time the construction
5 plans are submitted. The approved preliminary plat reserves the density applied for.
6 Each phase of a subdivision requires submission of a preliminary plat.

7 **(c) Approval process.**

8 Checklists provided by the appropriate department will give the applicant quick and
9 ready access to the individual requirements of each department as they pertain to
10 this article.

11 **Sec. 2-5.6 Construction Plans**

12 **(a) General.** Construction plan approval is required to document the design of
13 infrastructure to adequately serve the created lots. Infrastructure capacities will be
14 allocated upon final development plan approval. The approval allows the
15 construction of the subdivision infrastructure to proceed, but it does not allow
16 development on the individual subdivision lots prior to the recording of a final plat,
17 except for temporary uses as specifically provided in Chapter 4.

18 **(b)** Construction plans must be submitted within two years of the preliminary plat
19 approval. Plans may be submitted concurrently with the preliminary plan, at the
20 discretion of the applicant. If the construction plans show substantial deviations from
21 the approved preliminary plat, the applicant must submit a revised preliminary plat
22 prior to construction plan approval.

23 **(c) Substantial deviations.** Deviations shall be determined by the Planning Official
24 and/or the County Engineer. Deviations may include but not limited to the following:

- 25 (1) Any increase in the number of lots proposed.
26 (2) Significant re-alignment of proposed roadway.
27 (3) Increased impacts to public services (sanitary sewer, potable water, solid
28 waste.)
29 (4) Revised location of roadway connection to county road.

30 **(d) Approval process.**

31 Checklists provided by the appropriate department will give the applicant quick and
32 ready access to the individual requirements of each department as they pertain to
33 this article..

34 **Sec.2-5.7 Final plats**

35 **(a) General.** Final plat approval is required to map the proposed subdivision of land in
36 compliance with the platting requirements of Florida Statutes, so that, upon its
37 recording, all land shown on the plat that is a part of the subdivision is identified and
38 may be conveyed by reference to the plat, including the dedication of rights-of-way
39 and easements. The approval of a final plat allows the recording of the plat in the
40 public records when its content and form are consistent with state and county
41 requirements and with any applicable conditions of its approved preliminary plat and
42 infrastructure construction plan.

1 **(b) Application for the final plat.** Applicants seeking final plat approval from the Board
2 of County Commissioners shall submit their request to the Office of the Planning
3 Official. Applications shall be submitted within two years of the date that the
4 preliminary plat and construction plans were approved unless an extension is
5 granted as provided in Chapter 2.

6 **(c) Warranty agreement.** Applicants seeking final plat approval shall warrant that all
7 public subdivision improvements are built in accordance with approved construction
8 plans and free from design, construction, material, and workmanship defects for a
9 period of two years from the date that the final plat is recorded. The applicant shall
10 make the warranty on a form of warranty agreement published by the County.

11 **(d) Incidental deficiencies.** At the discretion of the County Engineer, final plats may
12 be submitted to the Board of County Commissioners for approval with minor defects
13 to public subdivision improvements that are determined to be incidental deficiencies.
14 Incidental deficiencies are primarily cosmetic in nature and do not undermine the
15 function or stability of the public subdivision improvements. Incidental deficiencies
16 include but are not limited to the following:

17 **(1)** Cracked curbing or other cracked concrete that is not destroyed or displaced but
18 still functions for the intended use.

19 **(2)** Minor ponding of water on asphalt, provided base failure is not evident.

20 **(3)** Minor settling of asphalt areas, provided base failure is not evident.

21 **(4)** Minor defects in stormwater pipe, provided installation is in accordance with the
22 manufacturers' requirements.

23 **(5)** Ponds recharging at a slow rate, but still meeting regulatory requirements.

24 **(6)** Seed or sod that has failed to establish sufficient ground cover for final
25 stabilization and erosion control.

26 Incomplete installation of street signs and pavement markings shall not be
27 considered incidental deficiencies. If incidental deficiencies exist when the final plat
28 is submitted for approval by the Board of County Commissioners, the applicant shall
29 also include financial security with the executed warranty agreement.

30 **(e) Acceptable forms of financial security.** Financial security shall be in the form of a
31 cash deposit or irrevocable letter of credit. The cash deposit shall be held in an
32 interest-bearing account with withdrawals conditions upon approval of the County
33 Administrator. Interest on cash deposits shall be retained by the applicant only if the
34 applicant satisfactorily corrects all incidental deficiencies guaranteed by the deposit.

35 **(f) Amount of financial security.** If financial security is required, the applicant shall
36 provide an estimate from the engineer of record for the cost to remove and replace
37 all public subdivision improvements with incidental deficiencies. The amount of the
38 financial security to be provided by the applicant shall be 150% of the cost estimate
39 or \$7,500, whichever is greater.

40 **(g) Warranty inspection.** The County shall inspect all warranted public subdivision
41 improvements prior to the expiration of the two year warranty period and provide to
42 the applicant a list of deficiencies noted during the inspection. The applicant shall
43 remain responsible for correcting any deficiencies noted in the inspection even if the
44 corrective action is not completed until after the expiration of the two year warranty
45 period.

1 **(h) Approval process**

2 Checklists provided by the appropriate department will give the applicant quick and
3 ready access to the individual requirements of each department as they pertain to
4 this article..

5 **(i) Recreational amenities.**

6 For proposed subdivisions that are designed to utilize significant recreational
7 amenities, including but not limited to a golf course, swimming pool, club house or
8 tennis courts, the area designated for those uses shall be included in the final plat.

9 **Sec. 2-5.8 Plat vacation.**

10 **(a) General.** Plat vacation approval is required to vacate a subdivision plat in whole or
11 part after the plat has been recorded in the public records of the county. The
12 approval to vacate a final plat accommodates a replat or a return to acreage for the
13 subject land, according to Chapter 177, Florida Statutes.

14 **(b) Approval process.**

15 Checklists provided by the appropriate department will give the applicant quick and
16 ready access to the individual requirements of each department as they pertain to
17 this article. (Ord. No. 2016-33, § 1, 9-1-2016)

18